

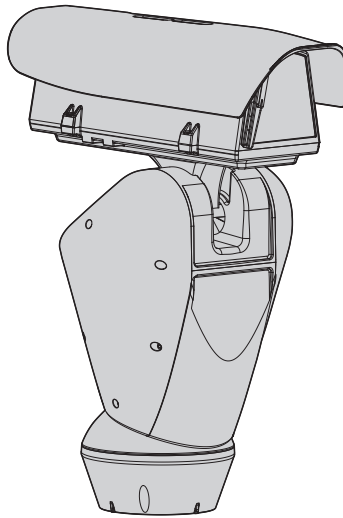

ULISSE PLUS NETCAM

Outdoor Full IP PTZ unit for Network cameras with medium size lenses



EN English - Instructions manual

IT Italiano - Manuale di istruzioni

FR Français - Manuel d'instructions

DE Deutsch - Bedienungsanleitung

RU Русский - Руководство по эксплуатации



ULISSE PLUS NETCAM

Outdoor Full IP PTZ unit for Network cameras with medium size lenses

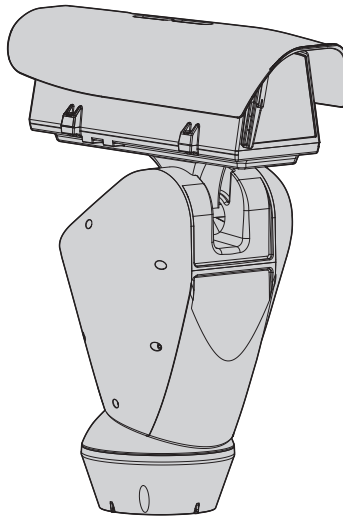

Contents

1 About this manual	7
1.1 Typographical conventions.....	7
2 Notes on copyright and information on trademarks	7
3 Safety rules	7
4 Identification	10
4.1 Product description and type designation.....	10
4.2 Product markings	10
4.2.1 Checking the markings	10
5 Versions	11
5.1 Integrated wiper	11
5.2 LED illuminators	11
5.3 Version with germanium window	11
6 Preparing the product for use	12
6.1 Safety precautions before use.....	12
6.2 Unpacking.....	12
6.3 Contents.....	12
6.4 Safely disposing of packaging material.....	12
6.5 Preparatory work before installation	13
6.5.1 Attaching the bracket	13
6.5.2 Cables management	13
7 Assembly	14
7.6 Assembling the camera and motorised lenses.....	14
7.6.1 Cameras features	14
7.6.1.1 How to open the housing.....	15
7.6.1.2 How to install the camera.....	15
7.6.2 How to install the camera.....	15
7.7 Housing board description	16
7.7.1 Connection of the camera and motorised lens	16
7.7.2 Adjustment of the supply voltage of the lens motors	17
7.7.3 Connection of the communication line	17
8 Installation	18
8.1 Connecting the cables to the base.....	18
8.2 Fixing the base to the support.....	19
8.3 Connector board description.....	19
8.4 Connection of the power supply line.....	20
8.4.1 24Vac power line connection.....	21
8.4.2 120Vac and 230Vac power line connection	21
8.4.3 Connection of the alarm inputs, of the twilight switch and of the relays.....	22
8.5 Connection of the Ethernet cable.....	22
8.6 Fixing the upper body.....	23
8.7 LED illuminators installation	24
8.7.1 Fitting the bracket.....	24

8.7.2 Fitting the illuminator on the bracket.....	24
8.8 Connection of the LED illuminators.....	25
8.9 Desiccant bag.....	26
8.10 Setting of the LED illuminators and synchronization mode with the camera.....	26
8.10.1 Description of the LED illuminator	26
8.10.2 Synchronisation with an external twilight switch.....	27
8.10.3 Synchronising the unit with the LED illuminators	27
8.10.4 Manually activate the LED illuminators	27
8.10.5 LED illuminator switching on threshold adjustment.....	28
8.10.6 LED illuminator power adjustment	28
8.11 Hardware configuration.....	29
8.11.1 Opening the configuration door.....	29
8.11.2 DIP1 configuration.....	29
8.11.3 DIP2 configuration.....	29
8.11.4 DIP3 configuration.....	30
8.11.4.1 Address configuration	30
8.11.4.2 Setting of the serial communication lines	30
8.11.5 DIP4 configuration.....	30
9 Switching on	31
10 Configuration.....	32
10.1 Web interface.....	32
10.1.1 First access.....	32
10.1.2 Home.....	32
10.1.3 User Controls	33
10.1.4 Device Parameters	34
10.1.5 Device Statistics.....	34
10.1.6 Network Configuration	34
10.1.7 User Configuration	35
10.1.8 Movement Parameters.....	35
10.1.8.1 Autopan.....	36
10.1.8.2 Patrol.....	36
10.1.8.3 Motions Recall	36
10.1.9 Preset Parameters	36
10.1.10 Preset Parameters (Advanced).....	36
10.1.11 Digital I/O	37
10.1.12 Washer	37
10.1.13 Camera Parameters.....	38
10.1.14 Tools.....	38
10.1.15 Factory Default.....	39
10.2 VTTunnel	39
11 Accessories.....	40
11.1 Washer.....	40
11.1.1 Washing system connection	40
11.2 Wall mount.....	41
11.3 Parapet bracket.....	41
11.4 Power supply with illuminator control.....	41
12 Instructions for exceptional operation	42

12.1 How to switch from ONVIF communication mode to RS-485 (telemetry) mode	42
12.1.1 How to change communication mode.....	42
13 Maintaining.....	43
13.1 Fuses replacement	43
14 Cleaning	43
14.1 Window and plastic cover cleaning.....	43
14.2 Cleaning the germanium window	43
15 Disposal of waste materials.....	43
16 Troubleshooting	44
17 Technical data	45
17.1 General	45
17.2 Mechanical.....	45
17.3 Electrical	46
17.4 Communications	46
17.5 Protocols.....	46
17.6 Environment.....	46
17.7 Certifications.....	46
18 Technical drawings	47
A Appendix - Address table	50

1 About this manual

Before installing and using this unit, please read this manual carefully. Be sure to keep it handy for later reference.

1.1 Typographical conventions



DANGER!

High level hazard.

Risk of electric shock. Disconnect the power supply before proceeding with any operation, unless indicated otherwise.



DANGER!

Hot surface.

Avoid contact. Surfaces are hot and may cause personal injury if touched.



DANGER!

Mechanical hazard.

Risk of crushing or shearing.



CAUTION!

Medium level hazard.

This operation is very important for the system to function properly. Please read the procedure described very carefully and carry it out as instructed.



INFO

Description of system specifications. We recommend reading this part carefully in order to understand the subsequent stages.

2 Notes on copyright and information on trademarks

The quoted names of products or companies are trademarks or registered trademarks.

3 Safety rules



CAUTION! The electrical system to which the unit is connected must be equipped with a 20A max automatic bipolar circuit breaker. This circuit breaker must be of the Listed type. The minimum distance between the contacts must be 3mm (0.1in). The circuit breaker must be provided with protection against the fault current towards the ground (differential) and the overcurrent (magnetothermal).



CAUTION! Hazardous moving parts. Keep fingers and other body parts away.



CAUTION! The device must be installed only and exclusively by skilled technical personnel.



CAUTION! For continued protection against risk of fire, replace only with same type and rating of fuse. Fuses must be replaced only by service personnel.



CAUTION! TNV-1 installation type. The installation is type TNV-1, do not connect it to SELV circuits.



CAUTION! In order to reduce the risk of fire, only use UL Listed or CSA certified cables sizes greater than or equal to 0.13mm² (26 AWG).

- The manufacturer declines all responsibility for any damage caused by an improper use of the appliances mentioned in this manual. Furthermore, the manufacturer reserves the right to modify its contents without any prior notice. The documentation contained in this manual has been collected with great care. The manufacturer, however, cannot take any liability for its use. The same thing can be said for any person or company involved in the creation and production of this manual.

- Before starting any operation, make sure the power supply is disconnected.
- Do not use cables that seem worn or old.
- Never, under any circumstances, make any changes or connections that are not shown in this handbook. Improper use of the appliance can cause serious hazards, risking the safety of personnel and of the installation.
- Use only original spare parts. Non-original spare parts could cause fire, electrical discharge or other hazards.
- Before proceeding with installation, check the supplied material to make sure it corresponds to the order specification by examining the identification labels (4.2 Product markings, page 10).
- This device was designed to be permanently installed on a building or on a suitable structure. The device must be installed permanently before any operation.
- Installation category (also called Overvoltage Category) specifies the level of mains voltage surges that the equipment will be subjected to. The category depends upon the location of the equipment, and on any external surge protection provided. Equipment in an industrial environment, directly connected to major feeders/short branch circuits, is subjected to Installation Category III. If this is the case, a reduction to Installation Category II is required. This can be achieved by use of an insulating transformer with an earthed screen between primary and secondary, or by fitting listed Surge Protective Devices (SPDs) from live to neutral and from neutral to earth. Listed SPDs shall be designed for repeated limiting of transient voltage surges, suitable rated for operating voltage and designated as follows: Type 2 (Permanently connected SPDs intended for installation on the load side of the service equipment overcurrent device); Nominal Discharge Current (I_n) 20kA min. For example: FERRAZ SHAWMUT, STT2240SPG-CN, STT2BL240SPG-CN rated 120Vac/240Vac, ($I_n=20kA$). Maximum distance between installation and reduction is 5m.
- Use a Class 2 listed UL transformer, compliant with the Standards in force, only for products marked UL, powered at 24Vac.
- A disconnecting device, readily and easily accessible, must be incorporated in the electrical system of the building for rapid intervention.
- The separate protective earthing terminal provided on this product shall be permanently connected to earth.
- Connect the device to a power source corresponding to the indications given on the marking label. Before proceeding with installation make sure that the power line is properly isolated. The supply voltage should never exceed the limit ($\pm 10\%$).
- Power supply must be provided with a SELV type, 24Vac, 8A isolated source derived from a double isolation UL Listed transformer specially protected in output.
- The device should be mounted so that it is accessible only to the technician/installer because the moving parts constitute a residual risk of injury caused by movement of said parts.
- Attach the Dangerous Moving Parts label near the device. (Fig. 5, page 12).
- Do not use the appliance in the presence of inflammable substances.
- To connect the power supply line use the appropriate junction-box (UPTJBUL). For further information, refer to the product use and installation manual.

- Do not allow children or unauthorised people to use the appliance.
- The appliance should only be considered switched off when the power supply has been disconnected and the connecting cables to other devices have been removed.
- Only skilled personnel should carry out maintenance on the device. When carrying out maintenance, the operator is exposed to the risk of electrocution and other hazards.
- Use only the accessories indicated by the manufacturer. Any change that is not expressly approved by the manufacturer will invalidate the guarantee.
- Before connecting all the cables make sure the device is properly connected to the earth circuit.
- If the device has to be removed from the installation, always disconnect the earth cable last.
- Take all necessary precautions to prevent the apparatus from being damaged by electrostatic discharge.
- The unit has been made for connection using a 3-pole cable. To make a correct connection to the earth circuit, follow the instructions in this handbook.
- Handle the unit with great care, high mechanical stress could damage it.
- Make especially sure that the power supply line is insulated at a sufficient distance from all the other cables, including lightning protection devices.
- If it is necessary to transport the device, this should be done with great care. Abrupt stops, bumps and violent impact could damage the unit or injure the user.

4 Identification

4.1 Product description and type designation

ULISSE PLUS NETCAM is a powerful Full-IP PTZ for outdoor IP video surveillance, which can manage modern IP SD, HD and Megapixel cameras, with integration into a network system.

This model can contain cameras with medium-sized lenses, enabling dynamic and non-stop surveillance of large outdoor areas at 360° degrees.

A special feature of ULISSE PLUS NETCAM is the ability to easily control, via the network, all the camera's pan & tilt functions, including wiper, preset and set-up, using the most common VMS on the market. It is possible to use any ONVIF compatible Profile S camera, or proprietary protocol on RS-485, whilst the entire management of the system only requires an IP address.

The unit is equipped with a wiper for removing rain and dust from the front glass; there is a wide selection of jerry cans with washer pump, different capacities and heads.

To ensure detailed images even during the night hours, versions are available with LED illuminators, with infrared light or white light.

The accurate top-mount construction ensures vision beyond the horizon and the continuous rotation on the horizontal axis, combining high speed to absolute tracking accuracy, both in manual mode and in patrol mode.

The unit is equipped with optical sensors which ensure the accurate control of the position in any condition of use.

4.2 Product markings

i Pan & tilt devices have a label complying with CE markings.

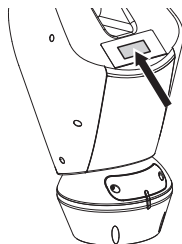

Fig. 1

The label shows:

- Model identification code (Extended 3/9 bar code).
- Power supply (Volt).
- Frequency (Hertz).
- Current consumption (Amps).
- Weatherproof standard (IP).
- Serial number.

4.2.1 Checking the markings

Before proceeding further with installation, make sure the material supplied corresponds to the order specification by examining the marking labels.

Never, under any circumstances, make any changes or connections that are not shown in this handbook. Improper use of the appliance can cause serious hazards, risking the safety of personnel and of the installation.

5 Versions

5.1 Integrated wiper

The product can be equipped with a wiper.

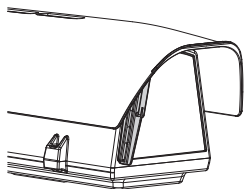

Fig. 2

i For further information refer to the relative chapter (10.1.3 User Controls, page 33).

The P&T can be equipped with an external pump that supplies water for the glass to be cleaned.

i For further information refer to the relative chapter (11.1 Washer, page 40).

5.2 LED illuminators



The version with LED illuminators can only be powered at 24Vac.

The pan & tilt can be fitted with bracket for 2 VIDEOTEC LED illuminators for night surveillance (illuminators not included).

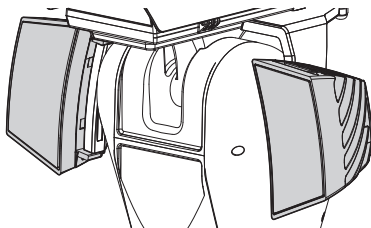

Fig. 3



For further information refer to the relative chapter (8.7 LED illuminators installation, page 24).

5.3 Version with germanium window

The version with germanium window has been developed for applications with thermal cameras.

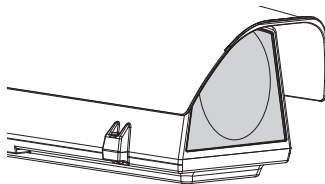

Fig. 4

6 Preparing the product for use



Any change that is not expressly approved by the manufacturer will invalidate the guarantee.



The unit must not be dismantled or tampered with. The only exceptions are those concerning the assembly and maintenance operations stipulated in this manual.

6.1 Safety precautions before use



The appliance includes moving parts. Make sure that the unit is positioned where it is inaccessible under normal operating conditions. Attach the warning label supplied with the appliance, placing it near the unit so that it can be seen easily.



Fig. 5

6.2 Unpacking

When the product is delivered, make sure that the package is intact and that there are no signs that it has been dropped or scratched.

If there are obvious signs of damage, contact the supplier immediately.

Keep the packaging in case you need to send the product for repairs.



Unpack the sunshield of the device, taking care not to damage the housing.

6.3 Contents

Check the contents to make sure they correspond with the list of materials as below:

- Positioning unit
- Power supply base
- Accessories package:
 - Serial adapter
 - Serial extension cable
 - Allen wrenches
 - Spacers (not available in the version with integrated camera)
- Label
- Ties
- Silicon sheath
- Reduction gaskets for cable glands
- Instructions manual
- Attachment plate for desiccant bag (not available in the versions with LED illuminators)
- Desiccant bag
- Bolts and screws
- Bracket for attachment of LED illuminators (available in the versions with LED illuminators)
- Sunshield

6.4 Safely disposing of packaging material

The packaging material can all be recycled. The installer technician will be responsible for separating the material for disposal, and in any case for compliance with the legislation in force where the device is to be used.

When returning a faulty product we recommend using the original packaging for shipping.

6.5 Preparatory work before installation

6.5.1 Attaching the bracket

Different types of supports are available (11 Accessories, page 40). Choose a suitable bracket for the installation and follow all the instructions in the suggested chapter.



Take special care when attaching and fastening down the apparatus. The clamping system must be able to support at least 4 times the weight of the entire equipment, including P&T, lenses and camera.



The device should be assembled vertically. Any other position could impair the performance of the appliance.



Do not attach the device upside down.

6.5.2 Cables management



The connection cables should not be accessible from the outside. It is necessary to fasten the cables securely to the support in order to prevent excessive weight pulling them out accidentally.



You must use cables suited to the type of installation.

Insert the cables into the support so that they protrude by about 50cm.

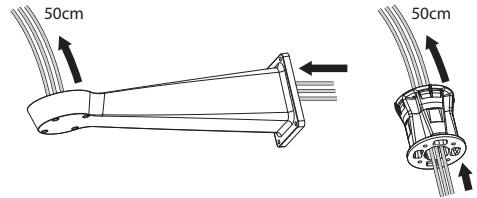

Fig. 6

7 Assembly



Only network cameras with specific technical characteristics can be installed (7.6.1 Cameras features, page 14).

7.6 Assembling the camera and motorised lenses



The correct operation of the equipment, within the temperature range indicated, is guaranteed only if you use camera and lens with temperature limits equal to at least -10°C and + 60°C.

The customer has to take care of assembling the camera and lenses.

7.6.1 Cameras features



The correct operation of the equipment, within the temperature range indicated, is guaranteed only if you use camera and lens with temperature limits equal to at least -10°C and + 60°C.



The camera must be pre-configured in order to acquire the IP address via DHCP.



The camera must be pre-configured in order to interface with the NTP server via DHCP. If NTP configuration via DHCP is not possible, set the following static address of the NTP server: 192.0.0.1.



Only network cameras can be installed in the unit.

- Only cameras with a 100 baseTx type Ethernet communication port can be mounted.
- Only cameras powered by a terminal can be mounted. The Pan & Tilt cannot supply power directly on the Ethernet cable (Power over Ethernet).
- The power supply voltage of the camera must be 12Vdc.
- The maximum absorbed current by the camera must be less than 800mA.
- The communication protocol must be ONVIF, S profile, protocol. The camera must be pre-configured in order to communicate via the ONVIF, S profile, protocol.
- The camera must be operate properly between -10°C (14°F) and +60°C (140°F).

7.6.1 How to open the housing

To open the housing, undo the screws on the sides and lift the upper body.

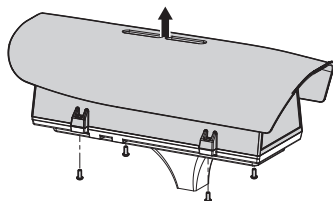

Fig. 7



On removing the upper section of the housing, accompany it until the anchoring cable is taut. Do not drop the upper section of the housing as this could cause the cable to snap.



After installation and wiring, close the product again.

7.6.2 How to install the camera

Take out the inner support slide (01) loosening the fastening screws (02). Fasten the camera with the 1/4" screw (03). Adjust the internal slide so that the lens and camera are positioned correctly.

Fasten down the adjustable slide in the correct position using the appropriate screws. When positioning the camera use also the spacers supplied for this purpose (04).

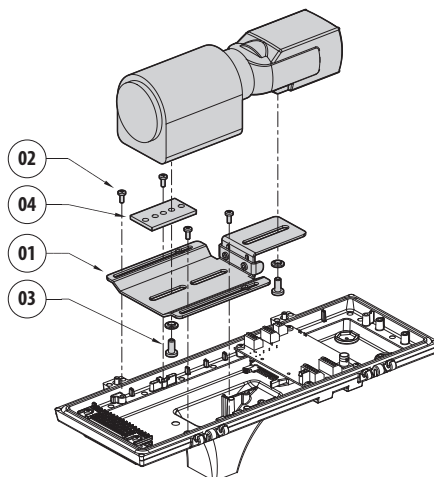

Fig. 8

Reposition the internal slide and tighten the screws that had been loosened previously.

7.7 Housing board description

BOARD DESCRIPTION	
Connector/Terminal	Function
CN1	Not used
CN2	Motorised lens motor control connector
CN3	Motorised lens potentiometer connector
CN6	Not used
CN7	Camera power supply, additional lines
DIP1	Select the lens power supply voltage

Tab. 1

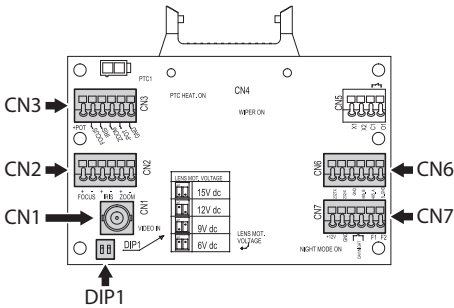

Fig. 9

7.7.1 Connection of the camera and motorised lens

⚠ All connections illustrated below should be made only and exclusively by expert installers who should comply with all the wiring and power supply specifications for the devices.

The electronics board is designed to control cameras with motorised lenses (Focus, Iris, Zoom), which may or may not have potentiometers to control the position reached.

Before making the connections make sure that the voltages supplied by the board fall within the limits allowed for the apparatus.

CONNECTOR FOR CAMERA/MOTORISED LENSES		
Voltage	Current	Description
+12V	800mA max	Camera power supply
+5V	15mA max	Lens potentiometer power supply
From 6Vdc up to 15Vdc (adjustable)	200mA max (Focus+Zoom+Iris)	Lens motor power supply

Tab. 2

Lenses with common wire motors: Implement the connections, as shown in the figure.

To power the camera perform the connections as shown in figure.

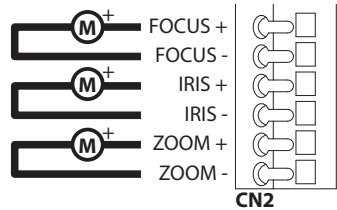

Fig. 10 CN2.

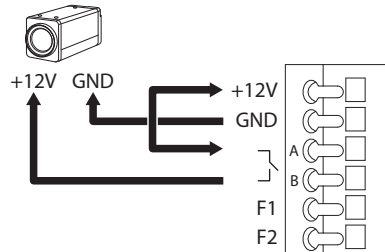

Fig. 11 CN7.

Lenses with reverse polarity motors: Implement the connections, as shown in the figure..

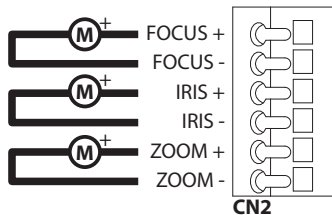

Fig. 12 CN2.

Lenses with common wire motors: Enable the relative menu option (10.1.13 Camera Parameters, page 38). Implement the connections, as shown in the figure..

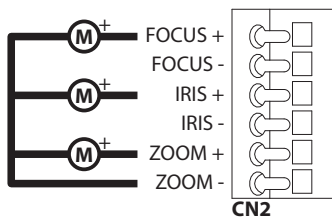

Fig. 13 CN2.

Potentiometers: Implement the connections, as shown in the figure..

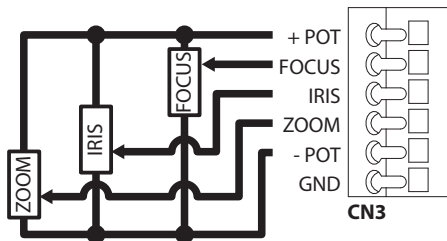

Fig. 14 CN3.

7.7.2 Adjustment of the supply voltage of the lens motors

Before powering the Pan & Tilt, select the lens power voltage using DIP1 (7.7 Housing board description, page 16).

ADJUSTMENT OF THE SUPPLY VOLTAGE OF THE LENS MOTORS		
SW1	SW2	Voltage
OFF	OFF	15Vdc
ON	OFF	12Vdc
OFF	ON	9Vdc
ON	ON	6Vdc

Tab. 3

7.7.3 Connection of the communication line

Connect the Ethernet cable to the camera.

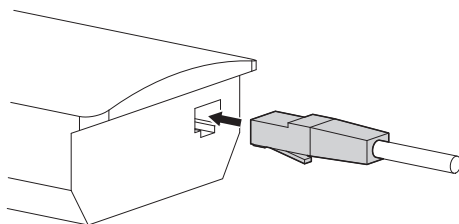

Fig. 15

i Gather the excess cable to avoid it interfering with the wiper operation (in the versions in which they are available).

8 Installation



Never, under any circumstances, make any changes or connections that are not shown in this handbook. Failure to follow the connection instructions that are given in the handbook may create serious safety hazards for people and for the installation.



Do not change the wiring in the product as it is supplied to you. Failure to follow this instruction may create serious safety hazards for people and for the installation, and will also invalidate the guarantee.



If using the washer kit, the nozzle support should be installed before positioning the pan & tilt and the wiring. For further explanations see the specific handbook for the kit.

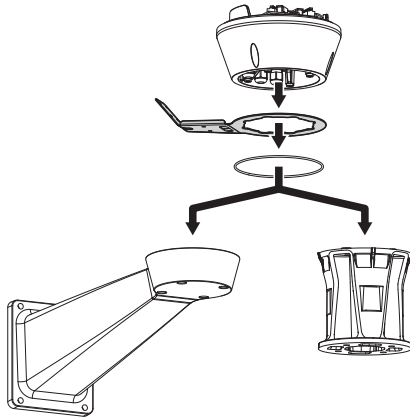

Fig. 16



Inside the bottom cover there is a desiccant bag that is used to prevent moisture formation in the base and near the connector boards. Remove the bag before installation.

8.1 Connecting the cables to the base

Insert the cables into the cable glands holding the base at about 20cm from the support. Tighten the cable glands. The cable glands are suitable for cables with a diameter between 5mm and 10 mm.

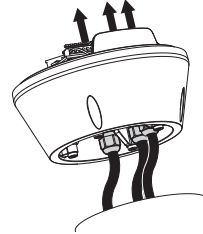

Fig. 17



Pay attention to the fixing. Tightening torque: 5Nm.



For cables diameter from 3mm to 7mm use the supplied gaskets.

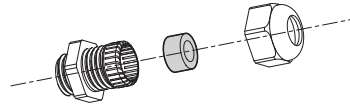

Fig. 18

8.2 Fixing the base to the support

⚠ Use the screws and the washers supplied with the base.

Once you have positioned the gasket (01), fix the base (02) onto the bracket (03) with screws (04), serrated washers (05) and screw rings (06).

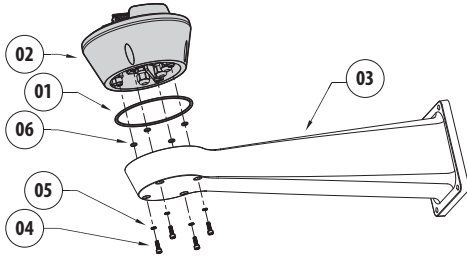

Fig. 19

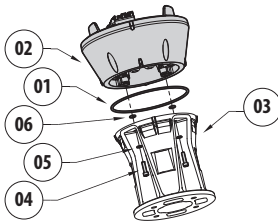

Fig. 20

Align the 3 notches on the base with those on the support as shown in the following figure.

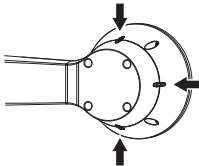

Fig. 21

⚠ Apply a thread-locker on the holes of the screws (Loctite 243®).

⚠ Pay attention to the fixing. Tightening torque: 4Nm.

8.3 Connector board description

CONNECTOR BOARD DESCRIPTION

Connector/Component	Function
CN1	Board power supply
CN4	Signal cables
Ethernet	Ethernet
F1	Fuse
F2	Fuse

Tab. 4

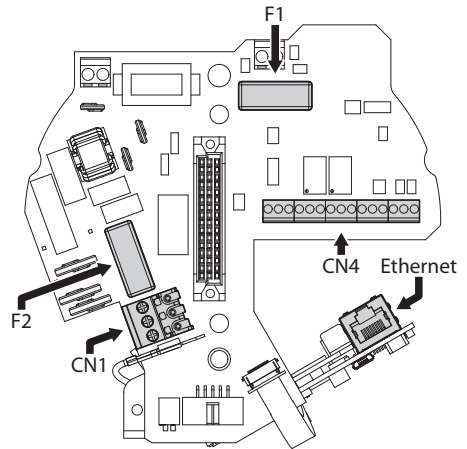

Fig. 22

8.4 Connection of the power supply line

Depending on the version, the device can be provided with different power supply voltages. Their value is shown on the product identification label (4.2 Product markings, page 10).

⚠ Electrical connections must be performed with the power supply disconnected and the circuit-breaker open.

⚠ When commencing installation make sure that the specifications for the power supply for the installation correspond with those required by the device.

⚠ Make sure that the power source and connecting cables are suitable for the power consumption of the system.

⚠ Earth cable should be about 10mm longer than the other two, so that it will not be disconnected accidentally if pulled.

⚠ The power supply cable should also be covered by the silicone sheath (01) supplied for this purpose. The silicone sheath must be fastened with the corresponding tie (02).

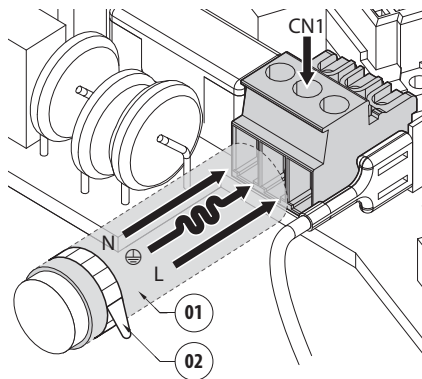

Fig. 23

8.4.1 24Vac power line connection



Use a Class 2 listed UL transformer, compliant with the Standards in force, only for products marked UL, powered at 24Vac.

Cut the cables to the correct length and make the connections. Connect the power supply to the terminal: CN1.

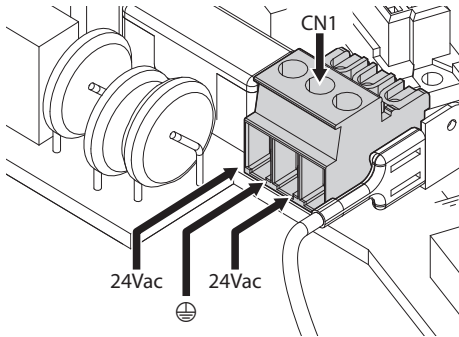

Fig. 24

Connect the power supply cables as described in the table below.

CONNECTION OF THE POWER SUPPLY LINE	
Colour	Terminals
Power supply 24Vac	
Defined by the installer	24Vac
Defined by the installer	24Vac
Yellow/Green	⊕

Tab. 5

8.4.2 120Vac and 230Vac power line connection

Cut the cables to the correct length and make the connections. Connect the power supply to the terminal: CN1.

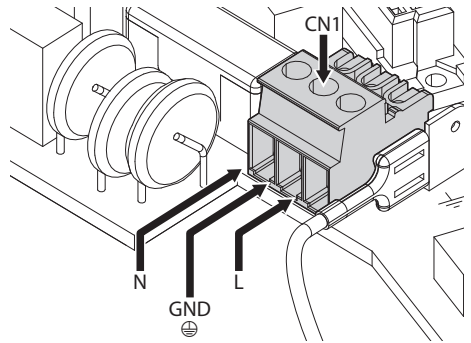

Fig. 25

Connect the power supply cables as described in the table below.

CONNECTION OF THE POWER SUPPLY LINE	
Colour	Terminals
Power supply 230Vac	
Blue	N (Neutral)
Brown	L (Phase)
Yellow/Green	⊕
Power supply 120Vac	
Blue	N (Neutral)
Brown	L (Phase)
Yellow/Green	⊕

Tab. 6

8.4.3 Connection of the alarm inputs, of the twilight switch and of the relays



CAUTION! TNV-1 installation type. The installation is type TNV-1, do not connect it to SELV circuits.



CAUTION! In order to reduce the risk of fire, only use UL Listed or CSA certified cables sizes greater than or equal to 0.13mm² (26 AWG).

Standard version

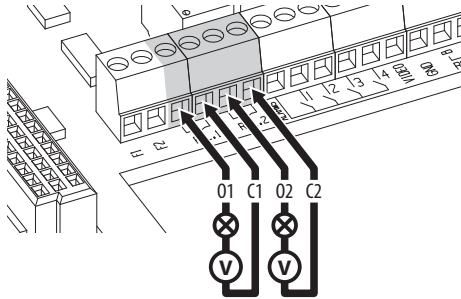

Fig. 26 Relay contact connection.

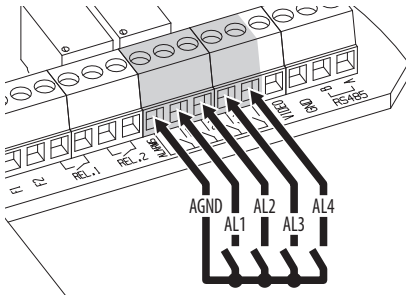

Fig. 27 Alarms connection.

Version with LED illuminators

CONNECTION OF THE ALARM INPUTS, OF THE TWILIGHT SWITCH AND OF THE RELAYS

AL1, AL2, AL3, AL4 e AGND	Self-powered alarm inputs referred to the AGND shared terminal
O1-C1 e O2-C2	Clean output contacts, can be activated by alarm or by user control

Tab. 7



Connect the twilight switch to the AGND and AL1 terminals. AL1 is the default alarm contact for the light sensitive switch.

8.5 Connection of the Ethernet cable

Connect the Ethernet cable to the connector (8.3 Connector board description, page 19).

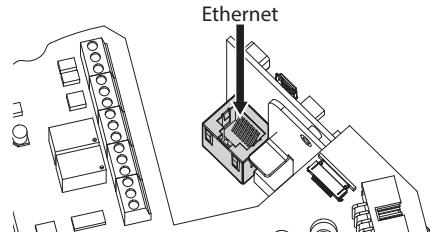

Fig. 28

8.6 Fixing the upper body

Fix the upper body (01) to the base (02) using the fixing screws (03) equipped with gaskets (04). Make sure the base seal is present and in good condition (05).

⚠ Pay attention to the fixing. Tightening torque: 4Nm.

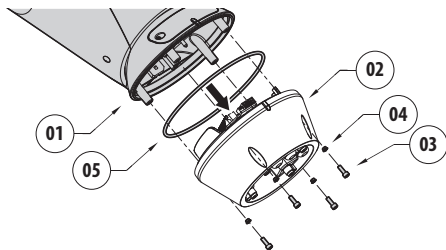

Fig. 29

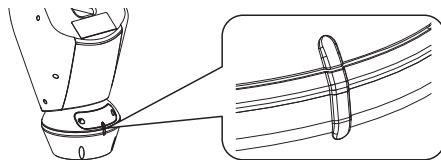

Fig. 30

i There is one anchoring position between the base and upper body. Align side projections to obtain the correct positioning.

8.7 LED illuminators installation



To work properly both illuminators must be installed together.



From Pan & Tilt, it is only possible to install VIDEOTEC illuminators.

8.7.1 Fitting the bracket

Position the bracket (01) on the bottom of the housing as shown in figure. Install the screws and the washers (02) in the holes (03) and tighten them. Make sure the bracket is fastened down firmly. Use only the material supplied with the kit.

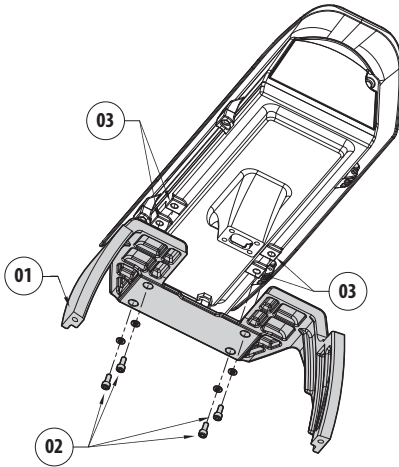

Fig. 31



Pay attention to the fixing. Tightening torque: 4Nm.

8.7.2 Fitting the illuminator on the bracket

Place the fixings of the illuminator (01) on those of the bracket (02).

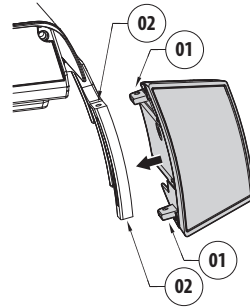

Fig. 32

Tighten the screws with the washers previously removed.

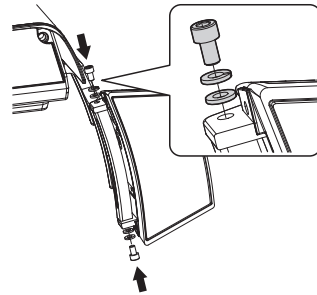

Fig. 33



Pay attention to the fixing. Tightening torque: 6Nm.

8.8 Connection of the LED illuminators

Open the housing as described (Fig. 7, page 15).
Insert the power supply cables through the cable glands by at least 25 cm.

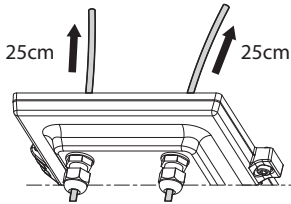
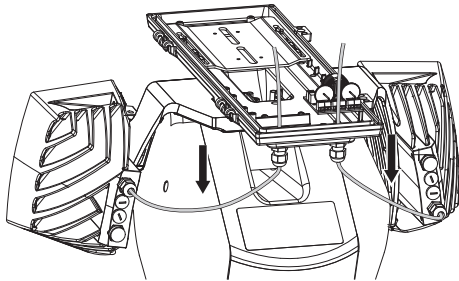

Fig. 34



To ensure the safety and the correct operation of the unit do not leave a surplus of the cable externally.



Connect the cables as shown in figure.

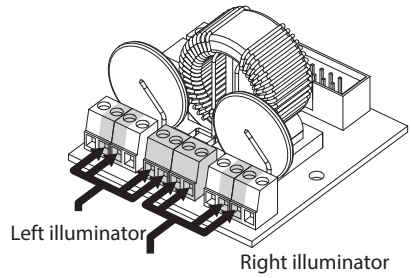

Fig. 35

CONNECTION OF THE LED ILLUMINATORS

Left illuminator		Right illuminator	
Reference on the board	Cable color	Reference on the board	Cable color
WH	White	WH	White
BK	Black	BK	Black
A1	Green	A2	Green
B1	Red	B2	Red

Tab. 8

8.9 Desiccant bag

Attach the desiccant bag using the bracket for this purpose.

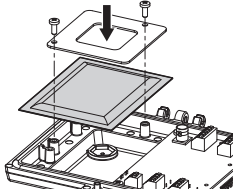

Fig. 36

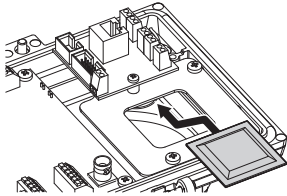

Fig. 37 Available in the versions with LED illuminators.

8.10 Setting of the LED illuminators and synchronization mode with the camera

⚠ Once the adjustment is done the illuminator on the left (MASTER) synchronizes and controls the illuminator on the right (SLAVE).

The dusk switch detects the room light and controls the activation and deactivation of the illuminators when brightness reaches the level set by the user.

When the LED illuminators are active the camera goes to night mode with the special ONVIF control.

8.10.1 Description of the LED illuminator

⚠ Do not remove the transparent screw of the twilight sensor in order not to affect the security and operation of the illuminator.

- **Twilight sensor:** Detects the light level.
- **Cable:** Power supply and control.
- **Switch-on threshold regulator:** The potentiometer allows adjusting the sensitivity threshold to switch on the illuminator.
- **Infrared power control:** The potentiometer allows adjusting the power of the illuminator.

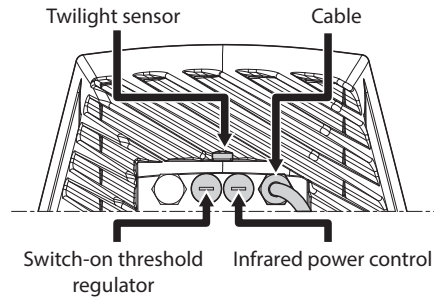

Fig. 38

8.10.2 Synchronisation with an external twilight switch

To synchronise the illuminators and camera with an external light sensitive switch you need to:

- Connect the twilight switch to the terminals: AL1/AGND (8.4.3 Connection of the alarm inputs, of the twilight switch and of the relays, page 22).
- Adjust the left illuminator (MASTER):
 - **Lighting threshold:** Set the value to OFF (8.10.5 LED illuminator switching on threshold adjustment, page 28).
 - **Infrared power:** Set the value as needed (8.10.6 LED illuminator power adjustment, page 28).
- Adjustment of the the illuminator on the right (SLAVE):
 - **Lighting threshold:** Set the value to the maximum (8.10.5 LED illuminator switching on threshold adjustment, page 28).
 - **Infrared power:** Set the value to the minimum (8.10.6 LED illuminator power adjustment, page 28).

From the IR Probe entry select the External option (10.1.13 Camera Parameters, page 38).

On the I/O digital board, set the values in the following manner: (10.1.11 Digital I/O, page 37):

- **Alarm ID:** 1
- **Type:** NORMALLY OPEN
- **Action:** IR_FILT

8.10.3 Synchronising the unit with the LED illuminators

To synchronise the unit with the LED illuminators it is necessary to:

- Adjust the left illuminator (MASTER):
 - **Lighting threshold:** Set the value as needed (8.10.5 LED illuminator switching on threshold adjustment, page 28).
 - **Infrared power:** Set the value as needed (8.10.6 LED illuminator power adjustment, page 28).

- Adjustment of the the illuminator on the right (SLAVE):
 - **Lighting threshold:** Set the value to the maximum (8.10.5 LED illuminator switching on threshold adjustment, page 28).
 - **Infrared power:** Set the value to the minimum (8.10.6 LED illuminator power adjustment, page 28).

From the Camera Parameters entry select the Internal option (10.1.13 Camera Parameters, page 38).

8.10.4 Manually activate the LED illuminators

To turn on the LED illuminators:

- Adjust the left illuminator (MASTER):
 - **Lighting threshold:** Set the value to OFF (8.10.5 LED illuminator switching on threshold adjustment, page 28).
 - **Infrared power:** Set the value as needed (8.10.6 LED illuminator power adjustment, page 28).
- Adjustment of the the illuminator on the right (SLAVE):
 - **Lighting threshold:** Set the value to the maximum (8.10.5 LED illuminator switching on threshold adjustment, page 28).
 - **Infrared power:** Set the value to the minimum (8.10.6 LED illuminator power adjustment, page 28).

8.10.5 LED illuminator switching on threshold adjustment

! The illuminator on the right must always be set to maximum brightness.

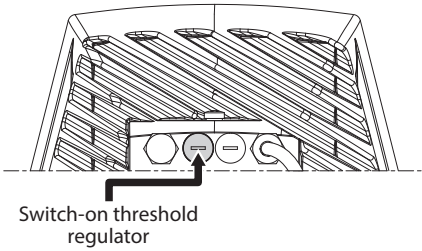

Fig. 39

The illuminator has an integrated twilight sensor that allows its automatic activation and deactivation at predefined luminous conditions.

The twilight sensor is set in the factory at a predetermined luminous level, suitable for most installations (approximately 50lx). If you want to adjust in different ways the threshold, loosen the plug on the illuminator rear and proceed for the adjustment with a screwdriver.

By rotating the trimmer clockwise, the night mode changeover is anticipated (at a greater luminous value). By rotating the trimmer anti-clockwise, the night mode changeover is delayed (at a lower luminous value).

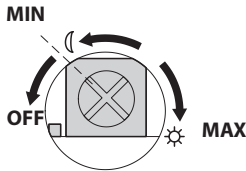

Fig. 40

Wait for appropriate brightness before switching on the illuminator. Rotate the trimmer slowly until the LED on the side of the trimmer switches on. Once the intervention threshold has been surpassed (LED on), rotate it slightly in the opposite direction.

! After making the adjustments make sure that the plug is closed tight to ensure perfect sealing.

8.10.6 LED illuminator power adjustment

! The illuminator on the right must always be set to minimum power.

i The illuminator is set in the factory to provide maximum power. If you don't need to illuminate distant subjects or if the image is over-exposed for excessive brightness, decrease the power, so that energy saving is also obtained.

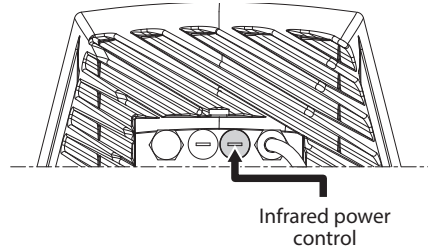

Fig. 41

Loosen the hermetic plug. Rotate the trimmer, clockwise to increase the power of the infrared illuminators and anti-clockwise to decrease it.

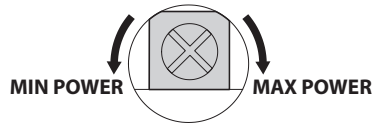

Fig. 42

! After making the adjustments make sure that the plug is closed tight to ensure perfect sealing.

8.11 Hardware configuration

i Hardware configuration is only required if you wish to activate communication via serial telemetry. (12.1 How to switch from ONVIF communication mode to RS-485 (telemetry) mode, page 42).

8.11.1 Opening the configuration door

Before powering the device it must be configured correctly by setting the dip-switches inside the configuration window. Open the hatch by undoing the screws as shown in figure.

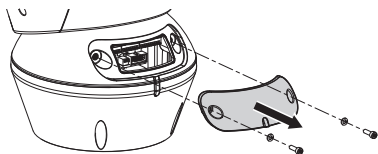

Fig. 43

The DIP-switches appear as shown in the figure.

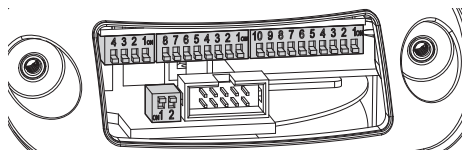

Fig. 44

i After installation and wiring, close the product again.

8.11.2 DIP1 configuration

i When the switch rocker is up it represents the value 1 (ON). When the dip-switch rocker is down it represents the value 0 (OFF).

Switch 1 is used to update the firmware.

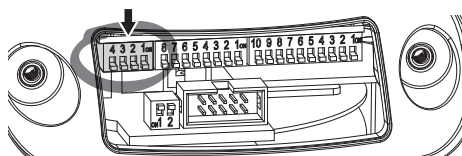

Fig. 45

DIP1 CONFIGURATION					
Description	SW 4	SW 3	SW 2	SW 1	Baud rate
Baud rate adjustment	OFF	OFF	OFF	-	300 baud
	ON	OFF	OFF	-	600 baud
	OFF	ON	OFF	-	1200 baud
	ON	ON	OFF	-	2400 baud
	OFF	OFF	ON	-	4800 baud
	ON	OFF	ON	-	9600 baud
	OFF	ON	ON	-	19200 baud
Firmware update	-	-	-	ON	Set up enabled
	-	-	-	OFF	Set up disabled

Tab. 9

8.11.3 DIP2 configuration

i When the switch rocker is up it represents the value 1 (ON). When the dip-switch rocker is down it represents the value 0 (OFF).

The Pan & Tilt can be controlled via various protocols.

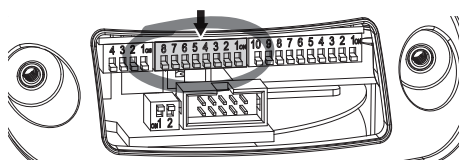

Fig. 46

DIP2 CONFIGURATION								
Protocol	SW 8	SW 7	SW 6	SW 5	SW 4	SW 3	SW 2	SW 1
PTZ Manager ¹	OFF	OFF	OFF	OFF	OFF	OFF	OFF	OFF
MACRO (VIDEOTEC)	OFF	OFF	OFF	OFF	OFF	ON	ON	ON
PANASONIC	OFF	OFF	OFF	ON	OFF	ON	OFF	OFF
PELCO D	OFF	OFF	OFF	OFF	ON	OFF	OFF	ON
AMERICAN DYNAMICS	OFF	OFF	OFF	OFF	ON	ON	ON	OFF
VISTA	OFF	OFF	OFF	ON	OFF	OFF	ON	ON

Tab. 10 ¹ Default configuration: MACRO (VIDEOTEC), 115200 baud, RS-232, Address 1. This option does not require the setting of the DIP-switch (DIP1, DIP3).

Tab. 11

8.11.4 DIP3 configuration

i When the switch rocker is up it represents the value 1 (ON). When the dip-switch rocker is down it represents the value 0 (OFF).

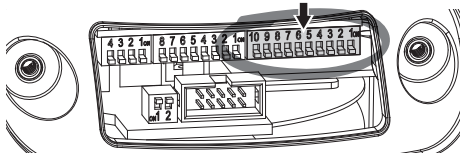

Fig. 47

8.11.4.1 Address configuration

Switches from 1 to 8 are used to configure the unit address (from 1 to 255).

Binary code is used to select the address (A Appendix - Address table, page 50).

8.11.4.2 Setting of the serial communication lines

The product includes an RS-485 communication serial line and an RS-232 serial line.

Switches 10 and 9 are used to configure the serial lines.

DIP3 CONFIGURATION

Description	SW 10	SW 9
One-way communication on RS-485-1 line Two-way communication on RS-232 line.	OFF	OFF
Two-way communication, half-duplex, on RS-485-1 line.	ON	ON

Tab. 12

8.11.5 DIP4 configuration

i This DIP is set following the inverse procedure compared to those previously performed. When the switch rocker is up it represents the value 0 (OFF). When the dip-switch rocker is down it represents the value 1 (ON).

The board has two switches used to configure the serial lines terminations (120 Ohm).

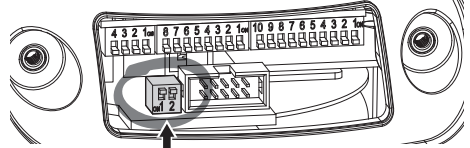

Fig. 48

Every unit that is situated at the end of a line must be terminated using the appropriate switch in order to prevent signal reflection and distortion.

DIP4 CONFIGURATION

Serial line	SW 2	SW 1	Description
Factory default	–	ON	Enabled
	–	OFF	Disabled
RS-485-1 line	ON	–	Terminated
	OFF	–	Not terminated

Tab. 13

Refer to the relative chapter to return the Pan & Tilt back to factory default (10.1.15 Factory Default, page 39).

9 Switching on



Make sure that the unit and other components of the installation are closed so that it is impossible to come into contact with live parts.



During normal operation the surface of the illuminator can reach high temperatures. Do not allow direct contact and position the appliance where it is inaccessible to unauthorised persons. Before touching switch off the illuminator and allow to cool for a minimum period of 10 minutes.



Do not stay in the vicinity of the device when it is powered. Act on the device only in the absence of a power supply.



Make sure that all parts are fastened down firmly and safely.



The automatic pre-heating (De-Ice) process could be started whenever the device is switched on and the air temperature is below 0°C. This process is used to ensure that the device works properly even at low temperatures. The duration ranges between 60 and 105 minutes, depending on conditions.

The unit is switched on by connecting the power supply.

To switch off the unit disconnect the power.

10 Configuration

10.1 Web interface

i During the first connection assign an address other than 192.168.0.100.

i Browsers supported: Microsoft Internet Explorer, Google Chrome, Mozilla Firefox.

i The MAC Address is contained on the label that is on the CPU board.

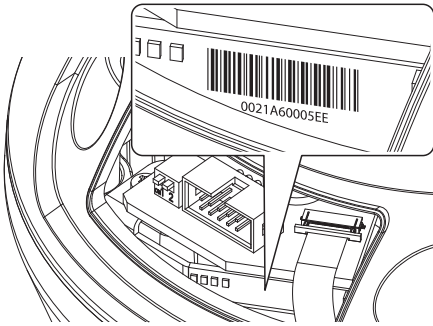

Fig. 49

The first operation in configuring the P&T unit consists in connecting to the web interface.

In the predefined settings for the configured P&T, to automatically acquire an address through a DHCP protocol, it is possible to detect the device through the ONVIF, S profile, protocol.

If no DHCP server is available, the P&T unit will configure itself automatically with the address 192.168.0.100.

If no VMS is available with the Auto Discovery functions based on ONVIF, the acquired address can be read in the DHCP server logs.

To access the Pan & Tilt web interface, simply use a browser to connect to the address `http://ip_address` and log in to Pan & Tilt using the predefined credentials:

- **Username:** admin
- **Password:** admin

10.1.1 First access

For proper operation, the pan & tilt must be configured in relation to the installed camera.

The required parameters are:

- The IP protocol used to communicate with the camera.
- The type of installed lenses (motorized, fixed or integrated).
- The credentials required to connect to the IP camera (username and password of the installed camera).

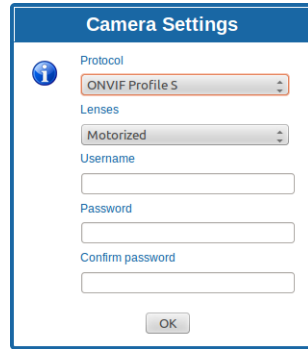

Fig. 50



The IP camera installed in Pan & Tilt must be configured to acquire the IP address using the DHCP.

10.1.2 Home

If you log in successfully, the Pan & Tilt management interface will appear.

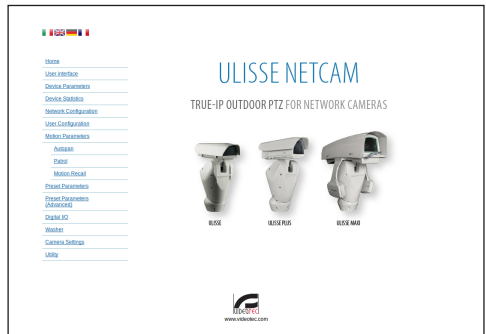

Fig. 51

10.1.3 User Controls

To control the Pan & Tilt through the browser, select the User Control entry. A new window will open with a virtual keyboard to enter commands.

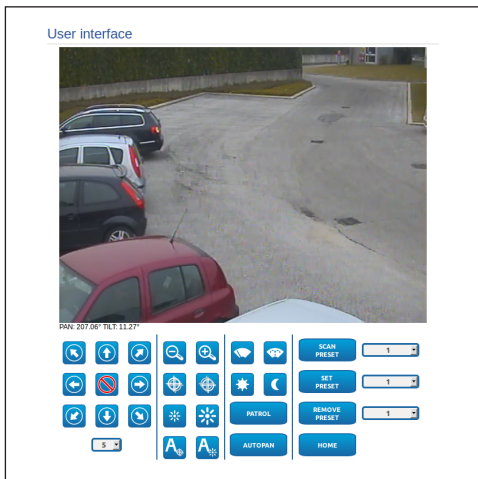

Fig. 52

The virtual keyboard contains the following controls:

- **Speed selector:** It selects the speed of the pan & tilt movements.



Fig. 53

- **Zoom wide/Zoom tele**



Fig. 54

- **Focus far/Focus near/Auto focus**



Fig. 55

- **Iris close/Iris open/Auto iris**



Fig. 56

- **Wiper/Washer**



Fig. 57

- **Day:** Activate the camera's IR filter. If available, it turns off the LED illuminators.



Fig. 58

- **Night:** Deactivate the camera's IR filter. If available, it turns on the LED illuminators.



Fig. 59

10.1.4 Device Parameters

From menu entry Device Parameters it is possible to set the name of the pan & tilt and view other additional information.

Device Parameters	
Device Name	UlisseNet.cam
Product Code	LPT2SVJANO0E
Serial Number	113121290001
MAC Address	00:21:A6:00:07:D8
Product ID	2
Firmware Version: CPU Board	2.0
Firmware Version: NET Board	6.0.0
Firmware Version: MPF Board	6.0.0
Hardware Revision	0
Major Revision	0
Minor Revision	0
Housing Type	0

Fig. 60

10.1.5 Device Statistics

From menu entry Device Statistics all of the statistics are gathered during Pan & Tilt operation are provided in read-only mode.

Device Statistics	
Pan degrees	3364
Tilt degrees	1442
Power up	133
Working hours	26
Housing max temperature (°C)	40
Housing min temperature (°C)	65.454
Pan board max temperature (°C)	50
Pan board min temperature (°C)	22
CPU board max temperature (°C)	43
CPU board min temperature (°C)	20
Net board max temperature (°C)	39
Net board min temperature (°C)	19
IR Light ON hours	0

Fig. 61

10.1.6 Network Configuration

From menu entry Network Configuration it is possible to change the setting of the Pan & Tilt network. It is possible to decide whether the device requires an address assigned statically, dynamically with DHCP or self-generated. The device supports the Internet Protocol (IP) in version 4.

i With self-generated address the device will automatically assign itself an address in the range 169.254.0.0/16.

From the same page it is possible to configure 2 DNS and decide which mechanisms must be enabled to automatically identify the devices in the local network.

Network Configuration

IP Version	IPv4
Address Type	STATIC
IP Address (IPv4)	192.168.103.121
Subnet Mask (IPv4)	255.255.255.0
Gateway (IPv4)	192.168.103.1
DNS auto discovery	DISABLED
Primary DNS	9.8.4.4
Secondary DNS	8.8.8.8
Date & Time	2013-05-27 14:41:53 UTC
NTP Server	DISABLED
PC Sync	ENABLED
UPNP	ENABLED
Zeroconf	ENABLED
Multicast discovery	ENABLED
WS discovery	ENABLED

Fig. 62

It is also possible to specify if the device needs to be synchronised with an external NTP (Network Time Protocol) server.

- **NTP -> DISABLED:** Select this option if you do not wish to synchronise date and time of the device.
- **NTP -> DHCP:** Select this option if you wish to synchronise the date and time of the device with those of an NTP server (Network Time Protocol) indicated by the DHCP server.
- **NTP -> STATIC:** Select this option if you wish to synchronise date and time of the device with those of the NTP server specified by the static address.

i For the device to operate correctly, the pan & tilt must be synchronised with the VMS software using an NTP server.

i For correct operation of the device it is necessary to synchronise the camera with the Pan & Tilt. In order to achieve this synchronisation, from the web page for the camera select option NTP from DHCP, or specify the address 192.0.0.1 as a static address of the NTP server.

10.1.7 User Configuration

From menu entry User Configuration it is possible to administer all users that have access to Pan & Tilt. Administrator type users can access the product configuration. Users such as Operators, Users and Anonymous have limited access to the management pages.

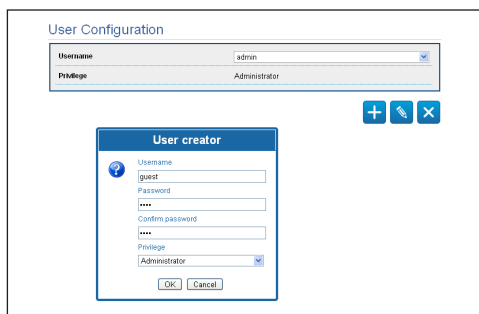

Fig. 63

i The device can be configured only by users with administration privileges.

10.1.8 Movement Parameters

From menu entry Movement Parameters it is possible to control, via web, all Pan & Tilt parameters.

- **Offset Pan:** The pan & tilt has a mechanically defined 0° position. The Offset Pan function allows the definition of a different 0° position using software.
- **Maximum Speed:** Sets the maximum manual speed.
- **Speed With Zoom:** Enables the option Speed with Zoom. When enabled, this parameter automatically slows down the Pan & Tilt speed, based on the Zoom factor.
- **Tilt Factor:** Sets the reduction factor of the tilt axis manual speed.
- **Pan Limits:** Enables the limits of Pan.
- **Pan Start:** Sets the start limit of Pan.
- **Pan End:** Sets the end limit of Pan.
- **Tilt Start:** Sets the start limit of Tilt.
- **Tilt End:** Sets the end limit of Tilt.

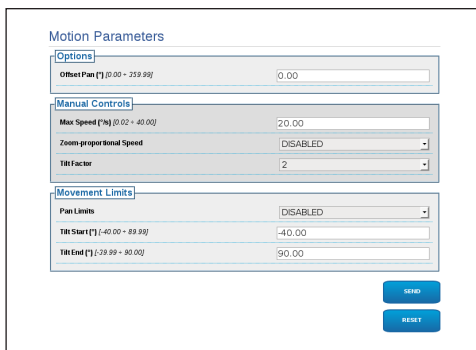

Fig. 64

10.1.8.1 Autopan

In the Autopan subsection it is possible to specify the preset autopan start and end..

Autopan

From Preset (1 = 250)	1
To Preset (2 = 250)	2

SEND
RESET

Fig. 65

10.1.8.2 Patrol

In the Patrol subsection it is possible to specify the preset patrol start and end. It is possible to specify whether the scan of the presets needs to be carried out randomly or otherwise.

Patrol

First Preset (1 = 250)	1
Last Preset (2 = 250)	250
Random Mode	DISABLED

SEND
RESET

Fig. 66

10.1.8.3 Motions Recall

In the Motion Recall subsection it is possible to specify a time interval of inactivity after which Pan & Tilt will carry out one of the following functions: return to Home position, start autopan or start patrol.

Motion Recall

Type	NONE
Timeout (20 = 240)	60

SEND
RESET

Fig. 67

10.1.9 Preset Parameters

From menu entry Preset Parameters a number of parameters relative to the presets can be configured:

- **Scan Speed:** The speed, measured in degrees to the second, at which a preset is reached by explicit operator request.
- **Ramp type:** This allows you to select the Pan & Tilt accelerations.
- **Speed Of Movements (Default):** The speed used in autopan and patrol operations.
- **Impose default speed:** The default speed will also be set as the scanning speed for all presets.
- **Default Dwell Time:** The amount of time, in seconds, it stays in each preset by default.
- **Impose default pause:** The default pause will be set for all presets.

Preset Parameters

Scan Speed (1/s) (0.02 = 40.00)	20.00
Ramp Type	1
Default Movements Speed (1/s) (0.02 = 40.00)	20.00
Set default speed value	NO
Default Dwell Time (s) (0 = 240)	5
Set default dwell time	NO

SEND
RESET

Fig. 68

10.1.10 Preset Parameters (Advanced)

In the Preset Parameters (Advanced) section it is possible to customise the speed and pause values for each preset, in addition to enabling/disabling the presets themselves.

Preset Parameters (Advanced)

Preset ID	1
Enabled	YES
Pan	0.00°
TR	0.00°
Zoom	4095
Movements Speed (0.02 = 40.00)	20.00
Dwell Time (0 = 240)	5

SEND
RESET

Fig. 69

10.1.11 Digital I/O

In the Digital I/O tab it is possible to configure the digital channels available in Pan & Tilt. What follows is a brief description of the configurable parameters for each digital input.

- **Alarm ID:** Field used to select the desired digital input.
- **Type:** It indicates the default state of the digital input. It can be set Normally Open or Normally Closed.
- **Action:** Each input can be associated with an action. The action is activated when the contact is in a state other than default. The available actions are listed below:
 - **NONE:** No action.
 - **SCAN:** Position the pan & tilt on the selected preset.
 - **PATROL:** Activate the PATROL.
 - **AUTO-PAN:** Activate AUTOPAN.
 - **WIPER:** Activate the Wiper.
 - **WASHER:** Activate the glass cleaning sequence.
 - **RELAY 1:** Activate Relay 1.
 - **RELAY 2:** Activate Relay 2.
 - **IR FILTER:** Deactivate the camera's IR Filter. If available, it turns on the LED illuminators.

To check correct operation of the alarms, a dot will appear on the web page. The dot will be green in normal conditions and red when an alarm is detected.

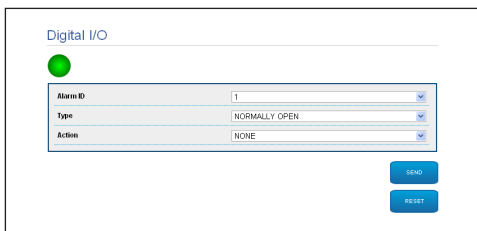

Fig. 70

10.1.12 Washer

The Pan & Tilt wash pump is configured in the Washer tab where it is possible to associate a preset to the washing operation, set the duration of washing and specify the wiper on/off delay.

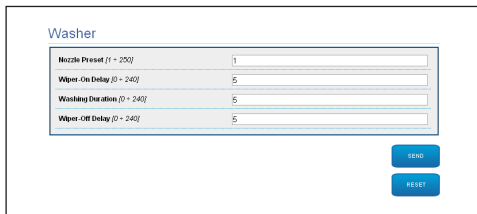

Fig. 71

10.1.13 Camera Parameters

The parameters of the IP camera that were set at first start up can be edited in the Camera Parameters section. In the Camera Parameters section it is possible to specify zoom factor and precision of the zoom position. This section also displays the data for the different ONVIF profiles exported from the camera.

From the Lenses menu item you can select one of the following options:

- **Motorized:** P&T controlled.
- **Integrated:** Camera controlled.
- **Fixed:** Not controllable.

In the case of motorized lenses it is possible to set up the connection (common wire or reverse polarity) and the rotation polarity of the zoom, the Focus and the Iris.

Camera Settings

Protocol and Authentication

Protocol	ONVIF PROFILE S
Username	admin
Password	****
Confirm password	****

Streaming Profiles

Profile ID	0
Profile	0_PROFILE_WITH_AUDIO
Codec	MPEG4
Resolution	352 x 240
Framerate limit	30 fps
Bitrate limit	512 Mbps
GOP	120 Frames
Zoom enabled	Yes

Lenses Features

Lenses	MOTORIZED
Zoom ratio (1 - 50)	15
Lenses positioning range (0 - 255)	20
Motor Type	INVERTED POLARITY
Rotation polarity of the lens Zoom	POSITIVE
Rotation polarity of the lens Focus	NEGATIVE
Rotation polarity of the lens Iris	POSITIVE
IR Probe	NONE

SEND
RESET

Fig. 72

To modify the camera settings, select the VTTunnel button (10.1.14 Tools, page 38).

10.1.14 Tools

From menu entry Tools it is possible to re-set the predefined values for the entire configuration of Pan & Tilt or only for a number of specific sections.

This section:

- Update the firmware of the device.
- Restart the pan & tilt.
- Download the VTTunnel application to enable the connection with the IP camera needed to access its web page.

Utility

- RESET PRESETS** Resets all presets settings to their factory values.
- RESET PARAMS** Resets all Motion Parameters, Digital IO settings and Washer settings to their factory values.
- RESET USERS** Resets all authentication settings to their factory values.
- RESET NETWORK** Resets all network settings to their factory values.
- RESET ALL** Resets all parameters and settings to their factory values.
- UPGRADE FIRMWARE** Upgrade device firmware.
- REBOOT DEVICE** Reboot the device.
- VTTUNNEL** Download and run VTTunnel to reach the camera directly from your browser.

Fig. 73

10.1.15 Factory Default

⚠ If the password is no longer available, you can also restore the factory settings by pressing a Reset button situated inside the base.

To restore the factory settings relative to the network, user access and camera configuration follow this procedure:

- Power the unit.
- Open the cover of the DIP-switches.
- Detect DIP switch 4 (01). Bring switch 1 down, 1 (ON) value.
- Wait for the temporary shutdown of the LEDs (02).
- Bring switch 1 up, 0 (OFF) value.
- Close the door.

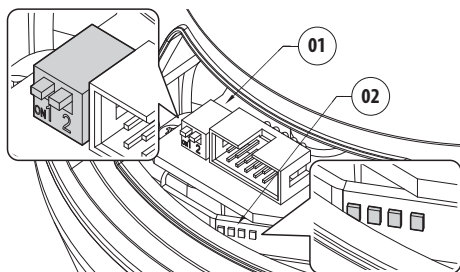

Fig. 74

10.2 VTTunnel

i The application works only with Java™. If Java™ is not installed download the latest version at www.java.com.

i The application can be connected only to the first interface of the network. Leave only the network cable connected to the pan & tilt.

i The execution of the application requires computer administrator privileges. The following message may appear on the screen: You have to execute Javaw as administrator. In this case the execution properties of the file in the Java installation folder must be modified.

In order to connect the web camera you must use the program VTTunnel, available in the Tools menu.

When the program starts, a list of networked devices will be shown. To connect to the camera select the pan & tilt desired and press the Connect key.

Once the connection is established, the web page of the IP camera can be reached at 192.0.0.64.

When the operations on the camera are done, you can close the connection by clicking the Disconnect key. It is possible to connect to one camera at a time, so you need to disconnect from the P&T unit before operating on a different unit.

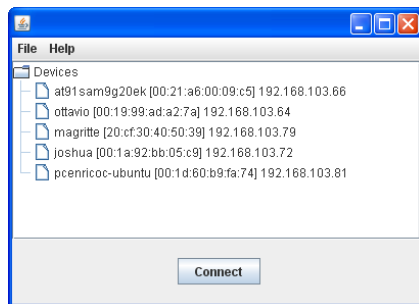

Fig. 75

i Restart the Pan & Tilt if video streaming parameters have been modified during the configuration of the camera.

11 Accessories



For further details on configuration and use, refer to the relative manual.

11.1 Washer

The P&T can be equipped with an external pump that supplies water for the glass to be cleaned.

When a control is provided, the Pan & Tilt is positioned with the window in front of the nozzle. (10.1.3 User Controls, page 33). The pump and wiper are activated for a set period of time. At the end of the operation the P&T returns to its initial position.

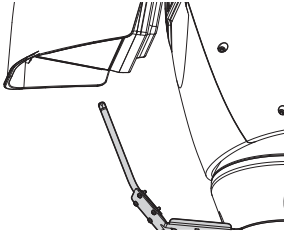

Fig. 76

11.1.1 Washing system connection



CAUTION! TNV-1 installation type. The installation is type TNV-1, do not connect it to SELV circuits.



CAUTION! In order to reduce the risk of fire, only use UL Listed or CSA certified cables sizes greater than or equal to 0.13mm^2 (26 AWG).



All signal cables must be grouped together by means of a strap.

WASHING SYSTEM CONNECTION	
Terminals	Description
O1-C1	Clean contact to activate the washing system.

Tab. 14

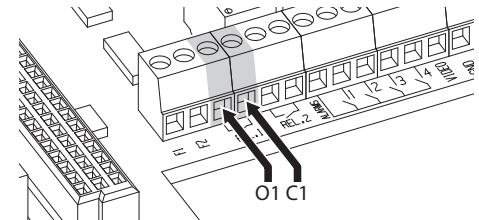

Fig. 77

11.2 Wall mount

Wall bracket with internal cable channel.

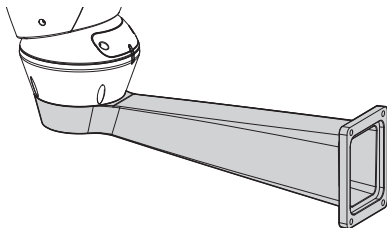

Fig. 78

11.3 Parapet bracket

Parapet bracket with internal cable channel.

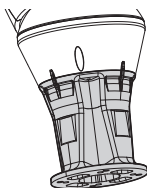

Fig. 79

11.4 Power supply with illuminator control

Weather-proof box with power supply and control of the illuminators.

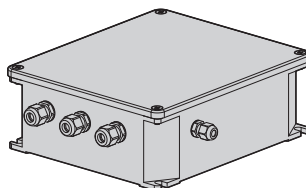

Fig. 80 Version of the standard box.

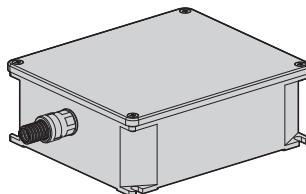

Fig. 81 Version of the UL certified box.



For further information refer to the relative chapter (8.4.3 Connection of the alarm inputs, of the twilight switch and of the relays, page 22).

12 Instructions for exceptional operation

12.1 How to switch from ONVIF communication mode to RS-485 (telemetry) mode

The P&T is by default set to communicate via ONVIF protocol.

12.1.1 How to change communication mode

Turn off the P&T.

Set the dip-switches (8.11 Hardware configuration, page 29). Follow the procedure as shown:

Baud rate: 38400 (ON ON ON OFF)

Protocol: MACRO (OFF OFF OFF OFF OFF ON ON ON)

Serial communication and telemetry address: RS-485 half-duplex, address 1 (ON ON OFF OFF OFF OFF OFF ON)

Turn on the P&T.

Set the browser address to `<ip_address>/cgi-bin/pc.cgi`.

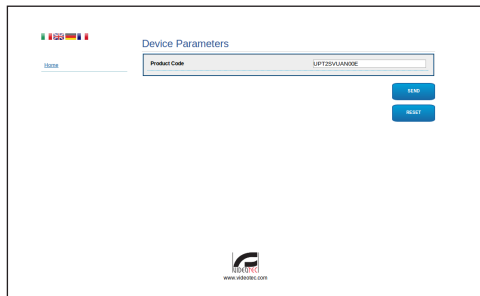

Fig. 82

Change product part number: symbol N is replaced by symbol Y. Example: From UPT2SVUAN00E to UPT2SVUAY00E.

Click Send. Allow product restart.

Set the browser address to `<ip_address>/cgi-bin/pc.cgi` to verify that the product part number was actually changed. In case of failure repeat the procedure from the beginning.

Turn off the P&T.

Switch the dip switches to OFF.

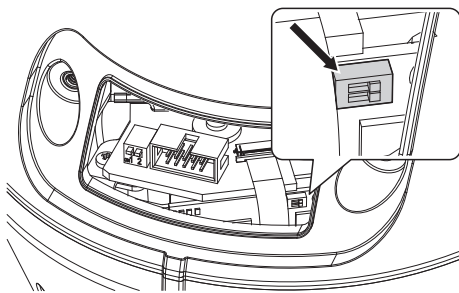

Fig. 83

Set the serial communication of the P&T as required by the camera. Set the serial communication dip switches. (8.11 Hardware configuration, page 29).

Connect the serial port of the camera to the P&T connector.

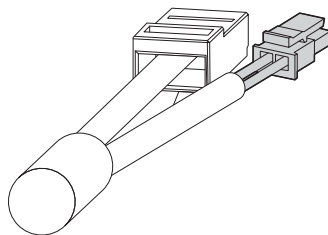

Fig. 84 Grey: RS-485 +. Pink: RS-485 -.

Power the camera.

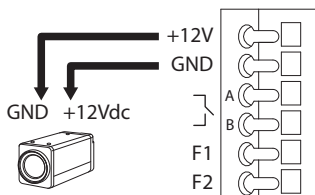



Fig. 85

Turn on the P&T.

The P&T is now configured to communicate via serial telemetry (RS-485).

13 Maintaining

 Maintenance must be carried out by personnel trained to operate on electrical circuits.

13.1 Fuses replacement

 Maintenance must be performed with the power supply disconnected and the circuit-breaker open.

If necessary, replace the fuse illustrated in figure (8.3 Connector board description, page 19).

FUSES REPLACEMENT		
Voltage	Fuse F1	Fuse F2
24Vac, 50/60Hz	F 6.3A L 250V 5x20	T 8A H 250V 5x20
120Vac, 50/60Hz	F 6.3A L 250V 5x20	T 4A H 250V 5x20
230Vac, 50/60Hz	F 6.3A L 250V 5x20	T 2A H 250V 5x20

Tab. 15

14 Cleaning

14.1 Window and plastic cover cleaning

 Avoid ethyl alcohol, solvents, hydrogenated hydrocarbide, strong acid and alkali. Such products may irreparably damage the surface.

We recommend using a soft cloth with neutral soaps diluted with water or specific products to clean the glasses lenses.

14.2 Cleaning the germanium window

 Cleaning the window take care not to scratch or damage the outer surface treated with carbon coating. Damage to this coating could also interfere with the transparency of the surface to infrared light.

Cleaning should be done with mild soap diluted with water.

15 Disposal of waste materials

 This symbol mark and recycle system are applied only to EU countries and not applied to the countries in the other area of the world.

Your product is designed and manufactured with high quality materials and components which can be recycled and reused.

This symbol means that electrical and electronic equipment, at their end-of-life, should be disposed of separately from your household waste.

Please dispose of this equipment at your local Community waste collection or Recycling centre.

In the European Union there are separate collection systems for used electrical and electronic products.

16 Troubleshooting

Ask for assistance from skilled personnel if:

- The unit is damaged after being dropped;
- There is noticeable deterioration in performance of the unit.
- The unit does not work properly, even though all the instructions in this handbook have been followed.

PROBLEM **The product does not go on.**

CAUSE *Wiring error, blown fuse.*

SOLUTION Make sure the connections are correct. Check the continuity of the fuses and replace them with the indicated models should they fail.

PROBLEM **Under special zoom conditions, the housing or sunshield interfere with the image being shot (only for versions with motorised zoom lens).**

CAUSE *The position of the camera or lens is too far back in relation to the window.*

SOLUTION Adjust the position of the camera and lens.

PROBLEM **It is not possible to connect with the camera.**

CAUSE *Incorrect camera connection.*

SOLUTION Check camera connections.

PROBLEM **During start-up the pan & tilt is disabled.**

CAUSE *Air temperature is very low.*

SOLUTION Wait until the end of the pre-heating procedure.

PROBLEM **It is not possible to control the Pan & Tilt.**

CAUSE *Incorrect communication line configuration.*

SOLUTION Check dip-switches configuration (8.11 Hardware configuration, page 29).

17 Technical data

17.1 General

- Constructed from aluminium and tecnopolymer
- Epoxy polyester powder painting, RAL9002 colour
- Top mount (OTT)
- Transmission through toothed belt
- Slip-ring
- Electronic limit switches
- Simplified installation thanks to the connector and easy replacement on-site
- Zero backlash
- Encoder for absolute positioning
- Integrated wiper
- Configuration of telemetry protocol parameters through dip-switch for RS485

17.2 Mechanical

- Cable glands: 3xM16
- Horizontal rotation: continuous
- Vertical rotation: +90° to -40°
- Horizontal speed (variable): from 0.02°/s up to 100°/s (from 0.02°/s up to 40°/s, with LED illuminators)
- Tilt speed (variable): from 0.02°/s up to 50°/s (from 0.02°/s up to 30°/s, with LED illuminators)
- Internal usable area: See drawings
- Enclosure glass window (WxH): 124x112mm (4.9x4.4in)
- Preset accuracy: 0.02°
- Unit weight: 16.8kg (37lb) (17.8kg (39.2lb), with LED illuminators bracket)

17.3 Electrical

Suitable for use with network cameras

Power supply/Current consumption:

- 230Vac, 0.4A, 50/60Hz
- 24Vac, 4A (8A with LED illuminators), 50/60Hz
- 120Vac, 0.8A, 50/60Hz

Power consumption:

- 100W
- 150-190W max with LED illuminators in 24Vac
- 28.5W, P&T stopped, heating switched off

Camera power supply: 12Vdc (800mA)

4 self-powered alarm inputs

2 dry contacts: 30Vdc max o30Vac, @ 1A

17.4 Communications

Ethernet connection: IEEE 802.3 100Base-Tx

17.5 Protocols

ONVIF, S profile

17.6 Environment

Indoor/Outdoor

Operating temperature

- With heater: -20°C (-4°F)/+60°C (140°F)
- With reinforced heater: -30°C (-22°F)/+60°C (140°F)

Surge immunity: up to 2kV line to line, up to 4kV line to earth (Class 4)

17.7 Certifications

Electrical safety (CE): EN60950-1, IEC60950-1

Electromagnetic compatibility (CE): EN50130-4, EN610000-6-4, EN55022 (Class A), FCC Part 15 (Class A)

Outdoor installation (CE): EN60950-22, IEC60950-22

Photobiological safety (CE): EN62471 LED illuminators)

IP protection degree: EN60529, IP66

Salty fog resistance: EN50130-5, EN60068-2-52

UL certification: cULus Listed (TYPE 4X)

EAC certification

18 Technical drawings

i The dimensions of the drawings are in millimetres.

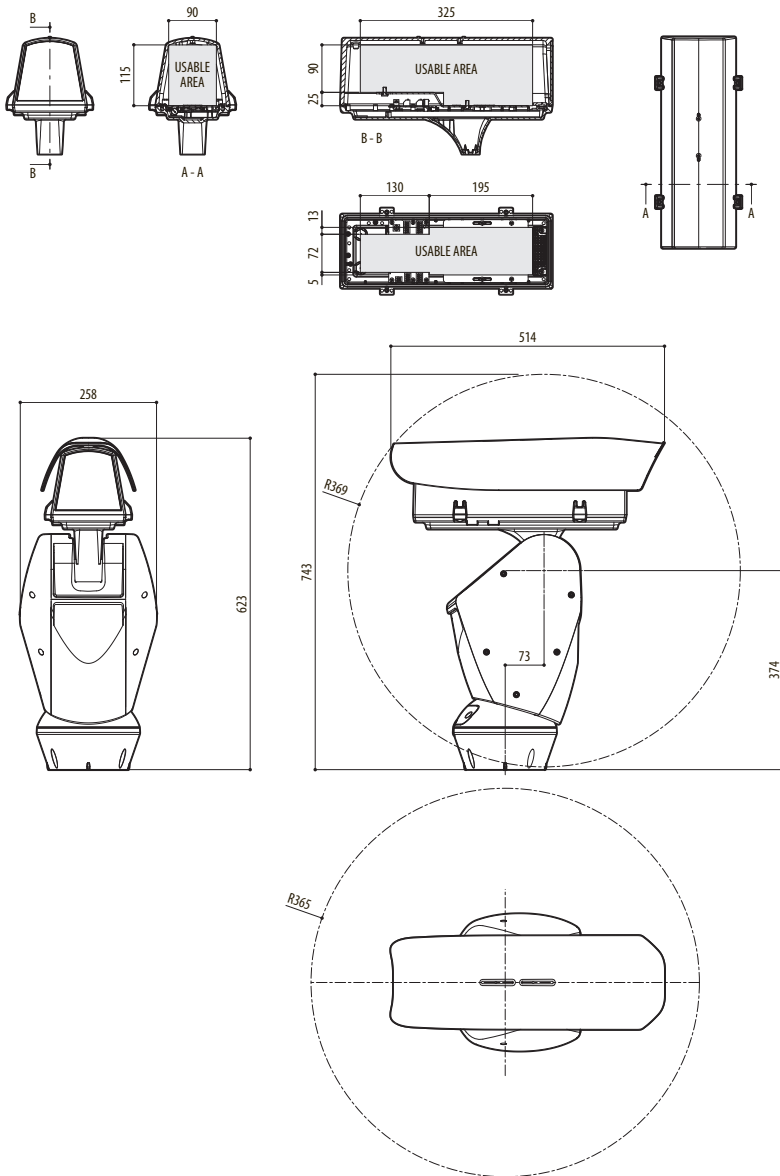

Fig. 86 ULISSE PLUS NETCAM.

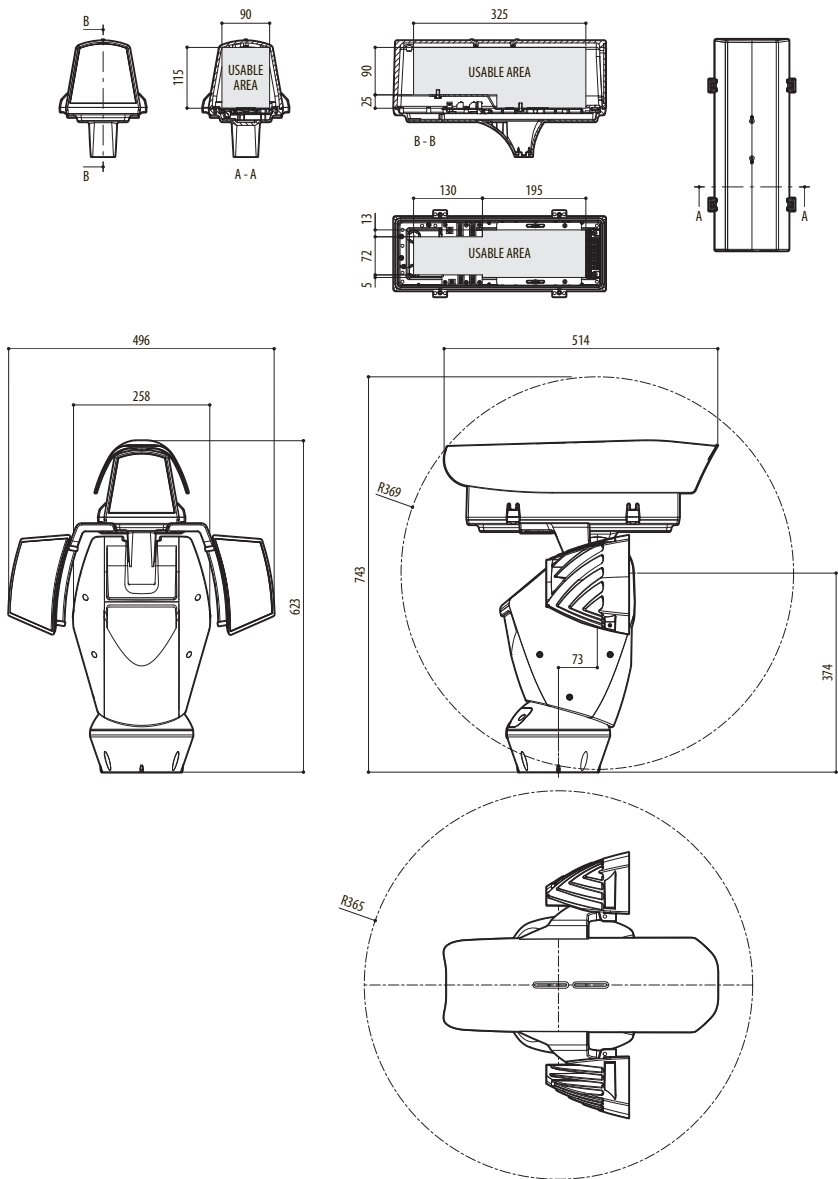

Fig. 87 ULISSE PLUS NETCAM, pre-arranged version for two LED illuminators installation.

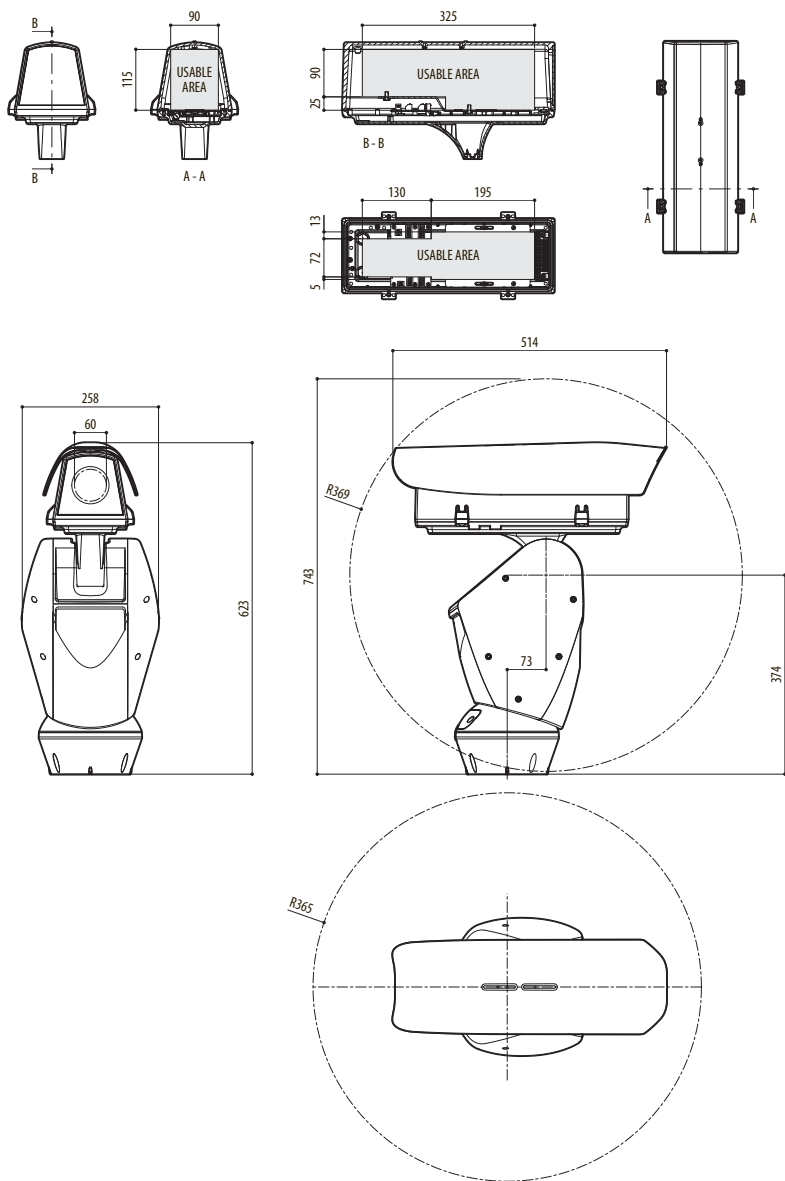

Fig. 88 ULISSE PLUS NETCAM, version for thermal cameras.

A Appendix - Address table



When the switch rocker is up it represents the value 1 (ON). When the dip-switch rocker is down it represents the value 0 (OFF).

All possible combinations are shown below.

ADDRESS CONFIGURATION (DIP 3)								
SW 8	SW 7	SW 6	SW 5	SW 4	SW 3	SW 2	SW 1	Address
OFF	OFF	OFF	OFF	OFF	OFF	OFF	OFF	Address not enabled
OFF	OFF	OFF	OFF	OFF	OFF	OFF	ON	Address 1
OFF	OFF	OFF	OFF	OFF	OFF	ON	OFF	Address 2
OFF	OFF	OFF	OFF	OFF	OFF	ON	ON	Address 3
OFF	OFF	OFF	OFF	OFF	ON	OFF	OFF	Address 4
OFF	OFF	OFF	OFF	OFF	ON	OFF	ON	Address 5
OFF	OFF	OFF	OFF	OFF	ON	ON	OFF	Address 6
OFF	OFF	OFF	OFF	OFF	ON	ON	ON	Address 7
OFF	OFF	OFF	OFF	ON	OFF	OFF	OFF	Address 8
OFF	OFF	OFF	OFF	ON	OFF	OFF	ON	Address 9
OFF	OFF	OFF	OFF	ON	OFF	ON	OFF	Address 10
OFF	OFF	OFF	OFF	ON	OFF	ON	ON	Address 11
OFF	OFF	OFF	OFF	ON	ON	OFF	OFF	Address 12
OFF	OFF	OFF	OFF	ON	ON	OFF	ON	Address 13
OFF	OFF	OFF	OFF	ON	ON	ON	OFF	Address 14
OFF	OFF	OFF	OFF	ON	ON	ON	ON	Address 15
OFF	OFF	OFF	ON	OFF	OFF	OFF	OFF	Address 16
OFF	OFF	OFF	ON	OFF	OFF	OFF	ON	Address 17
OFF	OFF	OFF	ON	OFF	OFF	ON	OFF	Address 18
OFF	OFF	OFF	ON	OFF	OFF	ON	ON	Address 19
OFF	OFF	OFF	ON	OFF	ON	OFF	OFF	Address 20
OFF	OFF	OFF	ON	OFF	ON	OFF	ON	Address 21
OFF	OFF	OFF	ON	OFF	ON	ON	OFF	Address 22
OFF	OFF	OFF	ON	OFF	ON	ON	ON	Address 23
OFF	OFF	OFF	ON	ON	OFF	OFF	OFF	Address 24
OFF	OFF	OFF	ON	ON	OFF	OFF	ON	Address 25
OFF	OFF	OFF	ON	ON	OFF	ON	OFF	Address 26
OFF	OFF	OFF	ON	ON	OFF	ON	ON	Address 27
OFF	OFF	OFF	ON	ON	ON	OFF	OFF	Address 28
OFF	OFF	OFF	ON	ON	ON	OFF	ON	Address 29
OFF	OFF	OFF	ON	ON	ON	ON	OFF	Address 30
OFF	OFF	OFF	ON	ON	ON	ON	ON	Address 31
OFF	OFF	ON	OFF	OFF	OFF	OFF	OFF	Address 32
OFF	OFF	ON	OFF	OFF	OFF	OFF	ON	Address 33
OFF	OFF	ON	OFF	OFF	OFF	ON	OFF	Address 34
OFF	OFF	ON	OFF	OFF	OFF	ON	ON	Address 35
OFF	OFF	ON	OFF	OFF	ON	OFF	OFF	Address 36
OFF	OFF	ON	OFF	OFF	ON	OFF	ON	Address 37
OFF	OFF	ON	OFF	OFF	ON	ON	OFF	Address 38

ADDRESS CONFIGURATION (DIP 3)								
SW 8	SW 7	SW 6	SW 5	SW 4	SW 3	SW 2	SW 1	Address
OFF	OFF	ON	OFF	OFF	ON	ON	ON	Address 39
OFF	OFF	ON	OFF	ON	OFF	OFF	OFF	Address 40
OFF	OFF	ON	OFF	ON	OFF	OFF	ON	Address 41
OFF	OFF	ON	OFF	ON	OFF	ON	OFF	Address 42
OFF	OFF	ON	OFF	ON	OFF	ON	ON	Address 43
OFF	OFF	ON	OFF	ON	ON	OFF	OFF	Address 44
OFF	OFF	ON	OFF	ON	ON	OFF	ON	Address 45
OFF	OFF	ON	OFF	ON	ON	ON	OFF	Address 46
OFF	OFF	ON	OFF	ON	ON	ON	ON	Address 47
OFF	OFF	ON	ON	OFF	OFF	OFF	OFF	Address 48
OFF	OFF	ON	ON	OFF	OFF	OFF	ON	Address 49
OFF	OFF	ON	ON	OFF	OFF	ON	OFF	Address 50
OFF	OFF	ON	ON	OFF	OFF	ON	ON	Address 51
OFF	OFF	ON	ON	OFF	ON	OFF	OFF	Address 52
OFF	OFF	ON	ON	OFF	ON	OFF	ON	Address 53
OFF	OFF	ON	ON	OFF	ON	ON	OFF	Address 54
OFF	OFF	ON	ON	OFF	ON	ON	ON	Address 55
OFF	OFF	ON	ON	ON	OFF	OFF	OFF	Address 56
OFF	OFF	ON	ON	ON	OFF	OFF	ON	Address 57
OFF	OFF	ON	ON	ON	OFF	ON	OFF	Address 58
OFF	OFF	ON	ON	ON	OFF	ON	ON	Address 59
OFF	OFF	ON	ON	ON	ON	OFF	OFF	Address 60
OFF	OFF	ON	ON	ON	ON	OFF	ON	Address 61
OFF	OFF	ON	ON	ON	ON	ON	OFF	Address 62
OFF	OFF	ON	ON	ON	ON	ON	ON	Address 63
OFF	ON	OFF	OFF	OFF	OFF	OFF	OFF	Address 64
OFF	ON	OFF	OFF	OFF	OFF	OFF	ON	Address 65
OFF	ON	OFF	OFF	OFF	OFF	ON	OFF	Address 66
OFF	ON	OFF	OFF	OFF	OFF	ON	ON	Address 67
OFF	ON	OFF	OFF	OFF	ON	OFF	OFF	Address 68
OFF	ON	OFF	OFF	OFF	ON	OFF	ON	Address 69
OFF	ON	OFF	OFF	OFF	ON	ON	OFF	Address 70
OFF	ON	OFF	OFF	OFF	ON	ON	ON	Address 71
OFF	ON	OFF	OFF	ON	OFF	OFF	OFF	Address 72
OFF	ON	OFF	OFF	ON	OFF	OFF	ON	Address 73
OFF	ON	OFF	OFF	ON	OFF	ON	OFF	Address 74
OFF	ON	OFF	OFF	ON	OFF	ON	ON	Address 75
OFF	ON	OFF	OFF	ON	ON	OFF	OFF	Address 76
OFF	ON	OFF	OFF	ON	ON	OFF	ON	Address 77
OFF	ON	OFF	OFF	ON	ON	ON	OFF	Address 78
OFF	ON	OFF	OFF	ON	ON	ON	ON	Address 79
OFF	ON	OFF	ON	OFF	OFF	OFF	OFF	Address 80
OFF	ON	OFF	ON	OFF	OFF	OFF	ON	Address 81
OFF	ON	OFF	ON	OFF	OFF	ON	OFF	Address 82

ADDRESS CONFIGURATION (DIP 3)

SW 8	SW 7	SW 6	SW 5	SW 4	SW 3	SW 2	SW 1	Address
OFF	ON	OFF	ON	OFF	OFF	ON	ON	Address 83
OFF	ON	OFF	ON	OFF	ON	OFF	OFF	Address 84
OFF	ON	OFF	ON	OFF	ON	OFF	ON	Address 85
OFF	ON	OFF	ON	OFF	ON	ON	OFF	Address 86
OFF	ON	OFF	ON	OFF	ON	ON	ON	Address 87
OFF	ON	OFF	ON	ON	OFF	OFF	OFF	Address 88
OFF	ON	OFF	ON	ON	OFF	OFF	ON	Address 89
OFF	ON	OFF	ON	ON	OFF	ON	OFF	Address 90
OFF	ON	OFF	ON	ON	OFF	ON	ON	Address 91
OFF	ON	OFF	ON	ON	ON	OFF	OFF	Address 92
OFF	ON	OFF	ON	ON	ON	OFF	ON	Address 93
OFF	ON	OFF	ON	ON	ON	ON	OFF	Address 94
OFF	ON	OFF	ON	ON	ON	ON	ON	Address 95
OFF	ON	ON	OFF	OFF	OFF	OFF	OFF	Address 96
OFF	ON	ON	OFF	OFF	OFF	OFF	ON	Address 97
OFF	ON	ON	OFF	OFF	OFF	ON	OFF	Address 98
OFF	ON	ON	OFF	OFF	OFF	ON	ON	Address 99
OFF	ON	ON	OFF	OFF	ON	OFF	OFF	Address 100
OFF	ON	ON	OFF	OFF	ON	OFF	ON	Address 101
OFF	ON	ON	OFF	OFF	ON	ON	OFF	Address 102
OFF	ON	ON	OFF	OFF	ON	ON	ON	Address 103
OFF	ON	ON	OFF	ON	OFF	OFF	OFF	Address 104
OFF	ON	ON	OFF	ON	OFF	OFF	ON	Address 105
OFF	ON	ON	OFF	ON	OFF	ON	OFF	Address 106
OFF	ON	ON	OFF	ON	OFF	ON	ON	Address 107
OFF	ON	ON	OFF	ON	ON	OFF	OFF	Address 108
OFF	ON	ON	OFF	ON	ON	OFF	ON	Address 109
OFF	ON	ON	OFF	ON	ON	ON	OFF	Address 110
OFF	ON	ON	OFF	ON	ON	ON	ON	Address 111
OFF	ON	ON	ON	OFF	OFF	OFF	OFF	Address 112
OFF	ON	ON	ON	OFF	OFF	OFF	ON	Address 113
OFF	ON	ON	ON	OFF	OFF	ON	OFF	Address 114
OFF	ON	ON	ON	OFF	OFF	ON	ON	Address 115
OFF	ON	ON	ON	OFF	ON	OFF	OFF	Address 116
OFF	ON	ON	ON	OFF	ON	OFF	ON	Address 117
OFF	ON	ON	ON	OFF	ON	ON	OFF	Address 118
OFF	ON	ON	ON	OFF	ON	ON	ON	Address 119
OFF	ON	ON	ON	ON	OFF	OFF	OFF	Address 120
OFF	ON	ON	ON	ON	OFF	OFF	ON	Address 121
OFF	ON	ON	ON	ON	OFF	ON	OFF	Address 122
OFF	ON	ON	ON	ON	OFF	ON	ON	Address 123
OFF	ON	ON	ON	ON	ON	OFF	OFF	Address 124
OFF	ON	ON	ON	ON	ON	OFF	ON	Address 125
OFF	ON	ON	ON	ON	ON	ON	OFF	Address 126

ADDRESS CONFIGURATION (DIP 3)								
SW 8	SW 7	SW 6	SW 5	SW 4	SW 3	SW 2	SW 1	Address
OFF	ON	ON	ON	ON	ON	ON	ON	Address 127
ON	OFF	OFF	OFF	OFF	OFF	OFF	OFF	Address 128
ON	OFF	OFF	OFF	OFF	OFF	OFF	ON	Address 129
ON	OFF	OFF	OFF	OFF	OFF	ON	OFF	Address 130
ON	OFF	OFF	OFF	OFF	OFF	ON	ON	Address 131
ON	OFF	OFF	OFF	OFF	ON	OFF	OFF	Address 132
ON	OFF	OFF	OFF	OFF	ON	OFF	ON	Address 133
ON	OFF	OFF	OFF	OFF	ON	ON	OFF	Address 134
ON	OFF	OFF	OFF	OFF	ON	ON	ON	Address 135
ON	OFF	OFF	OFF	ON	OFF	OFF	OFF	Address 136
ON	OFF	OFF	OFF	ON	OFF	OFF	ON	Address 137
ON	OFF	OFF	OFF	ON	OFF	ON	OFF	Address 138
ON	OFF	OFF	OFF	ON	OFF	ON	ON	Address 139
ON	OFF	OFF	OFF	ON	ON	OFF	OFF	Address 140
ON	OFF	OFF	OFF	ON	ON	OFF	ON	Address 141
ON	OFF	OFF	OFF	ON	ON	ON	OFF	Address 142
ON	OFF	OFF	OFF	ON	ON	ON	ON	Address 143
ON	OFF	OFF	ON	OFF	OFF	OFF	OFF	Address 144
ON	OFF	OFF	ON	OFF	OFF	OFF	ON	Address 145
ON	OFF	OFF	ON	OFF	OFF	ON	OFF	Address 146
ON	OFF	OFF	ON	OFF	OFF	ON	ON	Address 147
ON	OFF	OFF	ON	OFF	ON	OFF	OFF	Address 148
ON	OFF	OFF	ON	OFF	ON	OFF	ON	Address 149
ON	OFF	OFF	ON	OFF	ON	ON	OFF	Address 150
ON	OFF	OFF	ON	OFF	ON	ON	ON	Address 151
ON	OFF	OFF	ON	ON	OFF	OFF	OFF	Address 152
ON	OFF	OFF	ON	ON	OFF	OFF	ON	Address 153
ON	OFF	OFF	ON	ON	OFF	ON	OFF	Address 154
ON	OFF	OFF	ON	ON	OFF	ON	ON	Address 155
ON	OFF	OFF	ON	ON	ON	OFF	OFF	Address 156
ON	OFF	OFF	ON	ON	ON	OFF	ON	Address 157
ON	OFF	OFF	ON	ON	ON	ON	OFF	Address 158
ON	OFF	OFF	ON	ON	ON	ON	ON	Address 159
ON	OFF	ON	OFF	OFF	OFF	OFF	OFF	Address 160
ON	OFF	ON	OFF	OFF	OFF	OFF	ON	Address 161
ON	OFF	ON	OFF	OFF	OFF	ON	OFF	Address 162
ON	OFF	ON	OFF	OFF	OFF	ON	ON	Address 163
ON	OFF	ON	OFF	OFF	ON	OFF	OFF	Address 164
ON	OFF	ON	OFF	OFF	ON	OFF	ON	Address 165
ON	OFF	ON	OFF	OFF	ON	ON	OFF	Address 166
ON	OFF	ON	OFF	OFF	ON	ON	ON	Address 167
ON	OFF	ON	OFF	ON	OFF	OFF	OFF	Address 168
ON	OFF	ON	OFF	ON	OFF	OFF	ON	Address 169
ON	OFF	ON	OFF	ON	OFF	ON	OFF	Address 170

ADDRESS CONFIGURATION (DIP 3)

SW 8	SW 7	SW 6	SW 5	SW 4	SW 3	SW 2	SW 1	Address
ON	OFF	ON	OFF	ON	OFF	ON	ON	Address 171
ON	OFF	ON	OFF	ON	ON	OFF	OFF	Address 172
ON	OFF	ON	OFF	ON	ON	OFF	ON	Address 173
ON	OFF	ON	OFF	ON	ON	ON	OFF	Address 174
ON	OFF	ON	OFF	ON	ON	ON	ON	Address 175
ON	OFF	ON	ON	OFF	OFF	OFF	OFF	Address 176
ON	OFF	ON	ON	OFF	OFF	OFF	ON	Address 177
ON	OFF	ON	ON	OFF	OFF	ON	OFF	Address 178
ON	OFF	ON	ON	OFF	OFF	ON	ON	Address 179
ON	OFF	ON	ON	OFF	ON	OFF	OFF	Address 180
ON	OFF	ON	ON	OFF	ON	OFF	ON	Address 181
ON	OFF	ON	ON	OFF	ON	ON	OFF	Address 182
ON	OFF	ON	ON	OFF	ON	ON	ON	Address 183
ON	OFF	ON	ON	ON	OFF	OFF	OFF	Address 184
ON	OFF	ON	ON	ON	OFF	OFF	ON	Address 185
ON	OFF	ON	ON	ON	OFF	ON	OFF	Address 186
ON	OFF	ON	ON	ON	OFF	ON	ON	Address 187
ON	OFF	ON	ON	ON	ON	OFF	OFF	Address 188
ON	OFF	ON	ON	ON	ON	OFF	ON	Address 189
ON	OFF	ON	ON	ON	ON	ON	OFF	Address 190
ON	OFF	ON	ON	ON	ON	ON	ON	Address 191
ON	ON	OFF	OFF	OFF	OFF	OFF	OFF	Address 192
ON	ON	OFF	OFF	OFF	OFF	OFF	ON	Address 193
ON	ON	OFF	OFF	OFF	OFF	ON	OFF	Address 194
ON	ON	OFF	OFF	OFF	OFF	ON	ON	Address 195
ON	ON	OFF	OFF	OFF	ON	OFF	OFF	Address 196
ON	ON	OFF	OFF	OFF	ON	OFF	ON	Address 197
ON	ON	OFF	OFF	OFF	ON	ON	OFF	Address 198
ON	ON	OFF	OFF	OFF	ON	ON	ON	Address 199
ON	ON	OFF	OFF	ON	OFF	OFF	OFF	Address 200
ON	ON	OFF	OFF	ON	OFF	OFF	ON	Address 201
ON	ON	OFF	OFF	ON	OFF	ON	OFF	Address 202
ON	ON	OFF	OFF	ON	OFF	ON	ON	Address 203
ON	ON	OFF	OFF	ON	ON	OFF	OFF	Address 204
ON	ON	OFF	OFF	ON	ON	OFF	ON	Address 205
ON	ON	OFF	OFF	ON	ON	ON	OFF	Address 206
ON	ON	OFF	OFF	ON	ON	ON	ON	Address 207
ON	ON	OFF	ON	OFF	OFF	OFF	OFF	Address 208
ON	ON	OFF	ON	OFF	OFF	OFF	ON	Address 209
ON	ON	OFF	ON	OFF	OFF	ON	OFF	Address 210
ON	ON	OFF	ON	OFF	OFF	ON	ON	Address 211
ON	ON	OFF	ON	OFF	ON	OFF	OFF	Address 212
ON	ON	OFF	ON	OFF	ON	OFF	ON	Address 213
ON	ON	OFF	ON	OFF	ON	ON	OFF	Address 214

ADDRESS CONFIGURATION (DIP 3)								
SW 8	SW 7	SW 6	SW 5	SW 4	SW 3	SW 2	SW 1	Address
ON	ON	OFF	ON	OFF	ON	ON	ON	Address 215
ON	ON	OFF	ON	ON	OFF	OFF	OFF	Address 216
ON	ON	OFF	ON	ON	OFF	OFF	ON	Address 217
ON	ON	OFF	ON	ON	OFF	ON	OFF	Address 218
ON	ON	OFF	ON	ON	OFF	ON	ON	Address 219
ON	ON	OFF	ON	ON	ON	OFF	OFF	Address 220
ON	ON	OFF	ON	ON	ON	OFF	ON	Address 221
ON	ON	OFF	ON	ON	ON	ON	OFF	Address 222
ON	ON	OFF	ON	ON	ON	ON	ON	Address 223
ON	ON	ON	OFF	OFF	OFF	OFF	OFF	Address 224
ON	ON	ON	OFF	OFF	OFF	OFF	ON	Address 225
ON	ON	ON	OFF	OFF	OFF	ON	OFF	Address 226
ON	ON	ON	OFF	OFF	OFF	ON	ON	Address 227
ON	ON	ON	OFF	OFF	ON	OFF	OFF	Address 228
ON	ON	ON	OFF	OFF	ON	OFF	ON	Address 229
ON	ON	ON	OFF	OFF	ON	ON	OFF	Address 230
ON	ON	ON	OFF	OFF	ON	ON	ON	Address 231
ON	ON	ON	OFF	ON	OFF	OFF	OFF	Address 232
ON	ON	ON	OFF	ON	OFF	OFF	ON	Address 233
ON	ON	ON	OFF	ON	OFF	ON	OFF	Address 234
ON	ON	ON	OFF	ON	OFF	ON	ON	Address 235
ON	ON	ON	OFF	ON	ON	OFF	OFF	Address 236
ON	ON	ON	OFF	ON	ON	OFF	ON	Address 237
ON	ON	ON	OFF	ON	ON	ON	OFF	Address 238
ON	ON	ON	OFF	ON	ON	ON	ON	Address 239
ON	ON	ON	ON	OFF	OFF	OFF	OFF	Address 240
ON	ON	ON	ON	OFF	OFF	OFF	ON	Address 241
ON	ON	ON	ON	OFF	OFF	ON	OFF	Address 242
ON	ON	ON	ON	OFF	OFF	ON	ON	Address 243
ON	ON	ON	ON	OFF	ON	OFF	OFF	Address 244
ON	ON	ON	ON	OFF	ON	OFF	ON	Address 245
ON	ON	ON	ON	OFF	ON	ON	OFF	Address 246
ON	ON	ON	ON	OFF	ON	ON	ON	Address 247
ON	ON	ON	ON	ON	OFF	OFF	OFF	Address 248
ON	ON	ON	ON	ON	OFF	OFF	ON	Address 249
ON	ON	ON	ON	ON	OFF	ON	OFF	Address 250
ON	ON	ON	ON	ON	OFF	ON	ON	Address 251
ON	ON	ON	ON	ON	ON	OFF	OFF	Address 252
ON	ON	ON	ON	ON	ON	OFF	ON	Address 253
ON	ON	ON	ON	ON	ON	ON	OFF	Address 254
ON	ON	ON	ON	ON	ON	ON	ON	Address 255

Tab. 16

Headquarters Italy Videotec S.p.A.

Via Friuli, 6 - I-36015 Schio (VI) - Italy

Tel. +39 0445 697411 - Fax +39 0445 697414

Email: info@videotec.com

Asia Pacific Videotec (HK) Ltd

Flat 8, 19/F. On Dak Industrial Building, No. 2-6 Wah Sing Street

Kwai Chung, New Territories - Hong Kong

Tel. +852 2333 0601 - Fax +852 2311 0026

Email: info.hk@videotec.com

France Videotec France SARL

Immeuble Le Montreal, 19bis Avenue du Québec, ZA de Courtaboeuf
91140 Villebon sur Yvette - France

Tel. +33 1 60491816 - Fax +33 1 69284736

Email: info.fr@videotec.com

Americas Videotec Security, Inc.

Gateway Industrial Park, 35 Gateway Drive, Suite 100
Plattsburgh, NY 12901 - U.S.A.

Tel. +1 518 825 0020 - Fax +1 518 825 0022

Email: info.usa@videotec.com - www.videotec.us



www.videotec.com

MNVCUPTPLUS3_1511_EN



ULISSE PLUS NETCAM

**Unità PTZ Full IP da esterni per telecamere Network
con obiettivi di medie dimensioni**

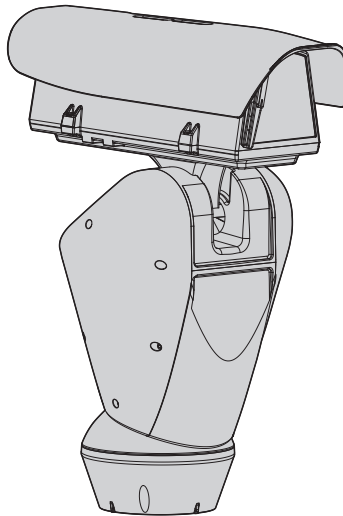

Sommario

1 Informazioni sul presente manuale	7
1.1 Convenzioni tipografiche	7
2 Note sul copyright e informazioni sui marchi commerciali.....	7
3 Norme di sicurezza	7
4 Identificazione	10
4.1 Descrizione e designazione del prodotto.....	10
4.2 Marcatura del prodotto	10
4.2.1 Controllo della marcatura.....	10
5 Versioni.....	11
5.1 Tergicristallo integrato.....	11
5.2 Illuminatori a LED.....	11
5.3 Versione con finestra in germanio.....	11
6 Preparazione del prodotto per l'utilizzo.....	12
6.1 Precauzioni di sicurezza prima dell'utilizzo.....	12
6.2 Disimballaggio.....	12
6.3 Contenuto	12
6.4 Smaltimento in sicurezza dei materiali di imballaggio.....	12
6.5 Lavoro preparatorio prima dell'installazione.....	13
6.5.1 Fissaggio del supporto	13
6.5.2 Passaggio cavi.....	13
7 Assemblaggio	14
7.6 Montaggio telecamera e ottiche motorizzate	14
7.6.1 Caratteristiche delle telecamere	14
7.6.1 Apertura della custodia.....	15
7.6.2 Installazione della telecamera	15
7.7 Descrizione della scheda della custodia.....	16
7.7.1 Collegamento della telecamera e dell'ottica motorizzata.....	16
7.7.2 Regolazione della tensione di alimentazione dei motori delle ottiche	17
7.7.3 Collegamento della linea di comunicazione	17
8 Installazione.....	18
8.1 Collegamento dei cavi alla base.....	18
8.2 Fissaggio della base al supporto.....	19
8.3 Descrizione della scheda connettori	19
8.4 Collegamento della linea di alimentazione.....	20
8.4.1 Collegamento della linea di alimentazione in 24Vac.....	21
8.4.2 Collegamento della linea di alimentazione in 120Vac e 230Vac	21
8.4.3 Collegamento degli ingressi di allarme, dell'interruttore crepuscolare e dei relè	22
8.5 Collegamento del cavo di rete Ethernet.....	22
8.6 Fissaggio del corpo superiore	23
8.7 Montaggio degli illuminatori a LED	24
8.7.1 Montaggio della staffa.....	24

8.7.2 Montaggio dell'illuminatore sulla staffa.....	24
8.8 Collegamento degli illuminatori a LED	25
8.9 Sacchetto disidratante.....	26
8.10 Regolazione degli illuminatori a LED e modalità di sincronizzazione con la telecamera	26
8.10.1 Descrizione dell'illuminatore a LED	26
8.10.2 Sincronizzazione con un interruttore crepuscolare esterno	27
8.10.3 Sincronizzare l'unità con gli illuminatori a LED	27
8.10.4 Attivazione manuale degli illuminatori a LED	27
8.10.5 Regolazione della soglia di accensione degli illuminatori a LED.....	28
8.10.6 Regolazione della potenza degli illuminatori a LED.....	28
8.11 Configurazione hardware.....	29
8.11.1 Apertura dello sportellino di configurazione	29
8.11.2 Configurazione del DIP1	29
8.11.3 Configurazione del DIP2.....	29
8.11.4 Configurazione del DIP3.....	30
8.11.4.1 Configurazione dell'indirizzo	30
8.11.4.2 Configurazione delle linee di comunicazione seriali.....	30
8.11.5 Configurazione del DIP4.....	30
9 Accensione	31
10 Configurazione	32
10.1 Interfaccia web.....	32
10.1.1 Primo accesso.....	32
10.1.2 Home	32
10.1.3 Controlli Utente	33
10.1.4 Parametri Dispositivo.....	34
10.1.5 Statistiche Dispositivo	34
10.1.6 Configurazione Rete	34
10.1.7 Configurazione Utenti.....	35
10.1.8 Parametri Movimento.....	35
10.1.8.1 Autopan.....	36
10.1.8.2 Patrol	36
10.1.8.3 Richiamo Movimenti	36
10.1.9 Parametri Preset.....	36
10.1.10 Parametri Preset (Avanzato).....	36
10.1.11 I/O Digitali	37
10.1.12 Washer	37
10.1.13 Parametri Camera	38
10.1.14 Strumenti.....	38
10.1.15 Factory Default	39
10.2 VTTunnel	39
11 Accessori.....	40
11.1 Impianto di lavaggio	40
11.1.1 Collegamento dell'impianto di lavaggio	40
11.2 Supporto da parete	41
11.3 Supporto da parapetto	41
11.4 Alimentatore con controllo degli illuminatori	41
12 Istruzioni di funzionamento eccezionale	42

12.1 Modifica della modalità di comunicazione (da protocollo ONVIF a telemetria seriale)	42
12.1.1 Procedura di modifica della modalità di comunicazione	42
13 Manutenzione	43
13.1 Sostituzione dei fusibili	43
14 Pulizia	43
14.1 Pulizia del vetro e delle parti in plastica.....	43
14.2 Pulizia della finestra in germanio	43
15 Smaltimento dei rifiuti	43
16 Risoluzione dei problemi	44
17 Dati tecnici	45
17.1 Generale	45
17.2 Meccanica	45
17.3 Elettrico.....	46
17.4 Comunicazioni	46
17.5 Protocolli	46
17.6 Ambiente.....	46
17.7 Certificazioni	46
18 Disegni tecnici	47
A Appendice - Tabella degli indirizzi.....	50

1 Informazioni sul presente manuale

Prima di installare e utilizzare questa unità, leggere attentamente questo manuale. Conservare questo manuale a portata di mano come riferimento futuro.

1.1 Convenzioni tipografiche



PERICOLO!
Pericolosità elevata.
Rischio di scosse elettriche. Prima di eseguire qualsiasi operazione assicurarsi di togliere tensione al prodotto, salvo diversa indicazione.



PERICOLO!
Superficie calda.
Evitare il contatto. Le superfici sono calde e potrebbero causare danni alla persona in caso di contatto.



PERICOLO!
Pericolo di natura meccanica.
Rischio di schiacciamento o cesoiamento.



ATTENZIONE!
Pericolosità media.
L'operazione è molto importante per il corretto funzionamento del sistema. Si prega di leggere attentamente la procedura indicata e di eseguirla secondo le modalità previste.



INFO
Descrizione delle caratteristiche del sistema.
Si consiglia di leggere attentamente per comprendere le fasi successive.

2 Note sul copyright e informazioni sui marchi commerciali

I nomi di prodotto o di aziende citati sono marchi commerciali o marchi commerciali registrati appartenenti alle rispettive società.

3 Norme di sicurezza



ATTENZIONE! L'impianto elettrico al quale è collegata l'unità deve essere dotato di un interruttore di protezione bipolare automatico da 20A max. Tale interruttore deve essere di tipo Listed. La distanza minima tra i contatti deve essere di 3mm. L'interruttore deve essere provvisto di protezione contro la corrente di guasto verso terra (differenziale) e la sovracorrente (magnetotermico).



ATTENZIONE! Parti mobili pericolose. Non avvicinare dita e altre parti del corpo.



ATTENZIONE! L'installazione e la manutenzione del dispositivo deve essere eseguita solo da personale tecnico qualificato.



ATTENZIONE! Per assicurare la protezione contro il rischio di incendio, sostituire i fusibili con lo stesso tipo e valore. I fusibili devono essere sostituiti solo da personale qualificato.



ATTENZIONE! L'installazione è di tipo TNV-1. Non collegare a circuiti SELV.



ATTENZIONE! Per ridurre il rischio di incendio usare solamente cavi certificati UL Listed o CSA aventi dimensioni maggiori o uguali a 0.13mm² (26 AWG).

- Il produttore declina ogni responsabilità per eventuali danni derivanti da un uso improprio delle apparecchiature menzionate in questo manuale. Si riserva inoltre il diritto di modificarne il contenuto senza preavviso. Ogni cura è stata posta nella raccolta e nella verifica della documentazione contenuta in questo manuale. Il produttore, tuttavia, non può assumersi alcuna responsabilità derivante dall'utilizzo della stessa. Lo stesso dicasi per ogni persona o società coinvolta nella creazione e nella produzione di questo manuale.

- Prima di eseguire qualsiasi operazione assicurarsi di togliere tensione al prodotto.
- Non utilizzare cavi con segni di usura o invecchiamento.
- Non effettuare per nessun motivo alterazioni o collegamenti non previsti in questo manuale. L'uso di apparecchi non idonei può portare a gravi pericoli per la sicurezza del personale e dell'impianto.
- Utilizzare solo parti di ricambio originali. Pezzi di ricambio non originali potrebbero causare incendi, scariche elettriche o altri pericoli.
- Prima di procedere con l'installazione, controllare che il materiale fornito corrisponda alle specifiche richieste esaminando le etichette di marcatura (4.2 Marcatura del prodotto, pagina 10).
- Questo dispositivo è stato progettato per essere installato in maniera permanente su un edificio o su una struttura adeguata. Il dispositivo deve essere installato in maniera permanente prima di effettuare qualsiasi operazione.
- La categoria di installazione (detta anche categoria di sovratensione) specifica i livelli della tensione transitoria di rete alla quale l'apparato è soggetto. La categoria dipende dal luogo di installazione e dalla presenza di dispositivi di protezione contro le sovratensioni. Un dispositivo per ambienti industriali, connesso ai rami principali dell'impianto di alimentazione è soggetto alla categoria di installazione III. Se questo è il caso, è richiesta una riduzione alla categoria II. Ciò può essere ottenuto utilizzando un trasformatore di isolamento con schermatura connessa a terra tra il primario ed il secondario, o tramite l'impiego di dispositivi di protezione contro le sovratensioni (SPD), UL listed, connessi tra la fase ed il neutro a tra il neutro e terra. I dispositivi SPD UL listed, dovranno essere predisposti per limitare sovratensioni transitorie in modo ripetitivo e per la seguenti condizioni nominali di funzionamento: Tipo 2 (Dispositivi SPD connessi permanentemente alla rete di alimentazione, per installazioni dal lato del carico del dispositivo di servizio); Corrente nominale di scarica (In) 20kA minimi. Si possono utilizzare ad esempio: FERRAZ SHAWMUT, ST23401PG-CN, ST240SPG-CN specificati per 120Vac/240Vac, (In=20kA). La distanza massima tra l'installazione e la riduzione è di 5m.
- Per i prodotti marcati UL alimentati a 24Vac, utilizzare un trasformatore UL listed Classe 2, conforme alle normative vigenti.
- Un dispositivo di scollegamento, prontamente e facilmente accessibile, deve essere incorporato nell'impianto elettrico dell'edificio per un intervento rapido.
- Il terminale di terra disponibile nel prodotto deve essere collegato permanentemente alla terra.
- Collegare il dispositivo ad una sorgente d'alimentazione corrispondente a quella indicata nell'etichetta di marcatura. Prima di procedere con l'installazione verificare che la linea elettrica sia opportunamente sezionata. La tensione di alimentazione non deve eccedere i limiti ($\pm 10\%$).
- L'alimentazione deve essere fornita da una sorgente isolata di tipo SELV, 24Vac, 8A derivata da un trasformatore a doppio isolamento UL Listed, opportunamente protetto in uscita.
- Il dispositivo va montato in modo da non essere accessibile al personale diverso dal tecnico/ installatore in quanto, essendo dotato di parti mobili, rimane residuo il pericolo di ferirsi a seguito dei movimenti delle parti mobili.
- Applicare l'etichetta Parti Mobili Pericolose vicino all'unità (Fig. 5, pagina 12).
- Non utilizzare l'apparecchio in presenza di sostanze infiammabili.
- Per la connessione della linea di alimentazione utilizzare l'apposita scatola di connessione (UPTJ BUL). Per ulteriori informazioni fare riferimento al manuale d'uso ed installazione del prodotto.

- Non permettere l'uso dell'apparecchio a bambini o personale non autorizzato.
- L'apparecchio si considera disattivato soltanto quando l'alimentazione è stata tolta e i cavi di collegamento con altri dispositivi sono stati rimossi.
- La manutenzione del dispositivo deve essere eseguita solo da personale qualificato. Durante le operazioni di manutenzione l'operatore è esposto al rischio di folgorazione o ad altri pericoli.
- Utilizzare solo gli accessori indicati dal costruttore. Qualsiasi cambiamento non espressamente approvato dal costruttore fa decadere la garanzia.
- Prima di collegare tutti i cavi di segnale verificare che l'unità sia opportunamente collegata al circuito di terra.
- Se il dispositivo deve essere rimosso dall'impianto, scollegare sempre per ultimo il cavo di terra.
- Adottare le dovute precauzioni per evitare di danneggiare l'apparecchiatura con scariche elettrostatiche.
- L'unità è stata realizzata per essere collegata con cavo tripolare. Seguire le indicazioni per un corretto collegamento del circuito di terra descritte nel presente manuale.
- Maneggiare con cura l'unità, forti sollecitazioni meccaniche potrebbero danneggiarla.
- Porre particolare attenzione alle distanze di isolamento tra la linea di alimentazione e tutti gli altri cavi compresi i dispositivi di protezione contro i fulmini.
- È possibile trasportare il dispositivo solo prestando la massima attenzione. Fermate brusche, dislivelli e impatti violenti possono causare danneggiamenti all'oggetto o ferite per l'utente.

4 Identificazione

4.1 Descrizione e designazione del prodotto

ULISSE PLUS NETCAM è un potente PTZ Full-IP per applicazioni in esterno di videosorveglianza IP, in grado di gestire le moderne telecamere IP SD, HD e Megapixel, integrandosi in un sistema network.

Questo modello può contenere telecamere con obiettivi di medie dimensioni permettendo il monitoraggio dinamico e non-stop di ampie aree esterne a 360°.

La particolarità di ULISSE PLUS NETCAM è la possibilità di controllare facilmente tramite rete tutte le funzioni della telecamera e del brandeggio, inclusi tergicristallo, preset e set-up, utilizzando i più diffusi VMS sul mercato. È possibile utilizzare qualsiasi telecamera compatibile ONVIF profilo S, oppure protocollo proprietario su RS-485, mentre l'intera gestione del sistema necessita unicamente di un indirizzo IP.

L'unità è dotata di tergicristallo per pulizia del vetro frontale da pioggia e polvere; è disponibile una vasta scelta di taniche con pompa lavavetro con diverse capacità e prevalenze.

Per garantire immagini dettagliate anche durante le ore notturne, sono disponibili versioni con illuminatori a LED, con luce ad infrarosso o luce bianca.

L'accurata costruzione top-mount permette la visione oltre l'orizzonte e la rotazione continua sull'asse orizzontale e unisce alta velocità ad un'assoluta precisione di puntamento, sia in manuale che in funzione di ronda.

L'unità è provvista di sensori ottici che garantiscono il preciso controllo della posizione in qualsiasi condizione di utilizzo.

4.2 Marcatura del prodotto

i Sui brandeggi è applicata una etichetta conforme alla marcatura CE.

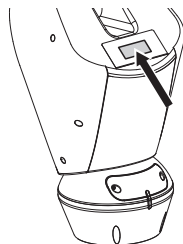

Fig. 1

L'etichetta riporta:

- Codice di identificazione del modello (Codice a barre Extended 3/9).
- Tensione di alimentazione (Volt).
- Frequenza (Hertz).
- Corrente assorbita (Ampere).
- Grado di protezione (IP).
- Numero di serie.

4.2.1 Controllo della marcatura

Prima di procedere con l'installazione controllare che il materiale fornito corrisponda alle specifiche richieste, esaminando le etichette di marcatura.

Non effettuare per nessun motivo alterazioni o collegamenti non previsti in questo manuale. L'uso di apparecchi non idonei può portare a gravi pericoli per la sicurezza del personale e dell'impianto.

5 Versioni

5.1 Tergicristallo integrato

Il prodotto può essere provvisto di tergicristallo.

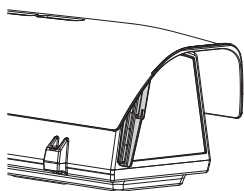

Fig. 2

i Per ulteriori informazioni fare riferimento al relativo capitolo (10.1.3 Controlli Utente, pagina 33).

Il brandeggio può essere dotato di una pompa esterna che fornisce acqua per la pulizia del vetro.

i Per ulteriori informazioni fare riferimento al relativo capitolo (11.1 Impianto di lavaggio, pagina 40).

5.2 Illuminatori a LED

! La versione con illuminatori a LED è alimentabile solamente in 24Vac.

Il brandeggio può essere dotato di un supporto per montaggio di 2 illuminatori a LED VIDEOTEC per la visione notturna (illuminatori non inclusi).

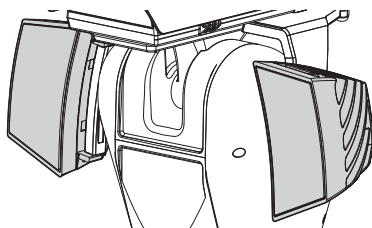

Fig. 3

i Per ulteriori informazioni fare riferimento al relativo capitolo (8.7 Montaggio degli illuminatori a LED, pagina 24).

5.3 Versione con finestra in germanio

La versione con finestra in germanio è stata studiata per applicazioni con telecamere termiche.

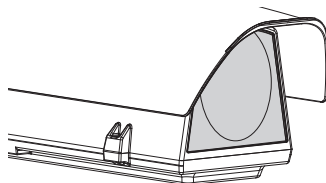

Fig. 4

6 Preparazione del prodotto per l'utilizzo

! **Qualsiasi cambiamento non espressamente approvato dal costruttore fa decadere la garanzia.**

! **L'unità non deve essere smontata o manomessa. Le uniche eccezioni sono quelle che riguardano le operazioni di montaggio e manutenzione previste nel presente manuale.**

6.1 Precauzioni di sicurezza prima dell'utilizzo

! **L'apparecchiatura comprende parti mobili. Assicurarsi che l'unità venga posizionata in un'area non accessibile durante le normali condizioni di funzionamento. Applicare l'apposita etichetta fornita assieme all'apparecchio nelle sue vicinanze ed in modo ben visibile.**



Fig. 5

6.2 Disimballaggio

Alla consegna del prodotto verificare che l'imballo sia integro e non abbia segni evidenti di cadute o abrasioni.

In caso di evidenti segni di danno all'imballo contattare immediatamente il fornitore.

Conservare l'imballo nel caso sia necessario inviare il prodotto in riparazione.

i **Disimballare il tettuccio del dispositivo avendo cura di non danneggiare la custodia.**

6.3 Contenuto

Controllare che il contenuto sia corrispondente alla lista del materiale sotto elencata:

- Unità di posizionamento
- Base di alimentazione
- Imballo degli accessori:
 - Adattatore seriale
 - Cavo prolunga seriale
 - Chiavi a brugola
 - Distanziali (non presenti nella versione con telecamera integrata)
 - Etichetta
 - Fascette
 - Guaina siliconica
 - Guarnizioni di riduzione per pressacavi
 - Manuale di istruzioni
 - Piastra di fissaggio per sacchetto disidratante (non presente nelle versioni con illuminatori a LED)
 - Sacchetto disidratante
 - Viteria
- Staffa per fissaggio illuminatori a LED (presente nelle versioni con illuminatori a LED)
- Tettuccio

6.4 Smaltimento in sicurezza dei materiali di imballaggio

I materiali d'imballo sono costituiti interamente da materiale riciclabile. Sarà cura del tecnico installatore smaltirli secondo le modalità di raccolta differenziata o comunque secondo le norme vigenti nel Paese di utilizzo.

In caso di restituzione del prodotto malfunzionante è consigliato l'utilizzo dell'imballaggio originale per il trasporto.

6.5 Lavoro preparatorio prima dell'installazione

6.5.1 Fissaggio del supporto

Sono disponibili diversi tipi di supporto (11 Accessori, pagina 40). Scegliere il supporto adeguato all'installazione e seguire tutte le istruzioni nel capitolo indicato.

⚠ **Porre particolare attenzione ai sistemi di fissaggio dell'apparecchiatura. Il sistema di fissaggio deve essere in grado di reggere almeno 4 volte il peso dell'intera apparecchiatura, comprensiva di brandeggio, lenti e telecamera.**

⚠ **Il dispositivo deve essere montato in posizione verticale. Ogni posizionamento alternativo potrebbe compromettere le prestazioni dell'apparecchiatura.**

⚠ **Non montare il dispositivo capovolto.**

6.5.2 Passaggio cavi

⚠ **I cavi di collegamento non devono essere accessibili dall'esterno. I cavi devono essere opportunamente fissati al sostegno per evitare che l'eccessivo peso ne comporti lo sfilamento accidentale.**

⚠ **I cavi utilizzati devono essere conformi al tipo di installazione.**

Introdurre i cavi all'interno del supporto in modo che fuoriescano per circa 50cm.

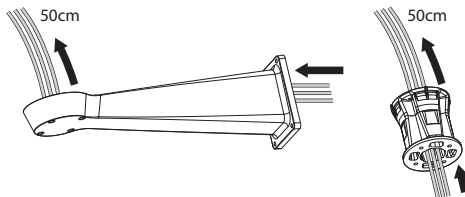

Fig. 6

7 Assemblaggio



Possono essere installate solamente telecamere di rete con determinate caratteristiche tecniche (7.6.1 Caratteristiche delle telecamere, pagina 14).

7.6 Montaggio telecamera e ottiche motorizzate



Il corretto funzionamento dell'apparecchiatura, nel range di temperatura indicato, é garantito solo se si utilizzano telecamera ed ottica con limiti di temperatura pari ad almeno -10°C e + 60°C.

Il montaggio della telecamera e dei relativi obiettivi è a cura del cliente.

7.6.1 Caratteristiche delle telecamere



Il corretto funzionamento dell'apparecchiatura, nel range di temperatura indicato, é garantito solo se si utilizzano telecamera ed ottica con limiti di temperatura pari ad almeno -10°C e + 60°C.



La telecamera deve essere pre-configurata per acquisire l'indirizzo IP mediante DHCP.



La telecamera deve essere pre-configurata per interfacciarsi al server NTP mediante DHCP. Se la configurazione NTP mediante DHCP non è possibile, impostare il seguente indirizzo statico del server NTP: 192.0.0.1.



Nell'unità possono essere installate solamente telecamere di rete.

- Si possono montare solo telecamere con porta di comunicazione Ethernet di tipo 100 baseTx.
- Si possono montare solo telecamere munite di morsetto di alimentazione. Il brandeggio non è in grado di fornire alimentazione direttamente sul cavo Ethernet (Power over Ethernet).
- La tensione di alimentazione dalla telecamera deve essere 12Vdc.
- La corrente massima assorbita dalla telecamera deve essere inferiore a 800mA.
- Il protocollo di comunicazione deve essere ONVIF, profilo S. La telecamera deve essere pre-configurata per comunicare tramite il protocollo ONVIF, profilo S.
- La telecamera deve essere in grado di funzionare correttamente tra -10°C e +60°C.

7.6.1 Apertura della custodia

Per l'apertura della custodia, svitare le viti poste sui fianchi e sollevare il corpo superiore.

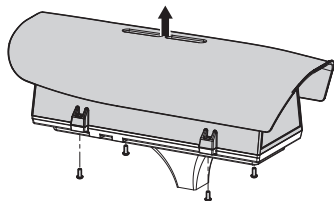

Fig. 7



Una volta rimossa la parte superiore della custodia accompagnarla fino a che il cavo di ancoraggio sia teso. Non lasciar cadere la parte superiore della custodia, il peso potrebbe spezzare il cavo.



Al termine delle operazioni di installazione e cablaggio richiudere il prodotto.

7.6.2 Installazione della telecamera

Estrarre la slitta interna d'appoggio (01) svitando le viti di fissaggio (02). Fissare la telecamera con la vite da 1/4" (03). Regolare la slitta interna per posizionare correttamente ottica e telecamera.

Fissare la slitta regolabile nella posizione corretta con le apposite viti. Per il posizionamento della telecamera possono essere utilizzati anche i distanziali forniti in dotazione (04).

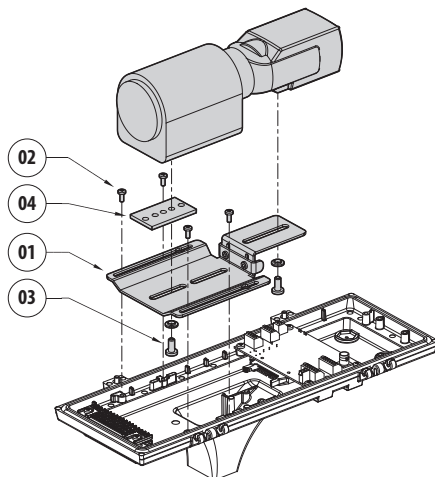

Fig. 8

Riposizionare la slitta interna serrando le viti precedentemente allentate.

7.7 Descrizione della scheda della custodia

DESCRIZIONE DELLA SCHEDA	
Connettore/Morsetto	Funzione
CN1	Non utilizzato
CN2	Connettore controllo motori ottiche motorizzate
CN3	Connettore potenziometri ottiche motorizzate
CN6	Non utilizzato
CN7	Alimentazione telecamera, linee addizionali
DIP1	Selezione della tensione di alimentazione delle ottiche

Tab. 1

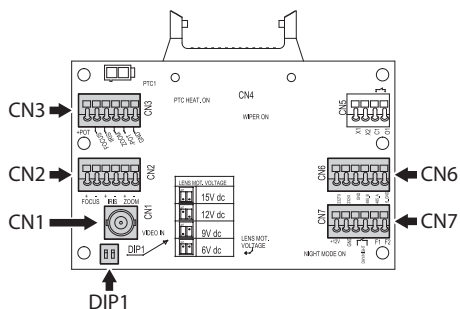

Fig. 9

7.7.1 Collegamento della telecamera e dell'ottica motorizzata

⚠ Tutti i collegamenti illustrati di seguito devono essere eseguiti solo da installatori esperti e devono essere rispettate tutte le specifiche di cablaggio e di alimentazione dei dispositivi.

La scheda elettronica è predisposta per poter controllare telecamere con ottiche motorizzate (Focus, Iris, Zoom), dotate o meno di potenziometri per il controllo della posizione raggiunta.

Prima di procedere ai collegamenti, verificare che le tensioni fornite dalla scheda rientrino nei limiti previsti per l'apparecchiatura.

CONNETTORE DELLA TELECAMERA CON OTTICHE MOTORIZZATE		
Tensione	Corrente	Descrizione
+12V	800mA max	Alimentazione telecamera
+5V	15mA max	Alimentazione potenziometri ottiche
Da 6Vdc fino a 15Vdc (regolabile)	200mA max (Focus+Zoom+Iris)	Alimentazione motori ottiche

Tab. 2

Ottiche con motori a filo comune: Eseguire le connessioni come illustrato in figura.

Per l'alimentazione della telecamera effettuare i collegamenti come illustrato in figura.

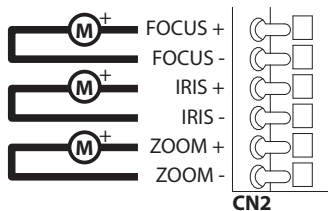

Fig. 10 CN2.

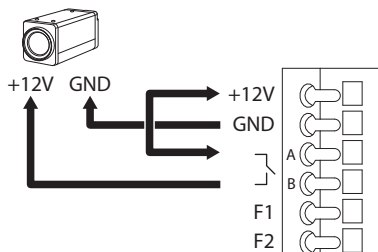

Fig. 11 CN7.

Ottiche con motori ad inversione di polarità:
Eseguire le connessioni come illustrato in figura.

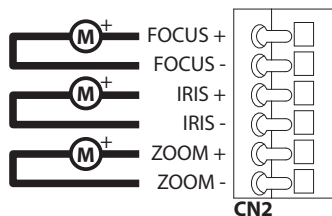

Fig. 12 CN2.

Ottiche con motori a filo comune: Abilitare la relativa opzione nel menu (10.1.13 Parametri Camera, pagina 38). Eseguire le connessioni come illustrato in figura.

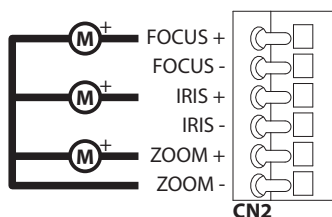

Fig. 13 CN2.

Potenziometri: Eseguire le connessioni come illustrato in figura.

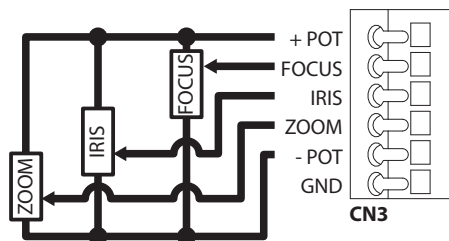

Fig. 14 CN3.

7.7.2 Regolazione della tensione di alimentazione dei motori delle ottiche

Prima di alimentare il brandeggio, selezionare la tensione di alimentazione delle ottiche agendo sul DIP1 (7.7 Descrizione della scheda della custodia, pagina 16).

REGOLAZIONE DELLA TENSIONE DI ALIMENTAZIONE DEI MOTORI DELLE OTTICHE		
SW1	SW2	Tensione
OFF	OFF	15Vdc
ON	OFF	12Vdc
OFF	ON	9Vdc
ON	ON	6Vdc

Tab. 3

7.7.3 Collegamento della linea di comunicazione

Collegare il cavo Ethernet alla telecamera.

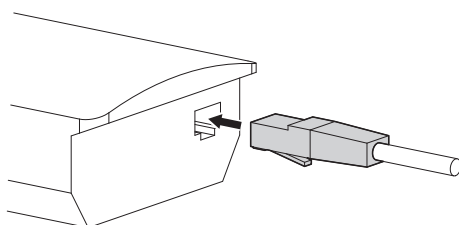

Fig. 15

i Raggruppare il cavo in eccesso per evitare interferenze con il funzionamento del tergcristallo (nelle versioni che ne sono equipaggiate).

8 Installazione



Non effettuare per nessun motivo alterazioni o collegamenti non previsti in questo manuale. Il mancato rispetto delle indicazioni fornite nel manuale in merito ai collegamenti può portare a gravi pericoli per la sicurezza del personale e dell'impianto.



Non modificare i cablaggi già presenti nel prodotto. Il mancato rispetto di questa indicazione può portare a gravi pericoli per la sicurezza del personale e dell'impianto, oltre a far decadere la garanzia.



In caso di utilizzo del kit lavavetro, il supporto per l'ugello deve essere installato prima del posizionamento del brandeggio dei cablaggi. Per ulteriori chiarimenti, fare riferimento al manuale del kit specifico.

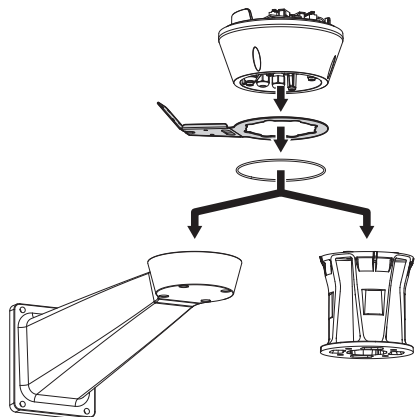

Fig. 16



All'interno della calotta inferiore è presente un sacchetto disidratante utile per evitare la formazione di umidità nella base ed in corrispondenza alle schede connettori. Rimuovere il sacchetto prima dell'installazione.

8.1 Collegamento dei cavi alla base

Introdurre i cavi all'interno dei pressacavi tenendo la base a circa 20cm dal supporto. Serrare i pressacavi. I pressacavi sono adatti per cavi con diametro compreso tra 5mm e 10mm.

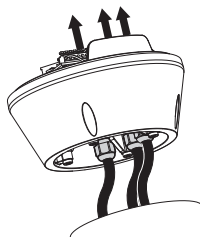

Fig. 17



Prestare attenzione durante il fissaggio. Coppia di serraggio: 5Nm.



Per cavi di diametro da 3mm a 7mm utilizzare gli appositi gommini in dotazione.

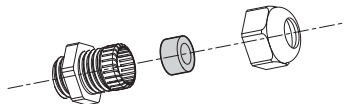

Fig. 18

8.2 Fissaggio della base al supporto

⚠ Utilizzare le viti e le rondelle fornite con la base.

Dopo aver posizionato la guarnizione (01), fissare la base (02) sul supporto (03) utilizzando le viti (04), le rondelle dentellate (05) e gli anelli per vite (06).

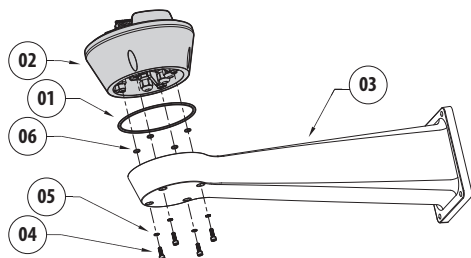

Fig. 19

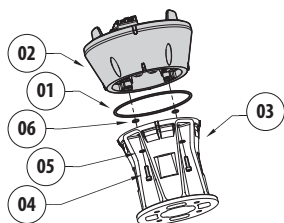

Fig. 20

Allineare le 3 tacche sulla base con quelle presenti sui supporti come illustrato nella figura seguente.

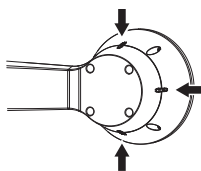

Fig. 21

⚠ Applicare del frenafili nei fori delle viti (Loctite 243®).

⚠ Prestare attenzione durante il fissaggio. Coppia di serraggio: 4Nm.

8.3 Descrizione della scheda connettori

DESCRIZIONE DELLA SCHEDA CONNETTORI

Connettore/Componente	Funzione
CN1	Alimentazione della scheda
CN4	Cavi di segnale
Ethernet	Ethernet
F1	Fusibile
F2	Fusibile

Tab. 4

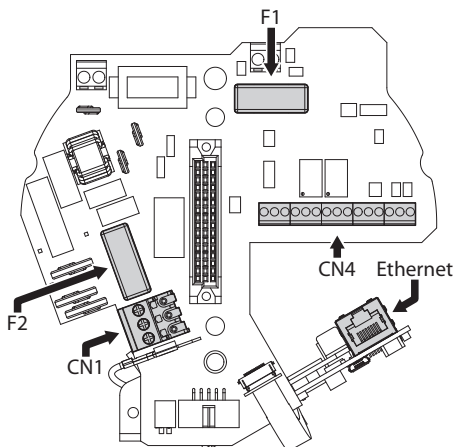

Fig. 22

8.4 Collegamento della linea di alimentazione

A seconda della versione, al dispositivo possono essere fornite diverse tensioni di alimentazione. Il loro valore è riportato nell'etichetta identificativa del prodotto (4.2 Marcatura del prodotto, pagina 10).



Eeguire le connessioni elettriche in assenza di alimentazione e con dispositivo di sezionamento aperto.



All'atto dell'installazione controllare che le caratteristiche di alimentazione fornite dall'impianto corrispondano a quelle richieste dal dispositivo.



Controllare che le fonti di alimentazione ed i cavi di collegamento siano in grado di sopportare il consumo del sistema.



Il cavo di terra deve essere più lungo degli altri due di circa 10mm per prevenirne il distacco accidentale a causa dello stiramento.



Il cavo di alimentazione deve essere coperto con la guaina siliconica (01) presente nella dotazione. La guaina siliconica deve essere fissata con l'apposita fascetta (02).

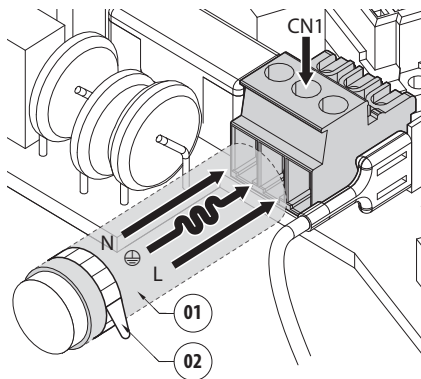

Fig. 23

8.4.1 Collegamento della linea di alimentazione in 24Vac

⚠ Per i prodotti marcati UL alimentati a 24Vac, utilizzare un trasformatore UL listed Classe 2, conforme alle normative vigenti.

Tagliare a misura i cavi e realizzare i collegamenti. Collegare la linea di alimentazione al seguente morsetto: CN1.

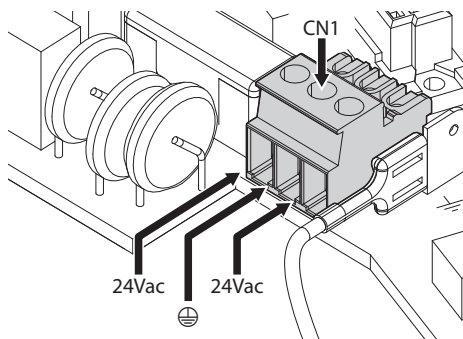

Fig. 24

Collegare i cavi di alimentazione come descritto nella tabella sottostante.

COLLEGAMENTO DELLA LINEA DI ALIMENTAZIONE	
Colore	Morsetti
Alimentazione 24Vac	
Definito dall'installatore	24Vac
Definito dall'installatore	24Vac
Giallo/Verde	⊕

Tab. 5

8.4.2 Collegamento della linea di alimentazione in 120Vac e 230Vac

Tagliare a misura i cavi e realizzare i collegamenti. Collegare la linea di alimentazione al seguente morsetto: CN1.

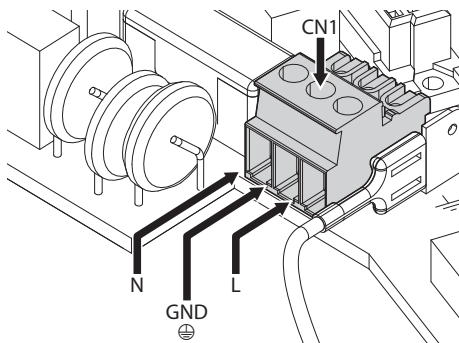

Fig. 25

Collegare i cavi di alimentazione come descritto nella tabella sottostante.

COLLEGAMENTO DELLA LINEA DI ALIMENTAZIONE	
Colore	Morsetti
Alimentazione 230Vac	
Blu	N (Neutro)
Marrone	L (Fase)
Giallo/Verde	⊕
Alimentazione 120Vac	
Blu	N (Neutro)
Marrone	L (Fase)
Giallo/Verde	⊕

Tab. 6

8.4.3 Collegamento degli ingressi di allarme, dell'interruttore crepuscolare e dei relè



ATTENZIONE! L'installazione è di tipo TNV-1. Non collegare a circuiti SELV.



ATTENZIONE! Per ridurre il rischio di incendio usare solamente cavi certificati UL Listed o CSA aventi dimensioni maggiori o uguali a 0.13mm² (26 AWG).

Versione standard

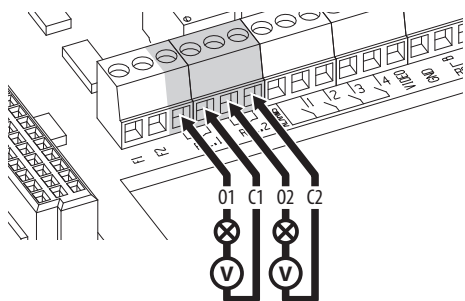

Fig. 26 Collegamento dei contatti dei relè.

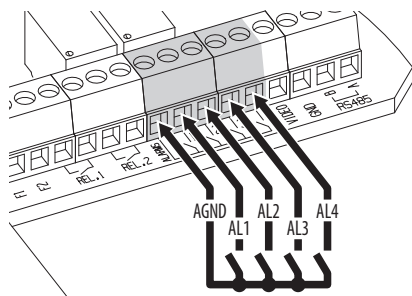

Fig. 27 Collegamento degli allarmi.

Versione con illuminatori a LED

COLLEGAMENTO DEGLI INGRESSI DI ALLARME, DELL'INTERRUTTORE CREPUSCOLARE E DEI RELÈ

AL1, AL2, AL3, AL4 e AGND	Ingressi di allarme auto-alimentati riferiti al morsetto comune AGND
O1-C1 e O2-C2	Contatti puliti di uscita attivabili da allarme o da comando utente

Tab. 7



Collegare l'interruttore crepuscolare ai morsetti AGND e AL1. Il contatto di allarme AL1 è dedicato di default all'interruttore crepuscolare.

8.5 Collegamento del cavo di rete Ethernet

Collegare il cavo Ethernet al connettore (8.3 Descrizione della scheda connettori, pagina 19).

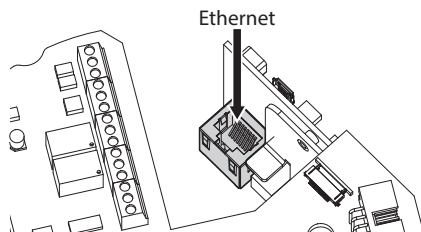

Fig. 28

8.6 Fissaggio del corpo superiore

Fissare il corpo superiore (01) alla base (02) tramite le viti di fissaggio (03) dotate di guarnizioni (04). Controllare che sia presente e in buono stato la guarnizione della base (05).

**⚠ Prestare attenzione durante il fissaggio.
Coppia di serraggio: 4Nm.**

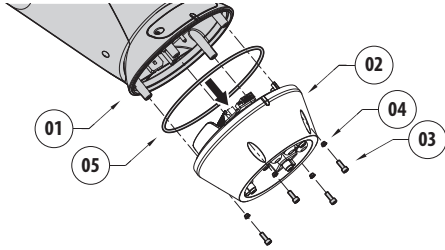

Fig. 29

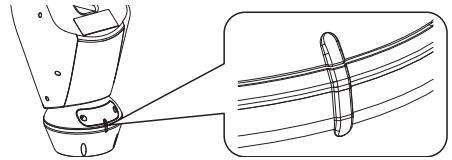

Fig. 30

i Esiste un'unica posizione di ancoraggio tra la base e corpo superiore. Allineare le sporgenze laterali per un corretto posizionamento.

8.7 Montaggio degli illuminatori a LED



Per un corretto funzionamento si devono sempre installare entrambi gli illuminatori.



Sul brandeggio è possibile installare esclusivamente illuminatori VIDEOTEC.

8.7.1 Montaggio della staffa

Posizionare la staffa (01) sulla parte inferiore della custodia come illustrato in figura. Inserire le viti e le rondelle (02) nei fori (03) e serrarle. Verificare che il fissaggio sia solido. Non utilizzare materiali non forniti nel kit.

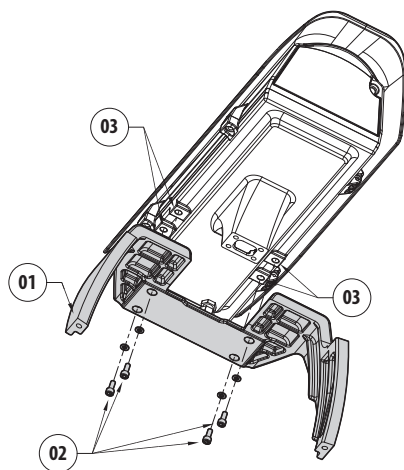

Fig. 31



Prestare attenzione durante il fissaggio.
Coppia di serraggio: 4Nm.

8.7.2 Montaggio dell'illuminatore sulla staffa

Posizionare i fissaggi dell'illuminatore (01) su quelli della staffa (02).

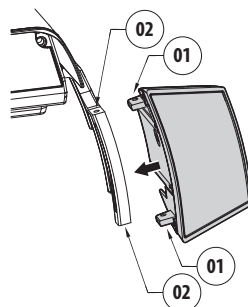

Fig. 32

Avvitare le viti con le rondelle precedentemente rimosse.

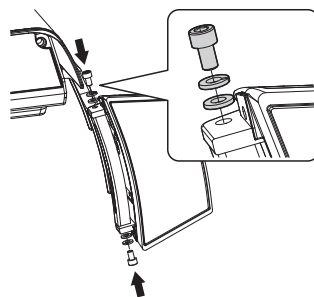

Fig. 33



Prestare attenzione durante il fissaggio.
Coppia di serraggio: 6Nm.

8.8 Collegamento degli illuminatori a LED

Aprire la custodia come descritto (Fig. 7, pagina 15).

Inserire i cavi di alimentazione per almeno 25cm attraverso i pressacavi.

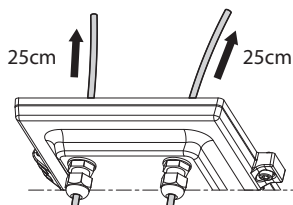
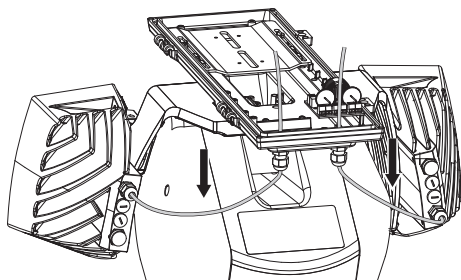

Fig. 34

⚠ Per non compromettere la sicurezza e il funzionamento dell'unità non lasciare eccedenza di cavo all'esterno.



Collegare i cavi come illustrato in figura.

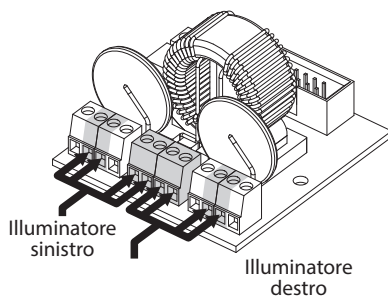

Fig. 35

COLLEGAMENTO DEGLI ILLUMINATORI A LED			
Illuminatore sinistro		Illuminatore destro	
Riferimento sulla scheda	Colore del cavo	Riferimento sulla scheda	Colore del cavo
WH	Bianco	WH	Bianco
BK	Nero	BK	Nero
A1	Verde	A2	Verde
B1	Rosso	B2	Rosso

Tab. 8

8.9 Sacchetto disidratante

Fissare il sacchetto disidratante con l'apposita staffa.

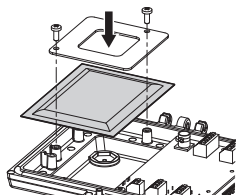

Fig. 36

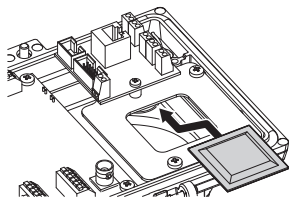

Fig. 37 Presente nelle versioni con illuminatori a LED.

8.10 Regolazione degli illuminatori a LED e modalità di sincronizzazione con la telecamera



Una volta effettuata la regolazione l'illuminatore di sinistra (MASTER) sincronizza e controlla l'illuminatore di destra (SLAVE).

L'interruttore crepuscolare rileva la luce ambientale e controlla l'accensione e lo spegnimento degli illuminatori quando la luminosità raggiunge il livello impostato dall'utilizzatore.

Quando gli illuminatori a LED sono attivi la telecamera passa in modalità notte tramite l'apposito comando ONVIF.

8.10.1 Descrizione dell'illuminatore a LED



Per non compromettere la sicurezza e il funzionamento dell'illuminatore non rimuovere la vite trasparente del sensore crepuscolare.

- **Sensore crepuscolare:** Rileva il livello di luminosità.
- **Cavo:** Alimentazione e controllo.
- **Regolatore soglia accensione:** Il potenziometro permette di regolare il livello di sensibilità per l'accensione dell'illuminatore.
- **Regolatore potenza infrarossi:** Il potenziometro permette di regolare la potenza dell'illuminatore.

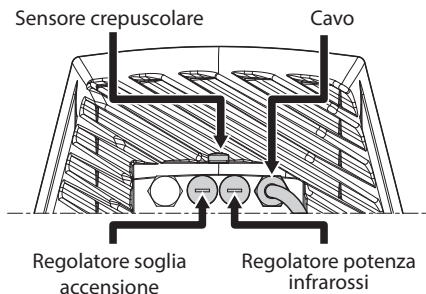

Fig. 38

8.10.2 Sincronizzazione con un interruttore crepuscolare esterno

Per sincronizzare gli illuminatori e la telecamera con un crepuscolare esterno è necessario:

- Collegare l'interruttore crepuscolare ai morsetti: AL1/AGND (8.4.3 Collegamento degli ingressi di allarme, dell'interruttore crepuscolare e dei relè, pagina 22).
- Regolare l'illuminatore sinistro (MASTER):
 - **Soglia di accensione:** Impostare il valore su OFF (8.10.5 Regolazione della soglia di accensione degli illuminatori a LED, pagina 28).
 - **Potenza degli infrarossi:** Impostare il valore secondo necessità (8.10.6 Regolazione della potenza degli illuminatori a LED, pagina 28).
- Regolare l'illuminatore destro (SLAVE):
 - **Soglia di accensione:** Impostare il valore al massimo (8.10.5 Regolazione della soglia di accensione degli illuminatori a LED, pagina 28).
 - **Potenza degli infrarossi:** Impostare il valore al minimo (8.10.6 Regolazione della potenza degli illuminatori a LED, pagina 28).

Dalla voce Sonda IR selezionare l'opzione Esterna (10.1.13 Parametri Camera, pagina 38).

Nella scheda I/O Digitali impostare i valori nel seguente modo (10.1.11 I/O Digitali, pagina 37):

- **ID Allarme:** 1
- **Tipo:** NORMALMENTE APERTO
- **Azione:** IR_FILTER

8.10.3 Sincronizzare l'unità con gli illuminatori a LED

Per sincronizzare l'unità con gli illuminatori a LED è necessario:

- Regolare l'illuminatore sinistro (MASTER):
 - **Soglia di accensione:** Impostare il valore secondo necessità (8.10.5 Regolazione della soglia di accensione degli illuminatori a LED, pagina 28).
 - **Potenza degli infrarossi:** Impostare il valore secondo necessità (8.10.6 Regolazione della potenza degli illuminatori a LED, pagina 28).

- Regolare l'illuminatore destro (SLAVE):
 - **Soglia di accensione:** Impostare il valore al massimo (8.10.5 Regolazione della soglia di accensione degli illuminatori a LED, pagina 28).
 - **Potenza degli infrarossi:** Impostare il valore al minimo (8.10.6 Regolazione della potenza degli illuminatori a LED, pagina 28).

Dalla voce Parametri Camera selezionare l'opzione Interna (10.1.13 Parametri Camera, pagina 38).

8.10.4 Attivazione manuale degli illuminatori a LED

Se si desidera attivare l'illuminatore a LED è necessario:

- Regolare l'illuminatore sinistro (MASTER):
 - **Soglia di accensione:** Impostare il valore su OFF (8.10.5 Regolazione della soglia di accensione degli illuminatori a LED, pagina 28).
 - **Potenza degli infrarossi:** Impostare il valore secondo necessità (8.10.6 Regolazione della potenza degli illuminatori a LED, pagina 28).
- Regolare l'illuminatore destro (SLAVE):
 - **Soglia di accensione:** Impostare il valore al massimo (8.10.5 Regolazione della soglia di accensione degli illuminatori a LED, pagina 28).
 - **Potenza degli infrarossi:** Impostare il valore al minimo (8.10.6 Regolazione della potenza degli illuminatori a LED, pagina 28).

8.10.5 Regolazione della soglia di accensione degli illuminatori a LED

! L'illuminatore destro deve sempre essere impostato a luminosità massima.

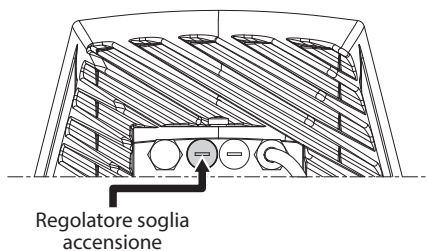

Fig. 39

L'illuminatore ha un sensore crepuscolare integrato che consente l'accensione e lo spegnimento automatico a condizioni luminose prestabilite.

La regolazione del sensore crepuscolare è effettuata in fabbrica ad un livello luminoso prefissato ed idoneo alla maggior parte delle installazioni (circa 50lx). Nel caso si voglia regolare in maniera diversa la soglia di intervento, svitare il tappo posizionato sul retro dell'illuminatore e provvedere alla regolazione tramite un cacciavite.

Ruotando il trimmer in senso orario la commutazione in modalità notturna è anticipata (ad un valore di luminosità maggiore). Ruotando il trimmer in senso antiorario la commutazione in modalità notturna è ritardata (ad un valore di luminosità inferiore).

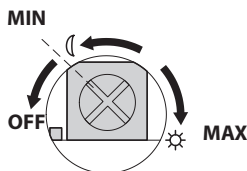

Fig. 40

Attendere le condizioni di luminosità adeguate per l'accensione dell'illuminatore. Ruotare lentamente il trimmer fino all'accensione del LED presente a lato del trimmer. Una volta oltrepassata la soglia di intervento (LED acceso), ruotare leggermente in senso opposto.

! Al termine delle regolazioni accertarsi che il tappo di chiusura sia adeguatamente serrato per garantire la tenuta ermetica del prodotto.

8.10.6 Regolazione della potenza degli illuminatori a LED

! L'illuminatore destro deve sempre essere impostato a potenza minima.

i L'illuminatore è regolato in fabbrica per erogare la massima potenza. Qualora non servisse illuminare dettagli lontani o se l'immagine risultasse sovraesposta per l'eccessiva luminosità, diminuire la potenza, ottenendo inoltre un risparmio energetico.

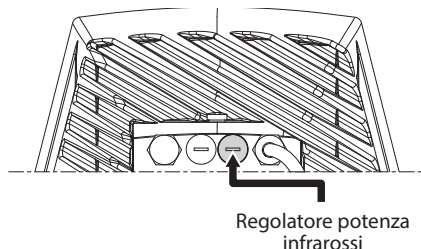

Fig. 41

Svitare il tappo di chiusura ermetica. Ruotare il trimmer in senso orario per aumentare la potenza degli infrarossi e in senso antiorario per diminuirli.



Fig. 42

! Al termine delle regolazioni accertarsi che il tappo di chiusura sia adeguatamente serrato per garantire la tenuta ermetica del prodotto.

8.11 Configurazione hardware

i La configurazione hardware è necessaria solo nel caso si voglia attivare la modalità di comunicazione via telemetria seriale. (12.1 Modifica della modalità di comunicazione (da protocollo ONVIF a telemetria seriale), pagina 42).

8.11.1 Apertura dello sportellino di configurazione

Prima di alimentare il dispositivo, è necessario configurarlo correttamente tramite i dip-switch presenti all'interno dello sportellino di configurazione. Aprire lo sportellino svitando le viti come illustrato in figura.

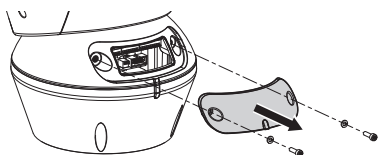

Fig. 43

I DIP-switch si presentano come illustrato in figura.

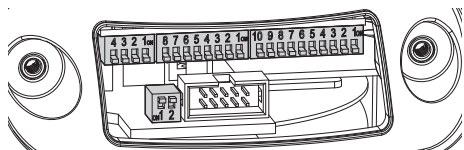

Fig. 44

i Al termine delle operazioni di installazione e cablaggio richiudere il prodotto.

8.11.2 Configurazione del DIP1

i La levetta dello switch verso l'alto rappresenta il valore 1 (ON). La levetta verso il basso rappresenta il valore 0 (OFF).

Lo switch 1 è utilizzato per l'aggiornamento del firmware.

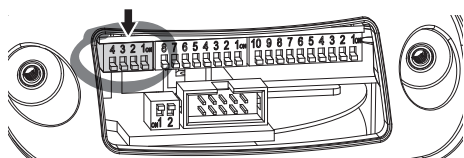

Fig. 45

CONFIGURAZIONE DEL DIP1					
Descrizione	SW 4	SW 3	SW 2	SW 1	Baud rate
Regolazione del baud rate	OFF	OFF	OFF	-	300 baud
	ON	OFF	OFF	-	600 baud
	OFF	ON	OFF	-	1200 baud
	ON	ON	OFF	-	2400 baud
	OFF	OFF	ON	-	4800 baud
	ON	OFF	ON	-	9600 baud
	OFF	ON	ON	-	19200 baud
Aggiornamento firmware	-	-	-	ON	Programmazione abilitata
	-	-	-	OFF	Programmazione disabilitata

Tab. 9

8.11.3 Configurazione del DIP2

i La levetta dello switch verso l'alto rappresenta il valore 1 (ON). La levetta verso il basso rappresenta il valore 0 (OFF).

Il brandeggio è controllabile mediante vari protocolli.

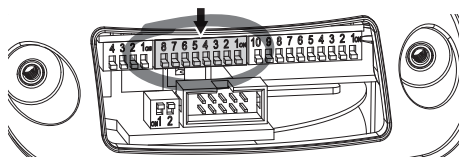

Fig. 46

CONFIGURAZIONE DEL DIP2								
Protocollo	SW 8	SW 7	SW 6	SW 5	SW 4	SW 3	SW 2	SW 1
PTZ Manager ¹	OFF	OFF	OFF	OFF	OFF	OFF	OFF	OFF
MACRO (VIDEOTEC)	OFF	OFF	OFF	OFF	OFF	ON	ON	ON
PANASONIC	OFF	OFF	OFF	ON	OFF	ON	OFF	OFF
PELCO D	OFF	OFF	OFF	OFF	ON	OFF	OFF	ON
AMERICAN DYNAMICS	OFF	OFF	OFF	OFF	ON	ON	ON	OFF
VISTA	OFF	OFF	OFF	ON	OFF	OFF	ON	ON

Tab. 10 ¹ Configurazione di default: MACRO (VIDEOTEC), 115200 baud, RS-232, Indirizzo 1. Questa opzione non richiede il settaggio dei DIP-switch (DIP1, DIP3).

Tab. 11

8.11.4 Configurazione del DIP3

i La levetta dello switch verso l'alto rappresenta il valore 1 (ON). La levetta verso il basso rappresenta il valore 0 (OFF).

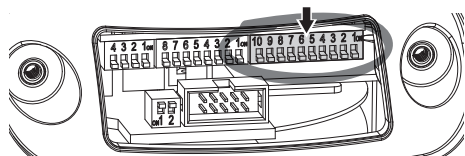

Fig. 47

8.11.4.1 Configurazione dell'indirizzo

Gli switch da 1 a 8 sono utilizzati per configurare l'indirizzo dell'unità (da 1 a 255).

La selezione dell'indirizzo avviene secondo la codifica binaria (A Appendice - Tabella degli indirizzi, pagina 50).

8.11.4.2 Configurazione delle linee di comunicazione seriali

Il prodotto prevede una linea seriale di comunicazione RS-485 e una linea seriale RS-232.

Gli switch 10 e 9 sono utilizzati per configurare le linee seriali.

CONFIGURAZIONE DEL DIP3		
Descrizione	SW 10	SW 9
Comunicazione monodirezionale sulla linea RS-485-1. Comunicazione bidirezionale sulla linea RS-232.	OFF	OFF
Comunicazione bidirezionale, half-duplex, sulla linea RS-485-1.	ON	ON

Tab. 12

8.11.5 Configurazione del DIP4

i Il settaggio di questo DIP avviene in maniera inversa dai precedenti. La levetta dello switch verso l'alto rappresenta il valore 0 (OFF). La levetta verso il basso rappresenta il valore 1 (ON).

Sulla scheda sono presenti due switch usati per configurare la terminazione (120 Ohm) delle linee seriali.

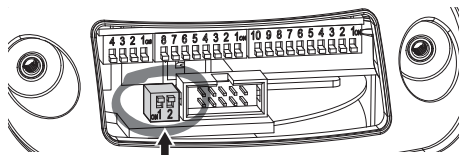

Fig. 48

Ogni unità che si trovi a fine linea deve essere terminata utilizzando l'apposito switch in modo da evitare riflessioni e deformazioni del segnale.

CONFIGURAZIONE DEL DIP4			
Linea seriale	SW 2	SW 1	Descrizione
Factory default	-	ON	Abilitato
	-	OFF	Disabilitato
Linea RS-485-1	ON	-	Terminata
	OFF	-	Non terminata

Tab. 13

Per riportare il brandeggio in factory default fare riferimento al relativo capitolo (10.1.15 Factory Default, pagina 39).

9 Accensione



Assicurarsi che l'unità e gli altri componenti dell'impianto siano chiusi in modo idoneo a impedire il contatto con componenti sotto tensione.



Durante il normale funzionamento la superficie dell'illuminatore può raggiungere temperature elevate. Evitare il contatto diretto e posizionare l'apparecchiatura in luogo non accessibile al personale non autorizzato. Per qualunque operazione di manutenzione spegnere il dispositivo d'illuminazione e lasciarlo raffreddare per almeno 10 minuti.



Non sostare nei pressi del dispositivo quando alimentato. Agire sul dispositivo solo in assenza di alimentazione.



Accertarsi che tutte le parti siano fissate in maniera solida ed affidabile.



La procedura di preriscaldamento automatico (De-Ice) si potrebbe attivare tutte le volte che il dispositivo viene acceso ad una temperatura ambiente inferiore a 0°C. La procedura serve a garantire la corretta funzionalità del dispositivo anche alle basse temperature. La durata varia tra 60 e 105 minuti a seconda delle condizioni.

Collegare l'alimentazione elettrica per accendere l'unità.

Scollegare l'alimentazione elettrica per spegnere l'unità.

10 Configurazione

10.1 Interfaccia web

i Alla prima connessione assegnare un indirizzo diverso da 192.168.0.100.

i Browser supportati: Microsoft Internet Explorer, Google Chrome, Mozilla Firefox.

i Il MAC Address è riportato sull'etichetta presente sulla scheda CPU.

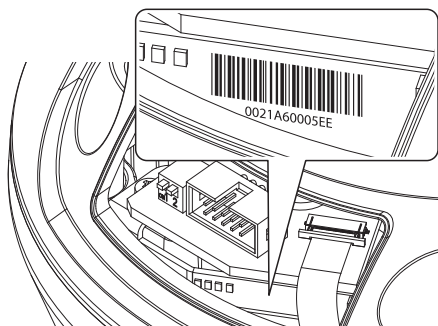

Fig. 49

La prima operazione per configurare il brandeggio consiste nel connettersi alla sua interfaccia web.

Nelle impostazioni predefinite il brandeggio è configurato per acquisire autonomamente un indirizzo mediante protocollo DHCP ed è possibile rilevare il dispositivo mediante il protocollo ONVIF, profilo S.

Nel caso in cui non sia disponibile alcun server DHCP, il brandeggio provvederà automaticamente a configurarsi con l'indirizzo 192.168.0.100.

Nel caso in cui non fosse disponibile un VMS con funzionalità di Auto Discovery mediante ONVIF, l'indirizzo acquisito può essere letto nei log del server DHCP.

Per accedere al brandeggio sarà sufficiente collegarsi con un browser all'indirizzo `http://indirizzo_ip` e effettuare il login al brandeggio con le credenziali predefinite:

- **Username:** admin
- **Password:** admin

10.1.1 Primo accesso

Per un corretto funzionamento, il brandeggio deve essere configurato in funzione della telecamera installata.

I parametri necessari sono:

- Il protocollo IP usato per comunicare con la telecamera.
- Il tipo di lenti installate (motorizzata, fissa o integrata).
- Le credenziali necessarie per connettersi alla camera IP (nome utente e password della telecamera installata).

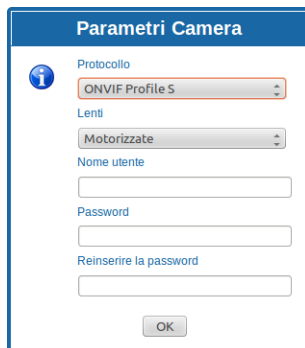

Fig. 50

! È necessario che la camera IP installata nel brandeggio sia configurata per acquisire l'indirizzo IP mediante DHCP.

10.1.2 Home

Se il login viene effettuato con successo verrà mostrata l'interfaccia di gestione del brandeggio.

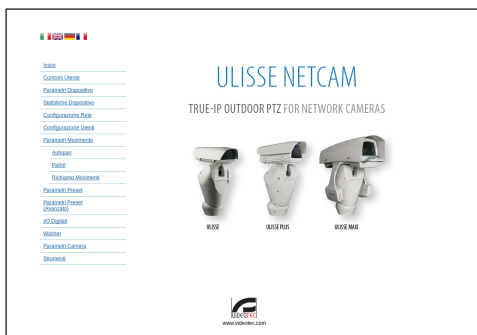

Fig. 51

10.1.3 Controlli Utente

Per controllare il brandeggio via browser, selezionare la voce Controlli Utente. Si aprirà una nuova finestra con una tastiera virtuale per inviare i comandi.

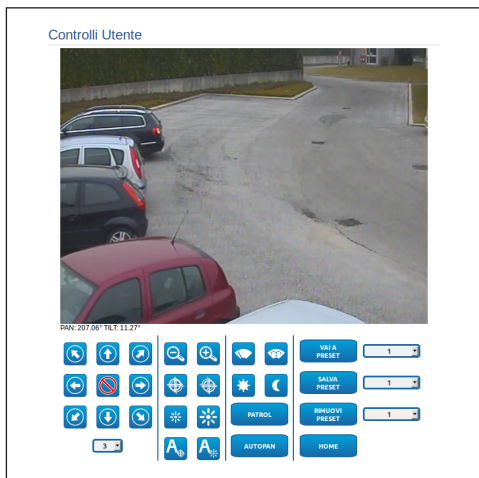

Fig. 52

Nella tastiera virtuale si trovano i seguenti comandi:

- **Selettore velocità:** Permette di selezionare la velocità dei movimenti del brandeggio.



Fig. 53

- **Zoom wide/Zoom tele**



Fig. 54

- **Focus far/Focus near/Auto focus**



Fig. 55

- **Iris close/Iris open/Auto iris**



Fig. 56

- **Wiper/Washer**



Fig. 57

- **Day:** Attiva il filtro IR della camera. Se presenti, spegne gli illuminatori a LED.



Fig. 58

- **Night:** Disattiva il filtro IR della camera. Se presenti, accende gli illuminatori a LED.



Fig. 59

10.1.4 Parametri Dispositivo

Alla voce del menu Parametri Dispositivo è possibile impostare il nome del brandeggio e visualizzare altre informazioni aggiuntive.

Parametri Dispositivo	
Nome Dispositivo	UlisseNet.cam
Codice Prodotto	UPT25VJAN00E
IT® seriale	113121290001
Indirizzo MAC	00:21:A6:00:07:D8
ID Prodotto	2
Versione Firmware: CPU Board	2.0
Versione Firmware: NET Board	6.0.0
Versione Firmware: NPP Board	6.0.0
Revisione Hardware	0
Major Rev.	0
Minor Rev.	0
Tipologia custodia	0

Fig. 60

10.1.5 Statistiche Dispositivo

Alla voce del menu Statistiche Dispositivo sono riportate per la sola consultazione tutte le statistiche raccolte durante il funzionamento del brandeggio.

Statistiche Dispositivo	
Grati Pan	153684
Grati TR	13182
Accessioni	361
Ore di lavoro	388
Temperatura massima custodia (°C)	36
Temperatura minima custodia (°C)	19
Temperatura massima scheda PAN (°C)	61
Temperatura minima scheda PAN (°C)	22
Temperatura massima scheda CPU (°C)	57
Temperatura minima scheda CPU (°C)	22
Temperatura massima scheda NET (°C)	50
Temperatura minima scheda NET (°C)	20

Fig. 61

10.1.6 Configurazione Rete

Alla voce del menu Configurazione Rete è possibile cambiare l'impostazione di rete del brandeggio. È possibile decidere se il dispositivo debba avere un indirizzo assegnato staticamente, dinamicamente con DHCP o autogenerato. Il dispositivo supporta il protocollo Internet Protocol (IP) in versione 4.

i Con indirizzo autogenerato il dispositivo provvederà automaticamente ad assegnarsi un indirizzo nel range 169.254.0.0/16.

Nella stessa pagina è possibile configurare 2 DNS e decidere quali meccanismi debbano essere attivi per identificare automaticamente i dispositivi nella rete locale.

Configurazione Rete	
Versione IP	IPv4
Tipo indirizzo	STATICO
Indirizzo IP (IPv4)	192.168.103.121
Subnet Mask (IPv4)	255.255.255.0
Gateway (IPv4)	192.168.103.1
Ricerca automatica DNS	DISABILITATO
Server DNS preferito	8.8.4.4
Server DNS alternativo	8.8.8.8
Date & Time	2013-05-27 14:42:16 UTC
Server NTP	DISABILITATO
PC Sync	ATTIVO
UPNP	ATTIVO
Zeroconf	ATTIVO
Multicast discovery	ATTIVO
WS discovery	ATTIVO

Fig. 62

È possibile inoltre specificare se il dispositivo debba sincronizzarsi con un server NTP (Network Time Protocol) esterno.

- **NTP -> DISABILITATO:** Selezionare questa opzione se non si desidera sincronizzare data e ora del dispositivo.
- **NTP -> DHCP:** Selezionare questa opzione nel caso si desideri sincronizzare data e ora del dispositivo con quelle di un server NTP (Network Time Protocol) indicato dal server DHCP.
- **NTP -> STATICO:** Selezionare questa opzione nel caso si desideri sincronizzare data e ora del dispositivo con quelle del server NTP specificato dall'indirizzo statico.

i Per un corretto funzionamento del dispositivo è necessario sincronizzare il brandeggio con il software VMS utilizzando un server NTP.

i Per un corretto funzionamento del dispositivo è necessario sincronizzare la camera con il brandeggio. Al fine di ottenere tale sincronizzazione, selezionare, dalla pagina web della camera, l'opzione NTP from DHCP, oppure specificare l'indirizzo 192.0.0.1 come indirizzo statico del server NTP.

10.1.7 Configurazione Utenti

Alla voce del menu Configurazione Utenti è possibile amministrare gli utenti che possono accedere al brandeggio. Gli utenti di tipo Administrator possono accedere alla configurazione del prodotto. Gli utenti di tipo Operator, User e Anonymous hanno accesso limitato alle pagine di gestione.



Fig. 63

i Il dispositivo può essere configurato solo da utenti con privilegi di amministratore.

10.1.8 Parametri Movimento

Alla voce del menu Parametri Movimento è possibile controllare via web tutti i parametri del brandeggio.

- **Offset Pan:** Il brandeggio ha una posizione di 0° definita meccanicamente. La funzione Offset Pan permette di definire via software una diversa posizione di 0°.
- **Velocità Massima:** Imposta la velocità manuale massima.
- **Velocità Con Zoom:** Abilita l'opzione Velocità con Zoom. Tale parametro, se abilitato, riduce automaticamente la velocità di Pan e Tilt in funzione del fattore di Zoom.
- **Fattore Tilt:** Imposta il fattore di riduzione della velocità manuale dell'asse tilt.
- **Limiti Pan:** Abilita i limiti del Pan.
- **Pan Inizio:** Imposta il limite iniziale del Pan.
- **Pan Fine:** Imposta il limite finale del Pan.
- **Tilt Inizio:** Imposta il limite iniziale del Tilt.
- **Tilt Fine:** Imposta il limite finale del Tilt.

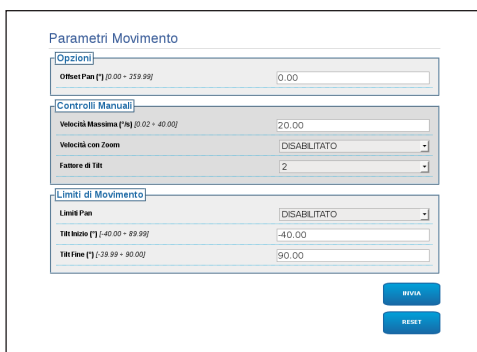

Fig. 64

10.1.8.1 Autopan

Nella sottosezione Autopan è possibile specificare il preset di inizio e di fine dell'autopan.

Fig. 65

10.1.8.2 Patrol

Nella sottosezione Patrol è possibile specificare il preset di inizio e di fine del patrol. È inoltre possibile specificare se la scansione dei preset debba avvenire in modo casuale o meno.

Fig. 66

10.1.8.3 Richiamo Movimenti

Nella sottosezione Richiamo Movimenti è possibile specificare un intervallo di tempo di inattività terminato il quale il brandeggio provvederà ad eseguire una delle seguenti funzioni: ritorno alla posizione Home, avvio dell'autopan o avvio del patrol.

Fig. 67

10.1.9 Parametri Preset

Alla voce del menu Parametri Preset sono configurabili alcuni parametri relativi ai preset:

- **Velocità Scan:** La velocità in gradi al secondo con cui viene raggiunto un preset su richiesta esplicita dell'operatore.
- **Tipo Di Rampa:** Permette di selezionare le accelerazioni del brandeggio.
- **Velocità Movimenti (Default):** La velocità usata nelle operazioni di autopan e patrol.
- **Imponi Velocità Di Default:** La velocità di default verrà impostata anche come velocità di scan per tutti i preset.
- **Pausa Default:** Il tempo in secondi di permanenza di default in ogni preset.
- **Imponi Pausa Di Default:** La pausa di default verrà impostata per tutti i preset.

Fig. 68

10.1.10 Parametri Preset (Avanzato)

Nella sezione Parametri Preset (Avanzato) è possibile personalizzare i valori di velocità e pausa per ciascun preset, oltre che ad abilitare/disabilitare i preset stessi.

Fig. 69

10.1.11 I/O Digitali

Nella scheda I/O Digitali è possibile configurare i canali digitali presenti nel brandeggio. Segue una breve descrizione dei parametri configurabili per ciascun ingresso digitale.

- **ID Allarme:** Campo utilizzato per selezionare l'ingresso digitale desiderato.
- **Tipo:** Indica lo stato di default dell'ingresso digitale. Può essere impostato su Normalmente Aperto o Normalmente Chiuso.
- **Azione:** A ciascun ingresso può essere associata un'azione. L'azione viene attivata nel momento in cui il contatto passa in uno stato diverso da quello di default. Di seguito sono elencate le azioni disponibili:
 - **NONE:** Nessuna azione.
 - **SCAN:** Posiziona il brandeggio sul preset selezionato.
 - **PATROL:** Attiva il PATROL.
 - **AUTOPAN:** Attiva l'AUTOPAN.
 - **WIPER:** Attiva il Wiper.
 - **WASHER:** Attiva la sequenza di lavaggio del vetro.
 - **RELE' 1:** Attiva il Relè 1.
 - **RELE' 2:** Attiva il Relè 2.
 - **IR FILT:** Disattiva il Filtro IR della camera. Se presenti, accende gli illuminatori a LED.

Per un controllo del corretto funzionamento degli allarmi, nella pagina web è presente un pallino. Il pallino sarà verde in condizioni normali e rosso quando viene rilevato un allarme.

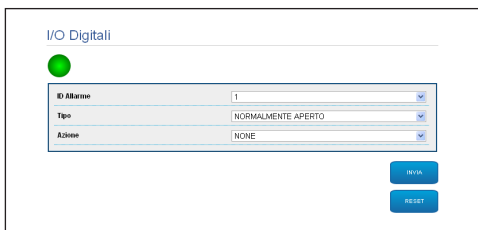

Fig. 70

10.1.12 Washer

La pompa per il lavaggio del brandeggio è configurata nella scheda Washer dove è possibile associare un preset all'operazione di lavaggio, impostare la durata del lavaggio del vetro e specificare il ritardo di attivazione e disattivazione del tergicristallo.

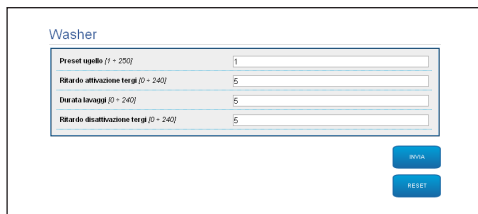

Fig. 71

10.1.13 Parametri Camera

I parametri della camera IP che sono stato impostati al primo avvio sono modificabili alla voce del menu Parametri Camera. Alla voce del menu Parametri Camera è possibile inoltre specificare il fattore di zoom e la precisione della posizione dello zoom. In questa sezione è possibile anche visualizzare i dati relativi ai diversi profili ONVIF esportati dalla camera.

Alla voce del menu Lenti è possibile selezionare una delle seguenti opzioni:

- **Motorizzate:** Controllo da brandeggio.
- **Integrate:** Controllo da telecamera.
- **Fisse:** Non controllabili.

Nel caso di lenti motorizzate sarà possibile impostare la connessione (a filo comune o a polarità inversa) e la polarità di rotazione dello Zoom, del Focus e dell'Iris.

Fig. 72

Per modificare le impostazioni della telecamera selezionare il pulsante VTunnel (10.1.14 Strumenti, pagina 38).

10.1.14 Strumenti

Alla voce del menu Strumenti è possibile reimpostare i valori predefiniti per tutta la configurazione del brandeggio o solo per alcune sezioni specifiche.

In questa sezione è inoltre possibile:

- Aggiornare il firmware del dispositivo.
- Riavviare il brandeggio.
- Scaricare l'applicativo VTunnel per abilitare la connessione con la camera IP indispensabile per accedere alla pagina web della stessa.

Fig. 73

10.1.15 Factory Default

⚠ Se la password di accesso non è più disponibile, è possibile ripristinare le impostazioni di fabbrica tramite un tasto di Reset, situato all'interno del prodotto.

Per ripristinare le impostazioni di fabbrica relative alla rete, all'accesso utenti e alla configurazione della camera seguire la procedura:

- Alimentare l'unità.
- Aprire lo sportellino dei DIP-switch.
- Localizzare il DIP-switch 4 (01). Portare lo switch 1 verso il basso, valore 1 (ON).
- Attendere lo spegnimento temporaneo dei LED (02).
- Riportare lo switch 1 verso l'alto, valore 0 (OFF).
- Chiudere lo sportellino.

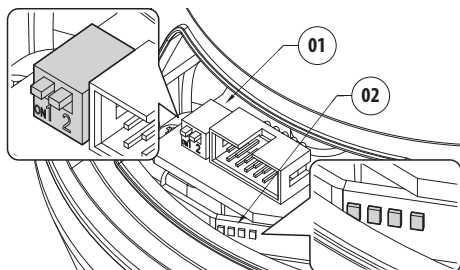

Fig. 74

10.2 VTTunnel

i L'applicativo funziona solo con Java™. Se Java™ non è stato precedentemente installato scaricare l'ultima versione dal sito www.java.com.

i L'applicativo può collegarsi solo alla prima interfaccia di rete attiva. Lasciare connesso solo il cavo di rete collegato al brandeggio.

i L'esecuzione dell'applicativo richiede i privilegi di amministrazione del computer. Potrebbe apparire a monitor il messaggio **You have to execute javaw as administrator**. In questo caso sarà necessario modificare le proprietà di esecuzione del file `javaw.exe` situato nella cartella di installazione di Java.

Per potersi connettere all'interfaccia web della telecamera è necessario utilizzare l'applicativo VTTunnel, avviabile dalla voce di menu Strumenti.

All'avvio dell'applicativo verrà mostrato un elenco di dispositivi collegati in rete. Per collegarsi alla camera è necessario selezionare il brandeggio desiderato e premere il tasto Connect.

Una volta stabilita la connessione, la pagina web della telecamera IP sarà raggiungibile all'indirizzo 192.0.0.64.

Terminate le operazioni sulla telecamera, si potrà chiudere la connessione premendo il tasto Disconnect. È possibile collegarsi ad una sola telecamera alla volta, quindi è necessario disconnettersi dal brandeggio prima di poter operare su un'altra unità di posizionamento.

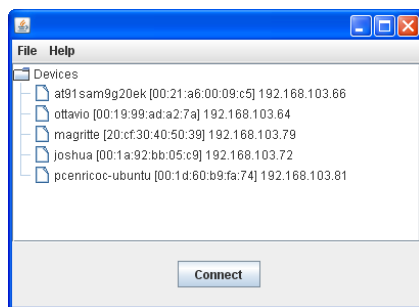

Fig. 75

i Se durante la configurazione della telecamera vengono modificati i parametri di streaming video è necessario riavviare il brandeggio.

11 Accessori

i Per ulteriori dettagli sulla configurazione e l'utilizzo fare riferimento al manuale del relativo accessorio.

11.1 Impianto di lavaggio

Il brandeggio può essere dotato di una pompa esterna che fornisce acqua per la pulizia del vetro.

Quando si invia il comando il brandeggio si posiziona con la finestra di fronte all'ugello (10.1.3 Controlli Utente, pagina 33). Vengono attivati la pompa ed il tergicristallo per un tempo determinato. Alla fine della procedura il brandeggio ritorna nella posizione iniziale.

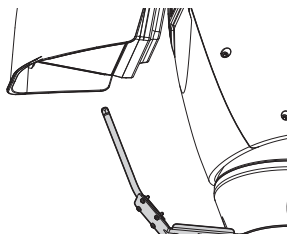

Fig. 76

11.1.1 Collegamento dell'impianto di lavaggio

! **ATTENZIONE!** L'installazione è di tipo TNV-1. Non collegare a circuiti SELV.

! **ATTENZIONE!** Per ridurre il rischio di incendio usare solamente cavi certificati UL Listed o CSA aventi dimensioni maggiori o uguali a 0.13mm² (26 AWG).

! **Tutti i cavi di segnale devono essere raggruppati con una fascetta.**

COLLEGAMENTO DELL'IMPIANTO DI LAVAGGIO	
Morsetti	Descrizione
O1-C1	Contatto pulito per attivazione dell'impianto di lavaggio.

Tab. 14

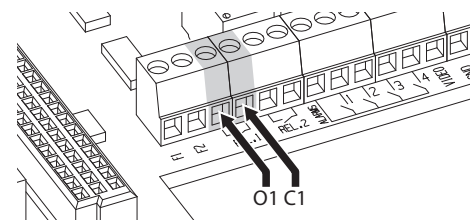

Fig. 77

11.2 Supporto da parete

Supporto per montaggio a parete con passaggio interno cavi.

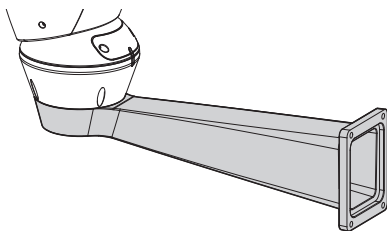

Fig. 78

11.3 Supporto da parapetto

Supporto per montaggio a parapetto con passaggio interno cavi.

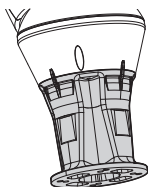

Fig. 79

11.4 Alimentatore con controllo degli illuminatori

Scatola stagna con alimentatore e controllo degli illuminatori.

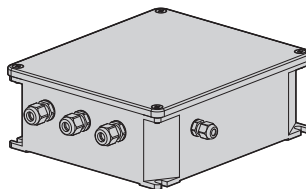

Fig. 80 Versione della scatola standard.

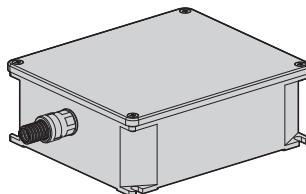

Fig. 81 Versione della scatola certificata UL.



Per ulteriori informazioni fare riferimento al relativo capitolo (8.4.3 Collegamento degli ingressi di allarme, dell'interruttore crepuscolare e dei relè, pagina 22).

12 Istruzioni di funzionamento eccezionale

12.1 Modifica della modalità di comunicazione (da protocollo ONVIF a telemetria seriale)

Il brandeggio è nativamente configurato per comunicare via protocollo ONVIF.

12.1.1 Procedura di modifica della modalità di comunicazione

Spegnere il brandeggio.

Settare i dip-switch (8.11 Configurazione hardware, pagina 29). Seguire la procedura indicata di seguito:

Baud rate: 38400 (ON ON ON OFF)

Protocollo: MACRO (OFF OFF OFF OFF OFF ON ON ON)

Comunicazione seriale e indirizzo di telemetria:
RS-485 half-duplex, indirizzo 1 (ON ON OFF OFF OFF OFF OFF ON)

Accendere il brandeggio.

Da browser, digitare l'indirizzo <indirizzo_ip>/cgi-bin/pc.cgi.



Fig. 82

Cambiare il codice prodotto: la lettera N viene sostituita da Y. Esempio: Da UPT2SVUAN00E a UPT2SVUAY00E.

Fare Click su Invia. Confermare il riavvio del prodotto.

Da browser, digitare l'indirizzo <indirizzo_ip>/cgi-bin/pc.cgi per verificare che il codice prodotto sia stato cambiato. In caso di problemi ripetere la procedura dall'inizio.

Spegnere il brandeggio.

Portare su OFF i dip-switch illustrati in figura.

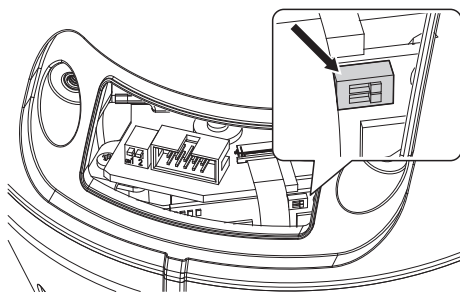

Fig. 83

Configurare la comunicazione seriale del brandeggio come richiesto dalla telecamera. Agire sui dip-switch delle comunicazioni seriali. (8.11 Configurazione hardware, pagina 29).

Connettere la porta seriale della telecamera al connettore.

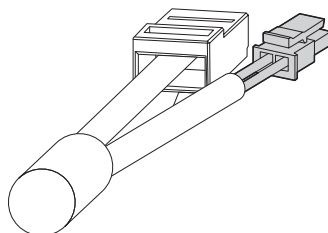

Fig. 84 Grigio: RS-485 +. Rosa: RS-485 -.

Collegare l'alimentazione della telecamera.

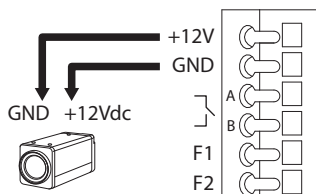

Fig. 85

Accendere il brandeggio.

Il brandeggio è ora configurato per comunicare via telemetria seriale (RS-485).

13 Manutenzione

 **La manutenzione deve essere eseguita solo da personale qualificato ad intervenire su circuiti elettrici.**

13.1 Sostituzione dei fusibili

 **Eeguire la manutenzione in assenza di alimentazione e con il dispositivo di sezionamento aperto.**

In caso di necessità sostituire il fusibile illustrato in figura (8.3 Descrizione della scheda connettori, pagina 19).

SOSTITUZIONE DEI FUSIBILI		
Tensione	Fusibile F1	Fusibile F2
24Vac, 50/60Hz	F 6.3A L 250V 5x20	T 8A H 250V 5x20
120Vac, 50/60Hz	F 6.3A L 250V 5x20	T 4A H 250V 5x20
230Vac, 50/60Hz	F 6.3A L 250V 5x20	T 2A H 250V 5x20

Tab. 15

14 Pulizia

14.1 Pulizia del vetro e delle parti in plastica

 **Evitare alcool etilico, solventi, idrocarburi idrogenati, acidi forti e alcali. L'utilizzo di detti prodotti danneggia in modo irreparabile la superficie trattata.**

Si consiglia di utilizzare un panno morbido con saponi neutri diluiti con acqua o prodotti specifici per la pulizia delle lenti degli occhiali.

14.2 Pulizia della finestra in germanio

 **Pulire la finestra prestando attenzione a non graffiare o rigare la superficie esterna trattata con carbon coating. Danneggiando tale rivestimento c'è il rischio di compromettere la trasparenza all'infrarosso della superficie.**

La pulizia deve essere effettuata con sapone neutro diluito con acqua.

15 Smaltimento dei rifiuti

 **Questo simbolo e il sistema di riciclaggio sono validi solo nei paesi dell'EU e non trovano applicazione in altri paesi del mondo.**

Il vostro prodotto è costruito con materiali e componenti di alta qualità, che sono riutilizzabili o riciclabili.

Prodotti elettrici ed elettronici che riportano questo simbolo, alla fine dell'uso, devono essere smaltiti separatamente dai rifiuti casalinghi.

Vi preghiamo di smaltire questo apparecchio in un Centro di raccolta o in un'Ecostazione.

Nell'Unione Europea esistono sistemi di raccolta differenziata per prodotti elettrici ed elettronici.

16 Risoluzione dei problemi

Richiedere l'intervento di personale qualificato quando:

- L'unità si è danneggiata a seguito di una caduta;
- Le prestazioni dell'unità hanno avuto un evidente peggioramento;
- L'unità non funziona correttamente anche se sono state seguite tutte le indicazioni riportate nel presente manuale.

PROBLEMA	Il prodotto non si accende.
CAUSA	<i>Errato cablaggio, rottura dei fusibili.</i>
SOLUZIONE	Verificare la corretta esecuzione delle connessioni. Verificare la continuità dei fusibili e, in caso di guasto, sostituirli con i modelli indicati.

PROBLEMA	Con particolari condizioni di zoom c'è interferenza della custodia o del tettuccio nell'immagine ripresa (solo per versioni con ottica motorizzata).
CAUSA	<i>Posizione della telecamera o dell'ottica troppo arretrata rispetto alla finestra.</i>
SOLUZIONE	Regolare la posizione della telecamera e dell'ottica.

PROBLEMA	Non è possibile collegarsi alla telecamera.
CAUSA	<i>Errato collegamento della telecamera.</i>
SOLUZIONE	Verificare i collegamenti della telecamera.

PROBLEMA	Durante l'accensione il brandeggio rimane bloccato.
CAUSA	<i>La temperatura ambiente è molto bassa.</i>
SOLUZIONE	Attendere il termine della procedura di preriscaldamento.

PROBLEMA	Non è possibile controllare il brandeggio.
CAUSA	<i>Errata configurazione della linea di comunicazione.</i>
SOLUZIONE	Verificare la configurazione dei dip-switch (8.11 Configurazione hardware, pagina 29).

17 Dati tecnici

17.1 Generale

Costruzione in pressofusione di alluminio e tecnopolimero
Verniciatura a polveri di epossipoliestere, colore RAL9002
Top mount (OTT)
Trasmissione per mezzo di cinghia dentata
Slip-ring
Finecorsa elettronici
Installazione semplificata grazie al connettore e facilità di sostituzione in loco
Assenza di gioco meccanico
Dotato di encoder per un perfetto posizionamento
Tergicristallo integrato
Configurazione parametri del protocollo di telemetria via dip-switch per RS485

17.2 Meccanica

Pressacavi: 3xM16
Rotazione orizzontale: continua
Rotazione verticale: da +90° a -40°
Velocità orizzontale (variabile): da 0.02°/s fino a 100°/s (da 0.02°/s fino a 40°/s, con illuminatori a LED)
Velocità verticale (variabile): da 0.02°/s fino a 50°/s (da 0.02°/s fino a 30°/s, con illuminatori a LED)
Dimensioni utili interne: Vedi disegni
Vetro della custodia (WxH): 124x112mm
Accuratezza del richiamo posizioni preset: 0.02°
Peso unitario: 16.8kg (17.8kg, con supporto per illuminatori a LED)

17.3 Elettrico

Adatto all'impiego con telecamere network

Tensione di alimentazione/Corrente assorbita:

- 230Vac, 0.4A, 50/60Hz
- 24Vac, 4A (8A con illuminatori a LED), 50/60Hz
- 120Vac, 0.8A, 50/60Hz

Potenza assorbita:

- 100W
- 150-190W max con illuminatori a LED in 24Vac
- 28.5W, brandeggio fermo, riscaldamento spento

Alimentazione telecamere: 12Vdc (800mA)

4 ingressi di allarme autoalimentati

2 contatti puliti: 30Vdc max o 30Vac, @ 1A

17.4 Comunicazioni

Connessione Ethernet: IEEE 802.3 100Base-Tx

17.5 Protocolli

ONVIF, profilo S

17.6 Ambiente

Interno/Esterno

Temperatura di esercizio

- Con riscaldamento: -20°C/+60°C
- Con riscaldamento potenziato: -30°C/+60°C

Immunità agli impulsi: fino a 2kV tra linea e linea, fino a 4kV tra linea e terra (Classe 4)

17.7 Certificazioni

Sicurezza elettrica (CE): EN60950-1, IEC60950-1

Compatibilità elettromagnetica (CE): EN50130-4, EN610000-6-4, EN55022 (Classe A), FCC Part 15 (Classe A)

Installazione all'esterno (CE): EN60950-22, IEC60950-22

Sicurezza fotobiologica (CE): EN62471 illuminatori a LED)

Grado di protezione IP: EN60529, IP66

Resistenza alla nebbia salina: EN50130-5, EN60068-2-52

Certificazione UL: cULus Listed (TYPE 4X)

Certificazione EAC

18 Disegni tecnici

i Le dimensioni dei disegni sono espresse in millimetri.

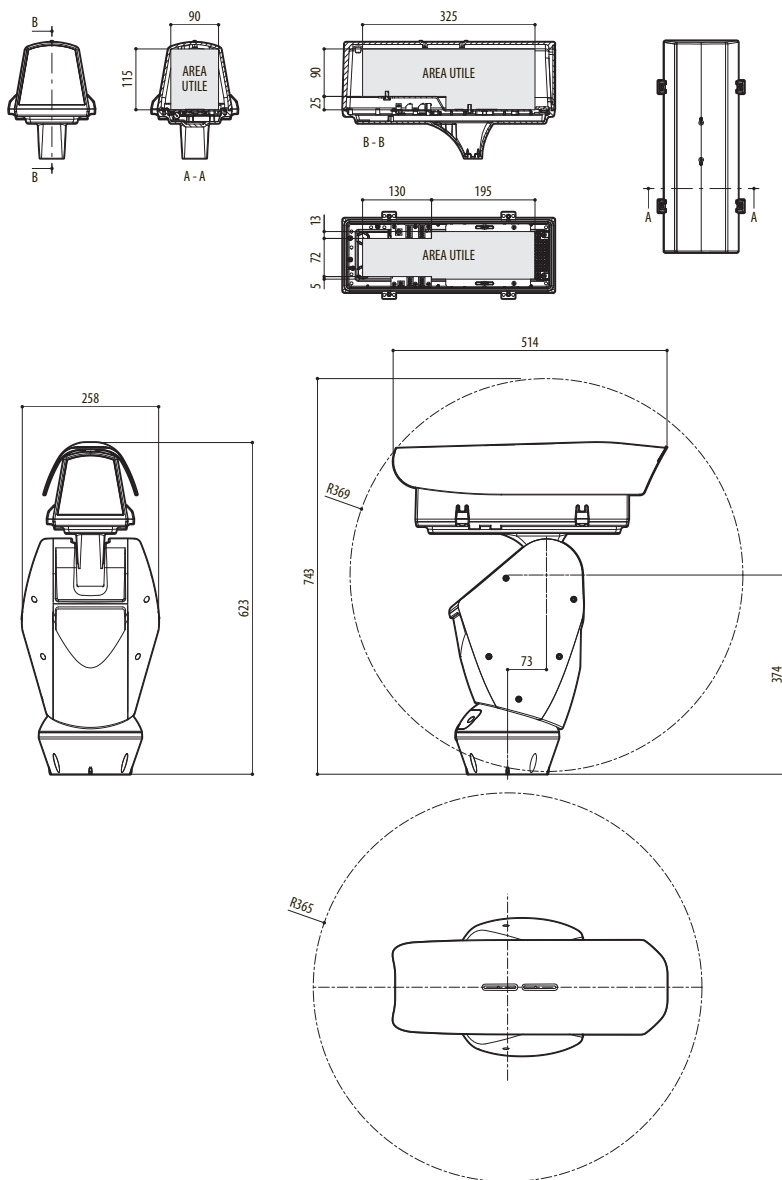

Fig. 86 ULISSE PLUS NETCAM.

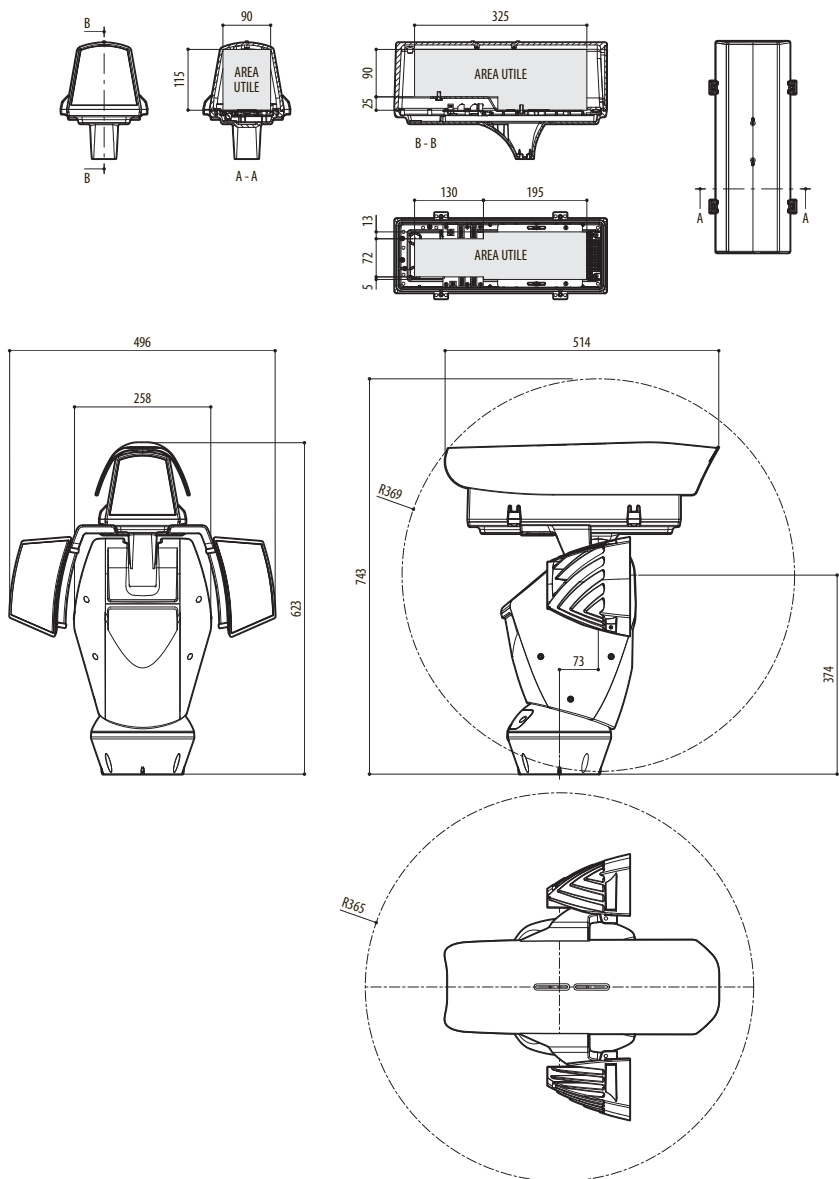

Fig. 87 ULISSE PLUS NETCAM, versione con predisposizione per il montaggio di due illuminatori a LED.

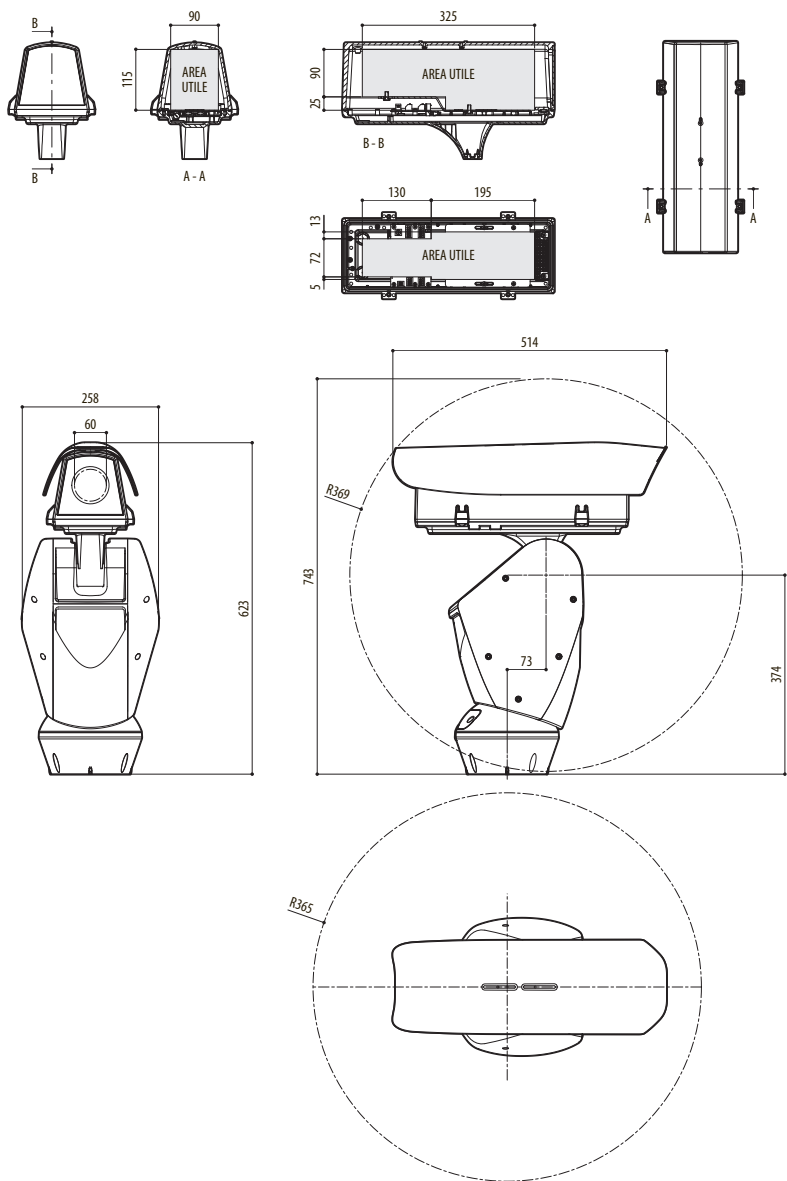

Fig. 88 ULISSE PLUS NETCAM, versione per telecamere termiche.

A Appendice - Tabella degli indirizzi



La levetta dello switch verso l'alto rappresenta il valore 1 (ON). La levetta verso il basso rappresenta il valore 0 (OFF).

Di seguito sono riportate tutte le combinazioni possibili.

CONFIGURAZIONE DELL'INDIRIZZO (DIP 3)								
SW 8	SW 7	SW 6	SW 5	SW 4	SW 3	SW 2	SW 1	Indirizzo
OFF	OFF	OFF	OFF	OFF	OFF	OFF	OFF	Indirizzo non valido
OFF	OFF	OFF	OFF	OFF	OFF	OFF	ON	Indirizzo 1
OFF	OFF	OFF	OFF	OFF	OFF	ON	OFF	Indirizzo 2
OFF	OFF	OFF	OFF	OFF	OFF	ON	ON	Indirizzo 3
OFF	OFF	OFF	OFF	OFF	ON	OFF	OFF	Indirizzo 4
OFF	OFF	OFF	OFF	OFF	ON	OFF	ON	Indirizzo 5
OFF	OFF	OFF	OFF	OFF	ON	ON	OFF	Indirizzo 6
OFF	OFF	OFF	OFF	OFF	ON	ON	ON	Indirizzo 7
OFF	OFF	OFF	OFF	ON	OFF	OFF	OFF	Indirizzo 8
OFF	OFF	OFF	OFF	ON	OFF	OFF	ON	Indirizzo 9
OFF	OFF	OFF	OFF	ON	OFF	ON	OFF	Indirizzo 10
OFF	OFF	OFF	OFF	ON	OFF	ON	ON	Indirizzo 11
OFF	OFF	OFF	OFF	ON	ON	OFF	OFF	Indirizzo 12
OFF	OFF	OFF	OFF	ON	ON	OFF	ON	Indirizzo 13
OFF	OFF	OFF	OFF	ON	ON	ON	OFF	Indirizzo 14
OFF	OFF	OFF	OFF	ON	ON	ON	ON	Indirizzo 15
OFF	OFF	OFF	ON	OFF	OFF	OFF	OFF	Indirizzo 16
OFF	OFF	OFF	ON	OFF	OFF	OFF	ON	Indirizzo 17
OFF	OFF	OFF	ON	OFF	OFF	ON	OFF	Indirizzo 18
OFF	OFF	OFF	ON	OFF	OFF	ON	ON	Indirizzo 19
OFF	OFF	OFF	ON	OFF	ON	OFF	OFF	Indirizzo 20
OFF	OFF	OFF	ON	OFF	ON	OFF	ON	Indirizzo 21
OFF	OFF	OFF	ON	OFF	ON	ON	OFF	Indirizzo 22
OFF	OFF	OFF	ON	OFF	ON	ON	ON	Indirizzo 23
OFF	OFF	OFF	ON	ON	OFF	OFF	OFF	Indirizzo 24
OFF	OFF	OFF	ON	ON	OFF	OFF	ON	Indirizzo 25
OFF	OFF	OFF	ON	ON	OFF	ON	OFF	Indirizzo 26
OFF	OFF	OFF	ON	ON	OFF	ON	ON	Indirizzo 27
OFF	OFF	OFF	ON	ON	ON	OFF	OFF	Indirizzo 28
OFF	OFF	OFF	ON	ON	ON	OFF	ON	Indirizzo 29
OFF	OFF	OFF	ON	ON	ON	ON	OFF	Indirizzo 30
OFF	OFF	OFF	ON	ON	ON	ON	ON	Indirizzo 31
OFF	OFF	ON	OFF	OFF	OFF	OFF	OFF	Indirizzo 32
OFF	OFF	ON	OFF	OFF	OFF	OFF	ON	Indirizzo 33
OFF	OFF	ON	OFF	OFF	OFF	ON	OFF	Indirizzo 34
OFF	OFF	ON	OFF	OFF	OFF	ON	ON	Indirizzo 35
OFF	OFF	ON	OFF	OFF	ON	OFF	OFF	Indirizzo 36
OFF	OFF	ON	OFF	OFF	ON	OFF	ON	Indirizzo 37
OFF	OFF	ON	OFF	OFF	ON	ON	OFF	Indirizzo 38

CONFIGURAZIONE DELL'INDIRIZZO (DIP 3)								
SW 8	SW 7	SW 6	SW 5	SW 4	SW 3	SW 2	SW 1	Indirizzo
OFF	OFF	ON	OFF	OFF	ON	ON	ON	Indirizzo 39
OFF	OFF	ON	OFF	ON	OFF	OFF	OFF	Indirizzo 40
OFF	OFF	ON	OFF	ON	OFF	OFF	ON	Indirizzo 41
OFF	OFF	ON	OFF	ON	OFF	ON	OFF	Indirizzo 42
OFF	OFF	ON	OFF	ON	OFF	ON	ON	Indirizzo 43
OFF	OFF	ON	OFF	ON	ON	OFF	OFF	Indirizzo 44
OFF	OFF	ON	OFF	ON	ON	OFF	ON	Indirizzo 45
OFF	OFF	ON	OFF	ON	ON	ON	OFF	Indirizzo 46
OFF	OFF	ON	OFF	ON	ON	ON	ON	Indirizzo 47
OFF	OFF	ON	ON	OFF	OFF	OFF	OFF	Indirizzo 48
OFF	OFF	ON	ON	OFF	OFF	OFF	ON	Indirizzo 49
OFF	OFF	ON	ON	OFF	OFF	ON	OFF	Indirizzo 50
OFF	OFF	ON	ON	OFF	OFF	ON	ON	Indirizzo 51
OFF	OFF	ON	ON	OFF	ON	OFF	OFF	Indirizzo 52
OFF	OFF	ON	ON	OFF	ON	OFF	ON	Indirizzo 53
OFF	OFF	ON	ON	OFF	ON	ON	OFF	Indirizzo 54
OFF	OFF	ON	ON	OFF	ON	ON	ON	Indirizzo 55
OFF	OFF	ON	ON	ON	OFF	OFF	OFF	Indirizzo 56
OFF	OFF	ON	ON	ON	OFF	OFF	ON	Indirizzo 57
OFF	OFF	ON	ON	ON	OFF	ON	OFF	Indirizzo 58
OFF	OFF	ON	ON	ON	OFF	ON	ON	Indirizzo 59
OFF	OFF	ON	ON	ON	ON	OFF	OFF	Indirizzo 60
OFF	OFF	ON	ON	ON	ON	OFF	ON	Indirizzo 61
OFF	OFF	ON	ON	ON	ON	ON	OFF	Indirizzo 62
OFF	OFF	ON	ON	ON	ON	ON	ON	Indirizzo 63
OFF	ON	OFF	OFF	OFF	OFF	OFF	OFF	Indirizzo 64
OFF	ON	OFF	OFF	OFF	OFF	OFF	ON	Indirizzo 65
OFF	ON	OFF	OFF	OFF	OFF	ON	OFF	Indirizzo 66
OFF	ON	OFF	OFF	OFF	OFF	ON	ON	Indirizzo 67
OFF	ON	OFF	OFF	OFF	ON	OFF	OFF	Indirizzo 68
OFF	ON	OFF	OFF	OFF	ON	OFF	ON	Indirizzo 69
OFF	ON	OFF	OFF	OFF	ON	ON	OFF	Indirizzo 70
OFF	ON	OFF	OFF	OFF	ON	ON	ON	Indirizzo 71
OFF	ON	OFF	OFF	ON	OFF	OFF	OFF	Indirizzo 72
OFF	ON	OFF	OFF	ON	OFF	OFF	ON	Indirizzo 73
OFF	ON	OFF	OFF	ON	OFF	ON	OFF	Indirizzo 74
OFF	ON	OFF	OFF	ON	OFF	ON	ON	Indirizzo 75
OFF	ON	OFF	OFF	ON	ON	OFF	OFF	Indirizzo 76
OFF	ON	OFF	OFF	ON	ON	OFF	ON	Indirizzo 77
OFF	ON	OFF	OFF	ON	ON	ON	OFF	Indirizzo 78
OFF	ON	OFF	OFF	ON	ON	ON	ON	Indirizzo 79
OFF	ON	OFF	ON	OFF	OFF	OFF	OFF	Indirizzo 80
OFF	ON	OFF	ON	OFF	OFF	OFF	ON	Indirizzo 81
OFF	ON	OFF	ON	OFF	OFF	ON	OFF	Indirizzo 82

CONFIGURAZIONE DELL'INDIRIZZO (DIP 3)								
SW 8	SW 7	SW 6	SW 5	SW 4	SW 3	SW 2	SW 1	Indirizzo
OFF	ON	OFF	ON	OFF	OFF	ON	ON	Indirizzo 83
OFF	ON	OFF	ON	OFF	ON	OFF	OFF	Indirizzo 84
OFF	ON	OFF	ON	OFF	ON	OFF	ON	Indirizzo 85
OFF	ON	OFF	ON	OFF	ON	ON	OFF	Indirizzo 86
OFF	ON	OFF	ON	OFF	ON	ON	ON	Indirizzo 87
OFF	ON	OFF	ON	ON	OFF	OFF	OFF	Indirizzo 88
OFF	ON	OFF	ON	ON	OFF	OFF	ON	Indirizzo 89
OFF	ON	OFF	ON	ON	OFF	ON	OFF	Indirizzo 90
OFF	ON	OFF	ON	ON	OFF	ON	ON	Indirizzo 91
OFF	ON	OFF	ON	ON	ON	OFF	OFF	Indirizzo 92
OFF	ON	OFF	ON	ON	ON	OFF	ON	Indirizzo 93
OFF	ON	OFF	ON	ON	ON	ON	OFF	Indirizzo 94
OFF	ON	OFF	ON	ON	ON	ON	ON	Indirizzo 95
OFF	ON	ON	OFF	OFF	OFF	OFF	OFF	Indirizzo 96
OFF	ON	ON	OFF	OFF	OFF	OFF	ON	Indirizzo 97
OFF	ON	ON	OFF	OFF	OFF	ON	OFF	Indirizzo 98
OFF	ON	ON	OFF	OFF	OFF	ON	ON	Indirizzo 99
OFF	ON	ON	OFF	OFF	ON	OFF	OFF	Indirizzo 100
OFF	ON	ON	OFF	OFF	ON	OFF	ON	Indirizzo 101
OFF	ON	ON	OFF	OFF	ON	ON	OFF	Indirizzo 102
OFF	ON	ON	OFF	OFF	ON	ON	ON	Indirizzo 103
OFF	ON	ON	OFF	ON	OFF	OFF	OFF	Indirizzo 104
OFF	ON	ON	OFF	ON	OFF	OFF	ON	Indirizzo 105
OFF	ON	ON	OFF	ON	OFF	ON	OFF	Indirizzo 106
OFF	ON	ON	OFF	ON	OFF	ON	ON	Indirizzo 107
OFF	ON	ON	OFF	ON	ON	OFF	OFF	Indirizzo 108
OFF	ON	ON	OFF	ON	ON	OFF	ON	Indirizzo 109
OFF	ON	ON	OFF	ON	ON	ON	OFF	Indirizzo 110
OFF	ON	ON	OFF	ON	ON	ON	ON	Indirizzo 111
OFF	ON	ON	ON	OFF	OFF	OFF	OFF	Indirizzo 112
OFF	ON	ON	ON	OFF	OFF	OFF	ON	Indirizzo 113
OFF	ON	ON	ON	OFF	OFF	ON	OFF	Indirizzo 114
OFF	ON	ON	ON	OFF	OFF	ON	ON	Indirizzo 115
OFF	ON	ON	ON	OFF	ON	OFF	OFF	Indirizzo 116
OFF	ON	ON	ON	OFF	ON	OFF	ON	Indirizzo 117
OFF	ON	ON	ON	OFF	ON	ON	OFF	Indirizzo 118
OFF	ON	ON	ON	OFF	ON	ON	ON	Indirizzo 119
OFF	ON	ON	ON	ON	OFF	OFF	OFF	Indirizzo 120
OFF	ON	ON	ON	ON	OFF	OFF	ON	Indirizzo 121
OFF	ON	ON	ON	ON	OFF	ON	OFF	Indirizzo 122
OFF	ON	ON	ON	ON	OFF	ON	ON	Indirizzo 123
OFF	ON	ON	ON	ON	ON	OFF	OFF	Indirizzo 124
OFF	ON	ON	ON	ON	ON	OFF	ON	Indirizzo 125
OFF	ON	ON	ON	ON	ON	ON	OFF	Indirizzo 126

CONFIGURAZIONE DELL'INDIRIZZO (DIP 3)								
SW 8	SW 7	SW 6	SW 5	SW 4	SW 3	SW 2	SW 1	Indirizzo
OFF	ON	ON	ON	ON	ON	ON	ON	Indirizzo 127
ON	OFF	OFF	OFF	OFF	OFF	OFF	OFF	Indirizzo 128
ON	OFF	OFF	OFF	OFF	OFF	OFF	ON	Indirizzo 129
ON	OFF	OFF	OFF	OFF	OFF	ON	OFF	Indirizzo 130
ON	OFF	OFF	OFF	OFF	OFF	ON	ON	Indirizzo 131
ON	OFF	OFF	OFF	OFF	ON	OFF	OFF	Indirizzo 132
ON	OFF	OFF	OFF	OFF	ON	OFF	ON	Indirizzo 133
ON	OFF	OFF	OFF	OFF	ON	ON	OFF	Indirizzo 134
ON	OFF	OFF	OFF	OFF	ON	ON	ON	Indirizzo 135
ON	OFF	OFF	OFF	ON	OFF	OFF	OFF	Indirizzo 136
ON	OFF	OFF	OFF	ON	OFF	OFF	ON	Indirizzo 137
ON	OFF	OFF	OFF	ON	OFF	ON	OFF	Indirizzo 138
ON	OFF	OFF	OFF	ON	OFF	ON	ON	Indirizzo 139
ON	OFF	OFF	OFF	ON	ON	OFF	OFF	Indirizzo 140
ON	OFF	OFF	OFF	ON	ON	OFF	ON	Indirizzo 141
ON	OFF	OFF	OFF	ON	ON	ON	OFF	Indirizzo 142
ON	OFF	OFF	OFF	ON	ON	ON	ON	Indirizzo 143
ON	OFF	OFF	ON	OFF	OFF	OFF	OFF	Indirizzo 144
ON	OFF	OFF	ON	OFF	OFF	OFF	ON	Indirizzo 145
ON	OFF	OFF	ON	OFF	OFF	ON	OFF	Indirizzo 146
ON	OFF	OFF	ON	OFF	OFF	ON	ON	Indirizzo 147
ON	OFF	OFF	ON	OFF	ON	OFF	OFF	Indirizzo 148
ON	OFF	OFF	ON	OFF	ON	OFF	ON	Indirizzo 149
ON	OFF	OFF	ON	OFF	ON	ON	OFF	Indirizzo 150
ON	OFF	OFF	ON	OFF	ON	ON	ON	Indirizzo 151
ON	OFF	OFF	ON	ON	OFF	OFF	OFF	Indirizzo 152
ON	OFF	OFF	ON	ON	OFF	OFF	ON	Indirizzo 153
ON	OFF	OFF	ON	ON	OFF	ON	OFF	Indirizzo 154
ON	OFF	OFF	ON	ON	OFF	ON	ON	Indirizzo 155
ON	OFF	OFF	ON	ON	ON	OFF	OFF	Indirizzo 156
ON	OFF	OFF	ON	ON	ON	OFF	ON	Indirizzo 157
ON	OFF	OFF	ON	ON	ON	ON	OFF	Indirizzo 158
ON	OFF	OFF	ON	ON	ON	ON	ON	Indirizzo 159
ON	OFF	ON	OFF	OFF	OFF	OFF	OFF	Indirizzo 160
ON	OFF	ON	OFF	OFF	OFF	OFF	ON	Indirizzo 161
ON	OFF	ON	OFF	OFF	OFF	ON	OFF	Indirizzo 162
ON	OFF	ON	OFF	OFF	OFF	ON	ON	Indirizzo 163
ON	OFF	ON	OFF	OFF	ON	OFF	OFF	Indirizzo 164
ON	OFF	ON	OFF	OFF	ON	OFF	ON	Indirizzo 165
ON	OFF	ON	OFF	OFF	ON	ON	OFF	Indirizzo 166
ON	OFF	ON	OFF	OFF	ON	ON	ON	Indirizzo 167
ON	OFF	ON	OFF	ON	OFF	OFF	OFF	Indirizzo 168
ON	OFF	ON	OFF	ON	OFF	OFF	ON	Indirizzo 169
ON	OFF	ON	OFF	ON	OFF	ON	OFF	Indirizzo 170

CONFIGURAZIONE DELL'INDIRIZZO (DIP 3)								
SW 8	SW 7	SW 6	SW 5	SW 4	SW 3	SW 2	SW 1	Indirizzo
ON	OFF	ON	OFF	ON	OFF	ON	ON	Indirizzo 171
ON	OFF	ON	OFF	ON	ON	OFF	OFF	Indirizzo 172
ON	OFF	ON	OFF	ON	ON	OFF	ON	Indirizzo 173
ON	OFF	ON	OFF	ON	ON	ON	OFF	Indirizzo 174
ON	OFF	ON	OFF	ON	ON	ON	ON	Indirizzo 175
ON	OFF	ON	ON	OFF	OFF	OFF	OFF	Indirizzo 176
ON	OFF	ON	ON	OFF	OFF	OFF	ON	Indirizzo 177
ON	OFF	ON	ON	OFF	OFF	ON	OFF	Indirizzo 178
ON	OFF	ON	ON	OFF	OFF	ON	ON	Indirizzo 179
ON	OFF	ON	ON	OFF	ON	OFF	OFF	Indirizzo 180
ON	OFF	ON	ON	OFF	ON	OFF	ON	Indirizzo 181
ON	OFF	ON	ON	OFF	ON	ON	OFF	Indirizzo 182
ON	OFF	ON	ON	OFF	ON	ON	ON	Indirizzo 183
ON	OFF	ON	ON	ON	OFF	OFF	OFF	Indirizzo 184
ON	OFF	ON	ON	ON	OFF	OFF	ON	Indirizzo 185
ON	OFF	ON	ON	ON	OFF	ON	OFF	Indirizzo 186
ON	OFF	ON	ON	ON	OFF	ON	ON	Indirizzo 187
ON	OFF	ON	ON	ON	ON	OFF	OFF	Indirizzo 188
ON	OFF	ON	ON	ON	ON	OFF	ON	Indirizzo 189
ON	OFF	ON	ON	ON	ON	ON	OFF	Indirizzo 190
ON	OFF	ON	ON	ON	ON	ON	ON	Indirizzo 191
ON	ON	OFF	OFF	OFF	OFF	OFF	OFF	Indirizzo 192
ON	ON	OFF	OFF	OFF	OFF	OFF	ON	Indirizzo 193
ON	ON	OFF	OFF	OFF	OFF	ON	OFF	Indirizzo 194
ON	ON	OFF	OFF	OFF	OFF	ON	ON	Indirizzo 195
ON	ON	OFF	OFF	OFF	ON	OFF	OFF	Indirizzo 196
ON	ON	OFF	OFF	OFF	ON	OFF	ON	Indirizzo 197
ON	ON	OFF	OFF	OFF	ON	ON	OFF	Indirizzo 198
ON	ON	OFF	OFF	OFF	ON	ON	ON	Indirizzo 199
ON	ON	OFF	OFF	ON	OFF	OFF	OFF	Indirizzo 200
ON	ON	OFF	OFF	ON	OFF	OFF	ON	Indirizzo 201
ON	ON	OFF	OFF	ON	OFF	ON	OFF	Indirizzo 202
ON	ON	OFF	OFF	ON	OFF	ON	ON	Indirizzo 203
ON	ON	OFF	OFF	ON	ON	OFF	OFF	Indirizzo 204
ON	ON	OFF	OFF	ON	ON	OFF	ON	Indirizzo 205
ON	ON	OFF	OFF	ON	ON	ON	OFF	Indirizzo 206
ON	ON	OFF	OFF	ON	ON	ON	ON	Indirizzo 207
ON	ON	OFF	ON	OFF	OFF	OFF	OFF	Indirizzo 208
ON	ON	OFF	ON	OFF	OFF	OFF	ON	Indirizzo 209
ON	ON	OFF	ON	OFF	OFF	ON	OFF	Indirizzo 210
ON	ON	OFF	ON	OFF	OFF	ON	ON	Indirizzo 211
ON	ON	OFF	ON	OFF	ON	OFF	OFF	Indirizzo 212
ON	ON	OFF	ON	OFF	ON	OFF	ON	Indirizzo 213
ON	ON	OFF	ON	OFF	ON	ON	OFF	Indirizzo 214

CONFIGURAZIONE DELL'INDIRIZZO (DIP 3)								
SW 8	SW 7	SW 6	SW 5	SW 4	SW 3	SW 2	SW 1	Indirizzo
ON	ON	OFF	ON	OFF	ON	ON	ON	Indirizzo 215
ON	ON	OFF	ON	ON	OFF	OFF	OFF	Indirizzo 216
ON	ON	OFF	ON	ON	OFF	OFF	ON	Indirizzo 217
ON	ON	OFF	ON	ON	OFF	ON	OFF	Indirizzo 218
ON	ON	OFF	ON	ON	OFF	ON	ON	Indirizzo 219
ON	ON	OFF	ON	ON	ON	OFF	OFF	Indirizzo 220
ON	ON	OFF	ON	ON	ON	OFF	ON	Indirizzo 221
ON	ON	OFF	ON	ON	ON	ON	OFF	Indirizzo 222
ON	ON	OFF	ON	ON	ON	ON	ON	Indirizzo 223
ON	ON	ON	OFF	OFF	OFF	OFF	OFF	Indirizzo 224
ON	ON	ON	OFF	OFF	OFF	OFF	ON	Indirizzo 225
ON	ON	ON	OFF	OFF	OFF	ON	OFF	Indirizzo 226
ON	ON	ON	OFF	OFF	OFF	ON	ON	Indirizzo 227
ON	ON	ON	OFF	OFF	ON	OFF	OFF	Indirizzo 228
ON	ON	ON	OFF	OFF	ON	OFF	ON	Indirizzo 229
ON	ON	ON	OFF	OFF	ON	ON	OFF	Indirizzo 230
ON	ON	ON	OFF	OFF	ON	ON	ON	Indirizzo 231
ON	ON	ON	OFF	ON	OFF	OFF	OFF	Indirizzo 232
ON	ON	ON	OFF	ON	OFF	OFF	ON	Indirizzo 233
ON	ON	ON	OFF	ON	OFF	ON	OFF	Indirizzo 234
ON	ON	ON	OFF	ON	OFF	ON	ON	Indirizzo 235
ON	ON	ON	OFF	ON	ON	OFF	OFF	Indirizzo 236
ON	ON	ON	OFF	ON	ON	OFF	ON	Indirizzo 237
ON	ON	ON	OFF	ON	ON	ON	OFF	Indirizzo 238
ON	ON	ON	OFF	ON	ON	ON	ON	Indirizzo 239
ON	ON	ON	ON	OFF	OFF	OFF	OFF	Indirizzo 240
ON	ON	ON	ON	OFF	OFF	OFF	ON	Indirizzo 241
ON	ON	ON	ON	OFF	OFF	ON	OFF	Indirizzo 242
ON	ON	ON	ON	OFF	OFF	ON	ON	Indirizzo 243
ON	ON	ON	ON	OFF	ON	OFF	OFF	Indirizzo 244
ON	ON	ON	ON	OFF	ON	OFF	ON	Indirizzo 245
ON	ON	ON	ON	OFF	ON	ON	OFF	Indirizzo 246
ON	ON	ON	ON	OFF	ON	ON	ON	Indirizzo 247
ON	ON	ON	ON	ON	OFF	OFF	OFF	Indirizzo 248
ON	ON	ON	ON	ON	OFF	OFF	ON	Indirizzo 249
ON	ON	ON	ON	ON	OFF	ON	OFF	Indirizzo 250
ON	ON	ON	ON	ON	OFF	ON	ON	Indirizzo 251
ON	ON	ON	ON	ON	ON	OFF	OFF	Indirizzo 252
ON	ON	ON	ON	ON	ON	OFF	ON	Indirizzo 253
ON	ON	ON	ON	ON	ON	ON	OFF	Indirizzo 254
ON	ON	ON	ON	ON	ON	ON	ON	Indirizzo 255

Tab. 16

Headquarters Italy Videotec S.p.A.

Via Friuli, 6 - I-36015 Schio (VI) - Italy

Tel. +39 0445 697411 - Fax +39 0445 697414

Email: info@videotec.com

Asia Pacific Videotec (HK) Ltd

Flat 8, 19/F. On Dak Industrial Building, No. 2-6 Wah Sing Street

Kwai Chung, New Territories - Hong Kong

Tel. +852 2333 0601 - Fax +852 2311 0026

Email: info.hk@videotec.com

France Videotec France SARL

Immeuble Le Montreal, 19bis Avenue du Québec, ZA de Courtaboeuf
91140 Villebon sur Yvette - France

Tel. +33 1 60491816 - Fax +33 1 69284736

Email: info.fr@videotec.com

Americas Videotec Security, Inc.

Gateway Industrial Park, 35 Gateway Drive, Suite 100
Plattsburgh, NY 12901 - U.S.A.

Tel. +1 518 825 0020 - Fax +1 518 825 0022

Email: info.usa@videotec.com - www.videotec.us



www.videotec.com

MNVCUPTPLUS3_1511_IT



ULISSE PLUS NETCAM

Unité PTZ Full IP extérieure pour caméras
réseau avec objectifs moyens

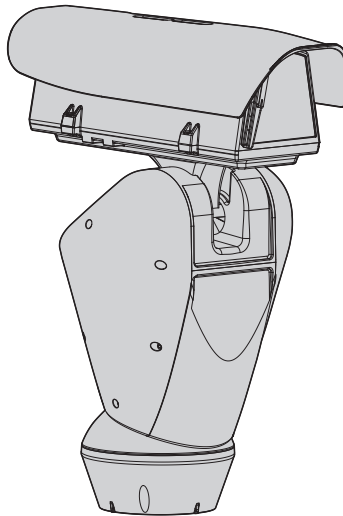

Sommaire

1 À propos de ce mode d'emploi	7
1.1 Conventions typographiques	7
2 Notes sur le copyright et informations sur les marques de commerce	7
3 Normes de sécurité.....	7
4 Identification.....	10
4.1 Description et désignation du produit	10
4.2 Marquage du produit.....	10
4.2.1 Contrôle du marquage	10
5 Versions	11
5.1 Essuie-glace intégré.....	11
5.2 Projecteurs à LED.....	11
5.3 Version avec fenêtre au germanium.....	11
6 Préparation du produit en vue de l'utilisation.....	12
6.1 Précautions de sécurité avant l'utilisation	12
6.2 Déballage.....	12
6.3 Contenu.....	12
6.4 Élimination sans danger des matériaux d'emballage.....	12
6.5 Opérations à effectuer avant l'installation.....	13
6.5.1 Fixation du support	13
6.5.2 Passage des câbles	13
7 Assemblage.....	14
7.6 Montage caméras, systèmes optiques motorisés.....	14
7.6.1 Caractéristiques des caméras.....	14
7.6.1 Ouverture du caisson.....	15
7.6.2 Installation de la caméra	15
7.7 Description de la carte du caisson.....	16
7.7.1 Branchement de la caméra et de l'optique motorisée.....	16
7.7.2 Réglage de la tension d'alimentation des moteurs des optiques.....	17
7.7.3 Branchement de la ligne de communication	17
8 Installation	18
8.1 Connexion des câbles à la base	18
8.2 Fixage de la base au support.....	19
8.3 Description de la carte de connexion	19
8.4 Connexion de la ligne d'alimentation.....	20
8.4.1 Connexion de la ligne d'alimentation en 24Vac.....	21
8.4.2 Raccordement de la ligne d'alimentation en 120Vac et 230Vac	21
8.4.3 Branchement des entrées d'alarme, de l'interrupteur crépusculaire et des relais	22
8.5 Branchement du câble de réseau Ethernet.....	22
8.6 Fixation du corps supérieur	23
8.7 Montage des projecteurs à LED	24
8.7.1 Montage de l'étrier.....	24

8.7.2 Montage du projecteur sur l'étrier	24
8.8 Branchement des projecteur à LED.....	25
8.9 Sachet déshydratant.....	26
8.10 Réglage des projecteurs à LED et modalité de synchronisation avec la caméra	26
8.10.1 Description du projecteur à LED	26
8.10.2 Synchronisation avec un interrupteur crépusculaire externe	27
8.10.3 Synchroniser l'unité avec les projecteurs LED	27
8.10.4 Activation manuelle des projecteurs à LED.....	27
8.10.5 Réglage du seuil d'allumage des projecteurs à LED.....	28
8.10.6 Réglage de la puissance des projecteurs à LED	28
8.11 Configuration du matériel.....	29
8.11.1 Ouverture du volet de configuration.....	29
8.11.2 Configuration du DIP1.....	29
8.11.3 Configuration du DIP2.....	29
8.11.4 Configuration du DIP3.....	30
8.11.4.1 Configuration de l'adresse	30
8.11.4.2 Configuration des lignes de communications sérielles	30
8.11.5 Configuration du DIP4.....	30
9 Allumage	31
10 Configuration.....	32
10.1 Interface web	32
10.1.1 Premier accès.....	32
10.1.2 Home	32
10.1.3 Contrôles Utilisateur	33
10.1.4 Paramètres Dispositif	34
10.1.5 Statistiques Dispositif	34
10.1.6 Configuration Réseau	34
10.1.7 Configuration Utilisateurs.....	35
10.1.8 Paramètres Mouvement	35
10.1.8.1 Autopan.....	36
10.1.8.2 Patrol.....	36
10.1.8.3 Rappel Mouvements.....	36
10.1.9 Paramètres Preset	36
10.1.10 Paramètres Preset (Avancé)	36
10.1.11 I/O Digitaux.....	37
10.1.12 Washer	37
10.1.13 Paramètres Caméra.....	38
10.1.14 Instruments.....	38
10.1.15 Factory Default	39
10.2 VTTunnel	39
11 Accessoires.....	40
11.1 Système de lavage	40
11.1.1 Branchement du système de lavage.....	40
11.2 Support fixation murale.....	41
11.3 Support fixation sol	41
11.4 Alimentateur avec contrôle des projecteurs.....	41
12 Instructions de fonctionnement exceptionnel	42

12.1 Modification de la modalité de communication (depuis protocole ONVIF à télémétrie sérielle)	42
12.1.1 Procédure de modification de la modalité de communication	42
13 Entretien.....	43
13.1 Remplacement des fusibles.....	43
14 Nettoyage.....	43
14.1 Entretien de la vitre et des parties en plastique.....	43
14.2 Nettoyage de la fenêtre au germanium.....	43
15 Élimination des déchets.....	43
16 Dépannage.....	44
17 Données techniques.....	45
17.1 Généralités.....	45
17.2 Mécanique	45
17.3 Électrique	46
17.4 Communications	46
17.5 Protocoles	46
17.6 Environnement	46
17.7 Certifications.....	46
18 Dessins techniques.....	47
A Annexe - Tableau des adresses.....	50

1 À propos de ce mode d'emploi

Avant d'installer et d'utiliser cet appareil, veuillez lire attentivement ce mode d'emploi. Conservez-le à portée de main pour pouvoir vous y reporter en cas de besoin.

1.1 Conventions typographiques



DANGER!

Risque élevé.

Risque de choc électrique. Sauf indication contraire, sectionner l'alimentation avant de procéder à toute opération.



DANGER!

Surface à température élevée.

Évitez le contact. La température des surfaces est élevée et leur contact peut provoquer des blessures corporelles.



DANGER!

Danger mécanique.

Risque d'écrasement ou de cisaillement.



ATTENTION!

Risque moyen.

Opération extrêmement importante en vue d'un fonctionnement correct du système; lire avec attention les opérations indiquées et s'y conformer rigoureusement.



REMARQUE

Description des caractéristiques du système.

Il est conseillé de procéder à une lecture attentive pour une meilleure compréhension des phases suivantes.

2 Notes sur le copyright et informations sur les marques de commerce

Les noms de produit ou de sociétés cités sont des marques de commerce ou des marques de commerce enregistrées.

3 Normes de sécurité



ATTENTION! Le circuit électrique auquel l'unité est reliée doit être équipé d'un interrupteur de protection bipolaire automatique de 20A max. Cet interrupteur doit être de type Listed. La distance minimale entre les contacts doit être de 3mm. L'interrupteur doit être équipé de protection contre le courant de défaut vers la terre (différentiel) et le surintensité (magnétothermique).



ATTENTION! Parties mobiles dangereux. Ne pas approcher les doigts ou d'autres parties du corps.



ATTENTION! L'installation et l'entretien du dispositif doivent être exclusivement effectués par un personnel technique qualifié.



ATTENTION! Pour assurer la protection contre le risque d'incendie, remplacer les fusibles avec le même type et valeur. Les fusibles doivent être remplacés seulement par un personnel qualifié.



ATTENTION! L'installation est du type TNV-1. Ne pas la connecter à des circuits SELV.



ATTENTION! Pour réduire les risques d'incendie, utiliser uniquement des câbles certifiés UL Listed ou CSA de dimensions égales ou supérieures à 0.13mm² (26 AWG).

- Le fabricant décline toute responsabilité pour les dommages éventuels dus à une utilisation non appropriée des appareils mentionnés dans ce manuel. On réserve en outre le droit d'en modifier le contenu sans préavis. La documentation contenue dans ce manuel a été rassemblée et vérifiée avec le plus grand soin. Le fabricant, cependant, ne peut assumer aucune responsabilité dérivant de l'emploi de celle là. La même chose vaut pour chaque personne ou société impliquées dans la création et la production de ce manuel.

- Sectionner l'alimentation avant de procéder à toute opération.
- Ne pas utiliser de câbles usés ou endommagés.
- Ne procéder sous aucun prétexte à des modifications ou des connexions non prévues dans ce manuel. L'utilisation d'appareils non adéquats peut comporter des dangers graves pour la sécurité du personnel et de l'installation.
- Utiliser uniquement des pièces de rechange d'origine. Les pièces non d'origine peuvent être source d'incendies, de choc électrique ou autres.
- Avant de procéder à l'installation, contrôler que le matériel fourni correspond à la commande et examiner les étiquettes de marquage (4.2 Marquage du produit, page 10).
- Cette appareil est conçu pour une installation permanente sur un bâtiment ou une structure adéquate. L'appareil doit être installé d'une façon permanente avant d'effectuer toute opération.
- La catégorie d'installation (ou catégorie de surtension) spécifie les niveaux de la tension de secteur correspondant à l'appareil. La catégorie dépend du lieu d'installation et du dispositif de protection contre les surtensions installé. En cas d'environnement industriel directement connecté aux circuits de dérivation du système d'alimentation, l'équipement est classé dans la catégorie d'installation III. Dans ce cas, un déclassement à la catégorie II est nécessaire et peut être obtenu au moyen d'un transformateur d'isolement avec blindage électrostatique entre le primaire et le secondaire ou en utilisant des dispositifs de protection contre les surtensions (SPD) entre la phase et le neutre et entre le neutre et la terre. Les dispositifs SPD UL cités doivent être prévus pour limiter les surtensions transitoires en mode répétitif et pour les conditions nominales de fonctionnement suivantes : Type 2 (dispositifs SPD reliés en permanence au côté charge du côté du dispositif de protection contre les surintensités) ; courant nominal de décharge (In) 20kA min. Exemples d'utilisation possible : FERRAZ SHAWMUT, ST23401PG-CN, ST240SPG-CN spécifiés pour 120Vac/240Vca, (In=20kA). La distance maximale entre installation et réduction est de 5m.
- Il faut, uniquement pour les produits marqués UL alimentés à 24Vac, utiliser un transformateur UL listed Classe 2, conforme aux normes en vigueur.
- Un dispositif de déconnexion, rapide et facile d'accès, doit être incorporé dans le circuit électrique du bâtiment pour une intervention rapide.
- La borne de terre disponible dans le produit doit être connecté en permanence à la terre.
- Raccorder le système à une source d'alimentation conforme à celle figurant sur l'étiquette de marquage du produit. Avant de procéder à l'installation, vérifier que la ligne électrique est sectionnée. La tension d'alimentation doit être comprise dans les limites ($\pm 10\%$).
- Alimenter le dispositif avec une source isolée de type SELV, 24Vac, 8A dérivée d'un transformateur à double isolation UL Listed, opportunément protégé à la sortie.
- Les parties mobiles du système représentant un risque potentiel d'accident, le système doit être installé de façon à en empêcher l'accès aux personnes non autorisées.
- Appliquer l'étiquette Parties mobiles dangereuses près de l'unité. (Fig. 5, page 12).
- Ne pas utiliser l'appareil en présence de substances inflammables.
- Pour raccorder la ligne d'alimentation utiliser le boîtier de connexion spécifique (UPTJBUL). Pour plus d'informations, se référer au manuel d'utilisation et d'installation du produit.

- Ne pas laisser l'appareil à portée des enfants ou de personnes non autorisées.
- L'appareil ne doit être considéré comme désactivé qu'avec l'alimentation sectionnée et les câbles de connexion aux autres dispositifs débranchés.
- L'entretien du dispositif doit uniquement être effectué par un personnel qualifié. Durant les opérations d'entretien, l'opérateur est exposé au risque d'électrocution ou autres.
- Utiliser uniquement les accessoires indiqués par le fabricant. Toute modification non approuvée expressément par le fabricant entraînera l'annulation de la garantie.
- Avant de brancher tous les câbles de signalisation, vérifier que l'unité est correctement branché à la terre.
- En cas de transfert du dispositif de l'installation, toujours débrancher le câble de terre en dernier.
- Adopter les précautions utiles pour éviter d'endommager l'appareil à la suite de décharges électrostatiques.
- L'unité a été réalisée pour un branchement avec câble tri-polaire. Se conformer aux indications fournies dans ce manuel pour un branchement correct du circuit de terre.
- Manipuler avec soin l'unité, toute sollicitation mécanique importante risque de l'endommager.
- Accorder une attention particulière aux distances d'isolement entre la ligne d'alimentation et tous les autres câbles, dispositifs de protection contre la foudre compris.
- En cas de transport du dispositif, faire preuve d'une attention extrême. Tout arrêt brusque, dénivellations et chocs violents risque de l'endommager et d'entraîner des blessures.

4 Identification

4.1 Description et désignation du produit

ULISSE PLUS NETCAM est un PTZ Full-IP puissant pour des applications en extérieur de vidéosurveillance IP, en mesure de gérer les caméras modernes IP SD, HD et Megapixel, et s'intégrant dans un système de réseau social.

Ce modèle peut contenir des caméras avec des objectifs de dimensions moyennes, permettant la surveillance dynamique et non-stop de grands espaces extérieurs à 360°.

La particularité d'ULISSE PLUS NETCAM est la possibilité de contrôler facilement, par réseau, toutes les fonctions de la caméra et de la tourelle, y compris l'essuie-glace, la définition et la mise en place, en utilisant les VMS les plus répandus sur le marché. Il est possible d'utiliser n'importe quelle caméra compatible ONVIF Profil S ou bien protocole propriétaire sur RS-485, alors que toute la gestion du système ne requière qu'une adresse IP.

L'unité est équipée d'un essuie-glace pour le nettoyage de la vitre avant, de la pluie et de la poussière ; un vaste choix de jerrycans est disponible avec pompe lave-glace ayant des capacités et des hauteurs manométriques différentes.

Pour garantir des images détaillées, même pendant la nuit, les versions avec des projecteurs à LED sont disponibles, avec lumière infrarouge ou lumière blanche.

La fabrication soignée top-mount permet la vision au-delà de l'horizon et la rotation continue sur l'axe horizontal et associe une vitesse élevée à une précision de mise au point absolue, aussi bien en manuel qu'en fonction de patrouille.

L'unité est équipé de senseurs optiques qui assurent le contrôle précis de la position dans n'importe quelle condition d'utilisation.

4.2 Marquage du produit



Les tourelles portent un étiquette conforme au marquage CE.

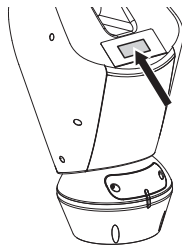

Fig. 1

L'étiquette indique:

- Code d'identification du modèle (Code barres Extended 3/9).
- Tension d'alimentation (Volt).
- Fréquence (Hertz).
- Courant absorbé (Ampères).
- Étanchéité (IP).
- Numéro de série.

4.2.1 Contrôle du marquage

Avant de procéder à l'installation, contrôler que le matériel fourni correspond à la commande et examiner les étiquettes de marquage.

Ne procéder sous aucun prétexte à des modifications ou des connexions non prévues dans ce manuel. L'utilisation d'appareils non adéquats peut comporter des dangers graves pour la sécurité du personnel et de l'installation.

5 Versions

5.1 Essuie-glace intégré

Le produit peut être équipé d'un essuie-glace.

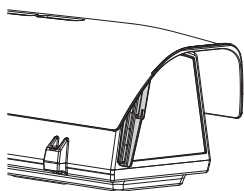

Fig. 2

i Pour d'autres renseignements se référer à le chapitre relatif (10.1.3 Contrôles Utilisateur, page 33).

La tourelle peut être équipée d'une pompe extérieure qui fournit de l'eau pour le nettoyage de la vitre.

i Pour d'autres renseignements se référer à le chapitre relatif (11.1 Système de lavage, page 40).

5.2 Projecteurs à LED

! La version avec projecteurs à LED peut être alimentée uniquement en 24Vac.

La tourelle peut être munie d'un support pour l'utilisation de 2 projecteurs à LED VIDEOTEC pour vision nocturne (projecteurs à prévoir en plus).

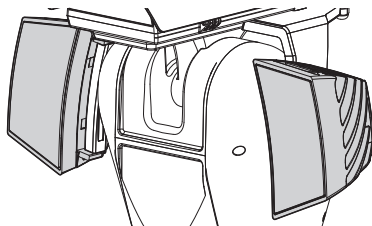

Fig. 3

i Pour d'autres renseignements se référer à le chapitre relatif (8.7 Montage des projecteurs à LED, page 24).

5.3 Version avec fenêtre au germanium

La version équipé d'une fenêtre au germanium, est prévue pour protéger les caméras thermiques des agressions climatiques extérieures.

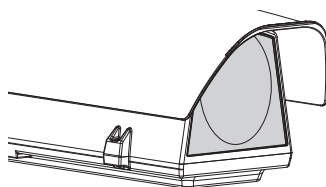



Fig. 4

6 Préparation du produit en vue de l'utilisation

 **Toute modification non approuvée expressément par le fabricant entraînera l'annulation de la garantie.**

 **L'unité ne doit être ni démontée ni altérée. Les seules exceptions concernent les opérations de montage et d'entretien prévues dans ce manuel.**

6.1 Précautions de sécurité avant l'utilisation

 **L'appareil comprend des parties mobiles. S'assurer que l'unité est positionnée dans une zone non accessible pendant le fonctionnement. Appliquer l'étiquette fournie avec l'appareil près de l'objet et en position visible.**



Fig. 5

6.2 Déballage

Lors de la livraison du produit, vérifier que l'emballage est en bon état et l'absence de tout signe évident de chute ou d'abrasion.

En cas de dommages évidents, contacter immédiatement le fournisseur.

Conserver l'emballage en cas de nécessité d'expédition du produit pour réparation.

 **Déballer le toit pare-soleil du dispositif en ayant soin de ne pas endommager le caisson.**

6.3 Contenu

Contrôler que le contenu correspond à la liste matériel indiquée ci-dessous:

- Unité de positionnement
- Base d'alimentation
- Emballage des accessoires:
 - Adaptateur sériel
 - Rallonge sérielle
 - Clés Allen
 - Entretoises (pas présents dans la version avec caméra intégrée)
 - Étiquette
 - Colliers
 - Gaine en silicone
 - Joints de réduction pour presse-étoupes
 - Manuel d'instructions
 - Plaque de fixation pour sachet déshydratant (pas présent dans les versions avec projecteurs à LED)
 - Sachet déshydratant
 - Vis
- Étrier pour la fixation des projecteur à LED (présent dans les versions avec projecteurs à LED)
- Double toit

6.4 Élimination sans danger des matériaux d'emballage

Le matériel d'emballage est entièrement composé de matériaux recyclables. Le technicien chargé de l'installation est tenu de l'éliminer conformément aux dispositions en matière de collecte sélective et selon les normes en vigueur dans le pays d'utilisation.

En cas de retour du produit défectueux, il est conseillé d'utiliser l'emballage original pour le transport.

6.5 Opérations à effectuer avant l'installation

6.5.1 Fixation du support

Plusieurs types de supports sont disponibles (11 Accessoires, page 40). Choisir le support convenable à l'installation et suivre toutes les instructions dans le chapitre suggéré.

⚠ Accorder une attention particulière aux systèmes de fixation de l'appareil. Le système de fixation doit être tout de même être en mesure de supporter au moins 4 fois le poids de tout l'appareil, y compris la tourelle, les objectifs et les caméras.

⚠ L'appareil doit être monté en position verticale. Tout autre position compromettrait le bon fonctionnement du système.

⚠ Il est impératif de ne pas monter la tête en bas.

6.5.2 Passage des câbles

⚠ Les câbles de connexion ne doivent pas être accessibles de l'extérieur. Les câbles doivent être fixés au support pour éviter que le poids excessif n'entraîne leur sortie accidentelle.

⚠ Les câbles utilisés doivent être conformes au type d'installation.

Passer les câbles à l'intérieur du support jusqu'à ce qu'ils dépassent d'environ 50cm.

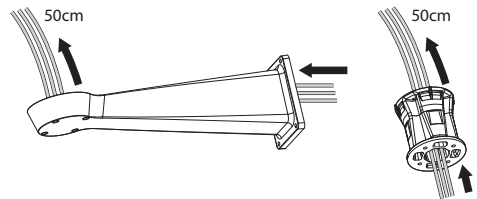

Fig. 6

7 Assemblage



Seules les caméras de réseau ayant des caractéristiques techniques déterminées peuvent être installées (7.6.1 Caractéristiques des caméras, page 14).

7.6 Montage caméras, systèmes optiques motorisés



Le bon fonctionnement de l'unité, à l'intérieur de l'intervalle de température indiqué, est garanti uniquement si la caméra et le système optique sont utilisés avec un intervalle de température égal à min. -10°C et + 60°C.

Le montage de la caméra et des objectifs correspondants est laissé aux soins du client.

7.6.1 Caractéristiques des caméras



Le bon fonctionnement de l'unité, à l'intérieur de l'intervalle de température indiqué, est garanti uniquement si la caméra et le système optique sont utilisés avec un intervalle de température égal à min. -10°C et + 60°C.



La caméra doit être préconfigurée pour acquérir l'adresse IP par DHCP.



La caméra doit être préconfigurée pour communiquer avec le serveur NTP par DHCP. Si la configuration NTP par DHCP n'est pas possible, configurer l'adresse statique suivante du serveur NTP : 192.0.0.1.



Seules des caméras de réseaux peuvent être installées dans l'unité.

- On peut monter seulement des caméras avec porte de communication Ethernet de type 100 baseTx.
- Seulement des caméras qui prévoient l'alimentation à travers une borne peuvent être installées. La tourelle n'est pas en mesure de fournir d'alimentation directement sur le câble Ethernet (Power over Ethernet).
- La tension d'alimentation de la caméra doit être de 12Vdc.
- Le courant maximum absorbé par la caméra doit être inférieur à 800mA.
- Le protocole de communication doit être ONVIF, profil S. La caméra doit être préconfigurée pour communiquer par le protocole ONVIF, profil S.
- La caméra doit pouvoir fonctionner correctement comprise entre -10°C et +60°C.

7.6.1 Ouverture du caisson

Pour ouvrir le caisson, dévisser les vis placées sur les côtés et soulever le corps supérieur.

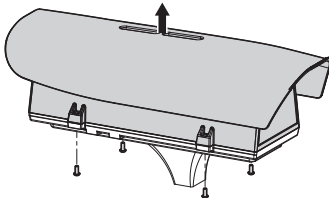

Fig. 7



Après avoir enlevé la partie supérieure du caisson l'accompagner jusqu'à ce que le câble d'ancrage soit tendu. Ne laisser pas tomber la partie supérieure du caisson, le poids pourrait casser le câble.



Au terme des opérations d'installation et de câblage, refermer le produit.

7.6.2 Installation de la caméra

Extraire la glissière interne d'appui (01) en desserrant les vis de fixation (02). Fixer la caméra avec la vis de 1/4" (03). Régler la glissière interne pour positionner correctement le système optique et la caméra.

Fixer la glissière réglable en position correcte au moyen de les vis prévues. Pour le positionnement de la caméra, utiliser les entretoises fournies (04).

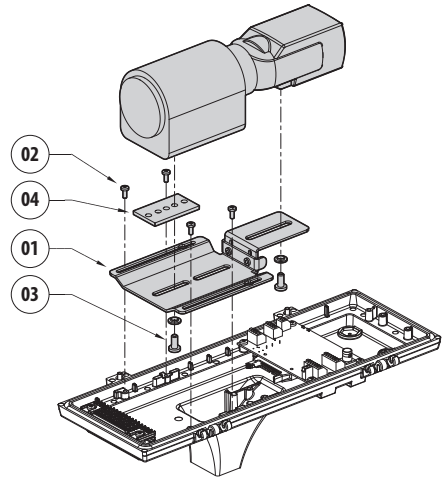

Fig. 8

Replacer la glissière interne en serrant les vis précédemment desserrées.

7.7 Description de la carte du caisson

DESCRIPTION DE LA CARTE	
Connecteur/Borne	Fonction
CN1	Non utilisé
CN2	Connecteur contrôle moteurs optiques motorisées
CN3	Connecteur potentiomètres optiques motorisées
CN6	Non utilisé
CN7	Alimentation caméra, lignes additionnelles
DIP1	Configuration de la tension d'alimentation des optiques

Tab. 1

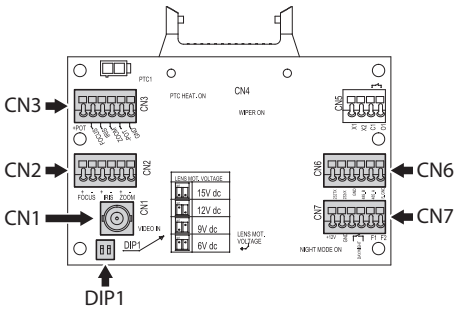

Fig. 9

7.7.1 Branchement de la caméra et de l'optique motorisée

⚠ Tous les branchements illustrés ci-après doivent exclusivement être exécutés par des installateurs experts et toutes les spécifications de câblage et d'alimentation des dispositifs doivent être respectées.

La carte électronique est prévue pour contrôler les caméras avec optiques motorisées (Focus, Iris, Zoom), éventuellement équipées de potentiomètres pour le contrôle de la position atteinte.

Avant de procéder aux branchements, vérifier que les tensions fournies par la carte sont dans les limites prévues pour l'appareil.

CONNECTEUR CAMÉRA/OPTIQUES MOTORISÉES

Tension	Courant	Description
+12V	800mA max	Alimentation caméra
+5V	15mA max	Alimentation potentiomètres optiques
De 6Vdc jusqu'à 15Vdc (réglable)	200mA max (Focus+Zoom+Iris)	Alimentation moteurs optiques

Tab. 2

Objectifs avec moteurs à fil commun: Effectuer les connexions comme montré sur la figure..

Pour l'alimentation de la caméra, effectuer les branchements comme illustré en figure.

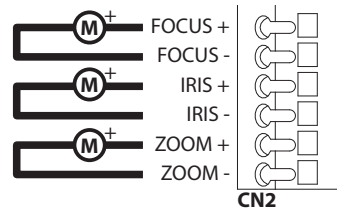

Fig. 10 CN2.

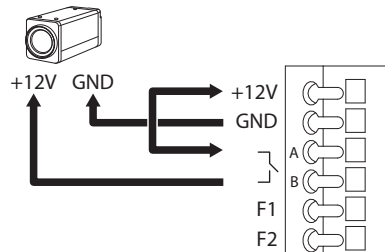

Fig. 11 CN7.

Objectifs avec moteurs à inversion de polarité:
Effectuer les connexions comme montré sur la figure..

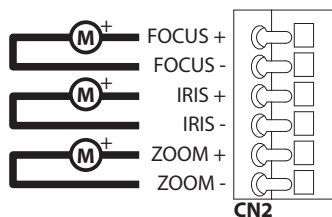

Fig. 12 CN2.

Objectifs avec moteurs à fil commun: Activer la fonction relative dans le menu (10.1.13 Paramètres Caméra, page 38). Effectuer les connexions comme montré sur la figure..

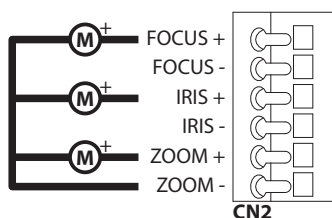

Fig. 13 CN2.

Potentimètres: Effectuer les connexions comme montré sur la figure..

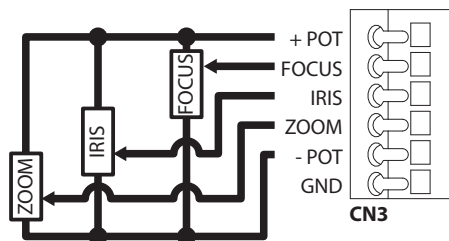

Fig. 14 CN3.

7.7.2 Réglage de la tension d'alimentation des moteurs des optiques

Avant d'alimenter la tourelle, sélectionner la tension d'alimentation des optiques en agissant sur le DIP1 (7.7 Description de la carte du caisson, page 16).

RÉGLAGE DE LA TENSION D'ALIMENTATION DES MOTEURS DES OPTIQUES

SW1	SW2	Tension
OFF	OFF	15Vdc
ON	OFF	12Vdc
OFF	ON	9Vdc
ON	ON	6Vdc

Tab. 3

7.7.3 Branchement de la ligne de communication

Brancher le câble Ethernet à la caméra.

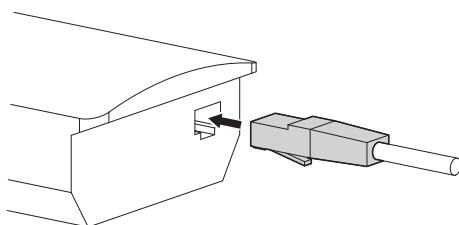

Fig. 15

i Regrouper le câble en excès pour éviter les interférences avec le fonctionnement de l'essuie-glace (dans les versions qui en sont équipées).

8 Installation



Ne procéder sous aucun prétexte à des modifications ou des connexions non prévues dans ce manuel. L'utilisation d'appareils inadéquats peut comporter des risques sérieux pour les appareils et la sécurité du personnel.



Ne pas modifier les câblages du produit. La non observation de cette indication peut entraîner des risques graves pour la sécurité du personnel de l'installation et annuler la garantie.



En cas d'utilisation du kit de lavage du verre, le support pour la buse doit être installé avant le positionnement de la tourelle et des câblages. Pour plus d'informations, se référer au manuel du kit correspondant.

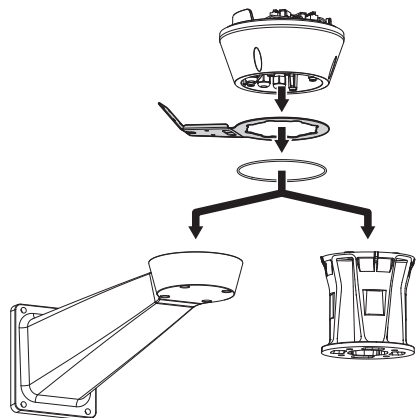

Fig. 16



La calotte inférieure contient un sachet déshydratant qui permet d'éviter la formation d'humidité dans la base et à hauteur des cartes des connecteurs. Enlever le sachet avant l'installation.

8.1 Connexion des câbles à la base

Passer les câbles dans les presse-câbles en maintenant la base à environ 20cm du support. Serrer les presse-étoupes. Les presse-étoupes sont adaptés pour câbles avec un diamètre compris entre 5mm et 10mm.

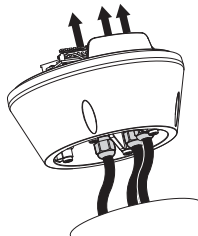

Fig. 17



Faire attention pendant la fixation. Couple de serrage: 5Nm.



Pour de cables de diamètre de 3mm à 7mm utiliser les joints en dotation.

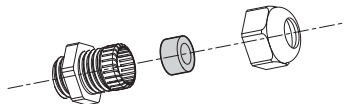

Fig. 18

8.2 Fixage de la base au support

⚠ Utiliser les vis et les rondelles fournies avec la base.

Après avoir positionné le joint (01), fixer la base (02) au support (03) en utilisant les vis (04), les rondelles à dents (05) et les bagues pour vis (06).

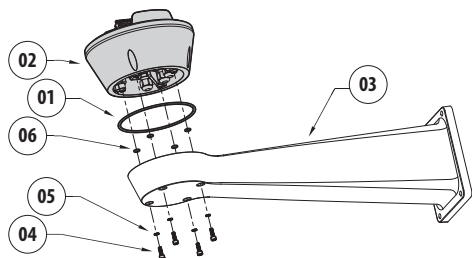

Fig. 19

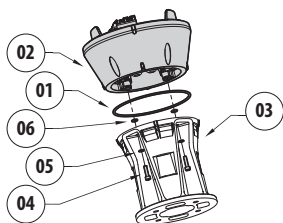

Fig. 20

Aligner les 3 encoches de la base avec celles des supports comme sur la figure suivante.

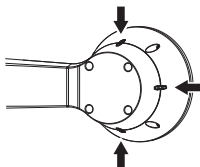

Fig. 21

⚠ Appliquer sur les trous des vis un produit de freinage du filet (Loctite 243®).

⚠ Faire attention pendant la fixation. Couple de serrage: 4Nm.

8.3 Description de la carte de connexion

DESCRIPTION DE LA CARTE DE CONNEXION

Connecteur/Composant	Fonction
CN1	Alimentation de la carte
CN4	Câbles de signal
Ethernet	Ethernet
F1	Fusible
F2	Fusible

Tab. 4

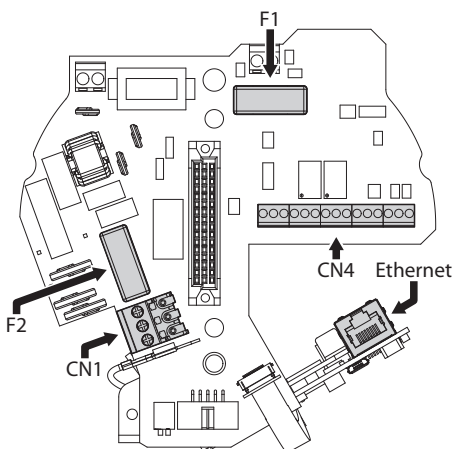



Fig. 22

8.4 Connexion de la ligne d'alimentation

Selon la version, différentes tensions d'alimentation peuvent être fournies au dispositif. Leur valeur est indiquée sur l'étiquette d'identification du produit (4.2 Marquage du produit, page 10).

 **Il faut effectuer les connexions électriques en absence d'alimentation et lorsque le dispositif de sectionnement ouvert.**

 **Contrôler que les sources d'alimentation et les câbles de branchement sont en mesure de supporter la consommation du système.**

 **Procéder exclusivement aux connexions de la base avec l'alimentation sectionnée et le dispositif de sectionnement ouvert.**

 **Le câble de terre doit être plus long des deux autres d'environ 10mm pour éviter tout détachement accidentel.**

 **Le câble d'alimentation doit en outre être couvert de la gaine en silicone (01) fournie. La gaine en silicone doit être fixée au moyen du collier prévu (02).**

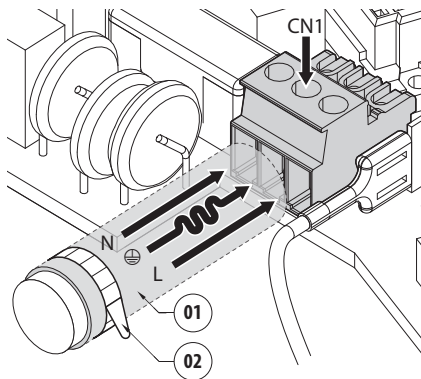

Fig. 23

8.4.1 Connexion de la ligne d'alimentation en 24Vac

⚠ Il faut, uniquement pour les produits marqués UL alimentés à 24Vac, utiliser un transformateur UL listed Classe 2, conforme aux normes en vigueur.

Couper les câbles à la longueur nécessaire et procéder aux connexions. Connecter la ligne d'alimentation avec la borne: CN1.

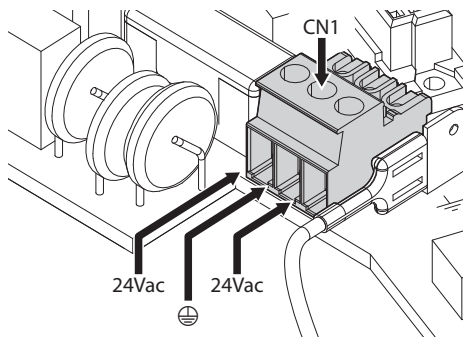

Fig. 24

Connecter les câbles d'alimentation comme décrit dans le tableau ci-dessous.

CONNEXION DE LA LIGNE D'ALIMENTATION	
Couleur	Bornes
Alimentation 24Vac	
Défini par l'installateur	24Vac
Défini par l'installateur	24Vac
Jaune/Vert	⊕

Tab. 5

8.4.2 Raccordement de la ligne d'alimentation en 120Vac et 230Vac

Couper les câbles à la longueur nécessaire et procéder aux connexions. Connecter la ligne d'alimentation avec la borne: CN1.

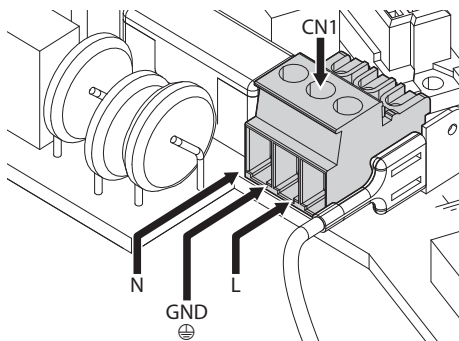

Fig. 25

Connecter les câbles d'alimentation comme décrit dans le tableau ci-dessous.

CONNEXION DE LA LIGNE D'ALIMENTATION	
Couleur	Bornes
Alimentation 230Vac	
Bleue	N (Neutre)
Marron	L (Phase)
Jaune/Vert	⊕
Alimentation 120Vac	
Bleue	N (Neutre)
Marron	L (Phase)
Jaune/Vert	⊕

Tab. 6

8.4.3 Branchement des entrées d'alarme, de l'interrupteur crépusculaire et des relais



ATTENTION! L'installation est du type TNV-1. Ne pas la connecter à des circuits SELV.



ATTENTION! Pour réduire les risques d'incendie, utiliser uniquement des câbles certifiés UL Listed ou CSA de dimensions égales ou supérieures à 0.13mm² (26 AWG).

Version standard

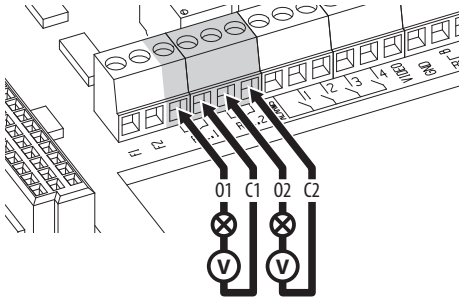

Fig. 26 Branchement des contacts des relais.

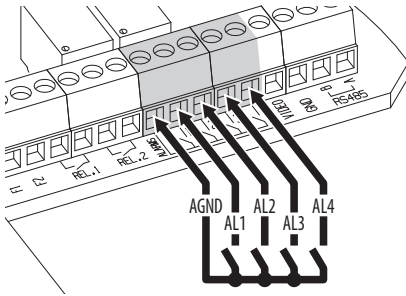

Fig. 27 Branchement des alarmes.

Version avec projecteurs à LED

BRANCHEMENT DES ENTRÉES D'ALARME, DE L'INTERRUPTEUR CRÉPUSCULAIRE ET DES RELAIS

AL1, AL2, AL3, AL4 e AGND	Entrées d'alarme auto-alimentées relatives à la borne commune AGND.
O1-C1 e O2-C2	Contacts secs de sortie activantes par alarme ou commande utilisateur

Tab. 7



Relier l'interrupteur crépusculaire aux bornes AGND et AL1. Le contact d'alarme AL1 est dédié par défaut à l'interrupteur crépusculaire.

8.5 Branchement du câble de réseau Ethernet

Connecter le câble Ethernet avec le connecteur (8.3 Description de la carte de connexion, page 19).

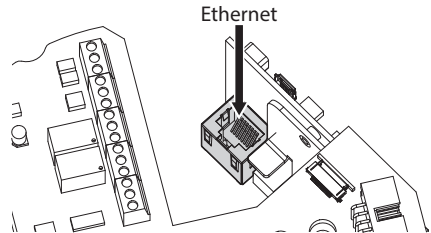



Fig. 28

8.6 Fixation du corps supérieur

Fixer le corps supérieur (01) à la base (02) au moyen des vis de fixation (03) pourvues de joints (04). Contrôler que le joint de la base est en place et en bon état (05).

 **Faire attention pendant la fixation. Couple de serrage: 4Nm.**

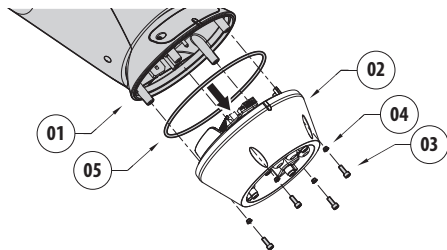

Fig. 29

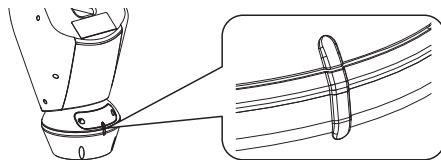



Fig. 30

 **Une seule position de fixation entre la base et le corps supérieur est possible. Aligner les saillies latérales pour s'assurer que le positionnement soit correct.**

8.7 Montage des projecteurs à LED



Pour un correct fonctionnement les deux projecteurs doivent toujours être montés ensemble.



Seuls des projecteurs VIDEOTEC peuvent être installés sur la tourelle.

8.7.1 Montage de l'étrier

Positionner l'étrier (01) sur la partie inférieure du caisson comme illustré en figure. Introduire les vis et les rondelles (02) dans les trous (03) et les serrer. Vérifier la solidité de la fixation. Ne pas utiliser de matériel non fourni dans le kit.

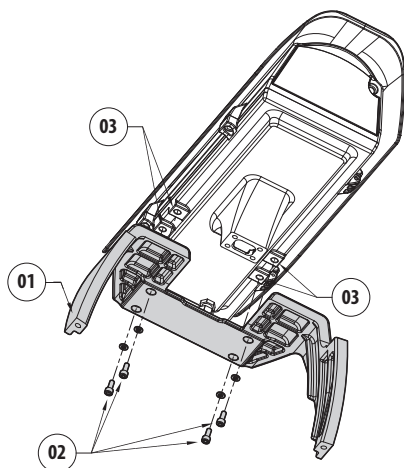

Fig. 31



Faire attention pendant la fixation. Couple de serrage: 4Nm.

8.7.2 Montage du projecteur sur l'étrier

Positionner les fixations du projecteur (01) sur celles de l'étrier (02).

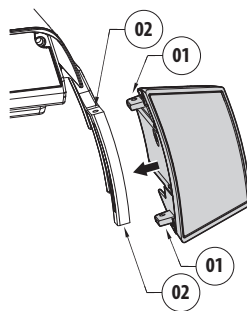

Fig. 32

Visser les vis avec les rondelles enlevées auparavant.

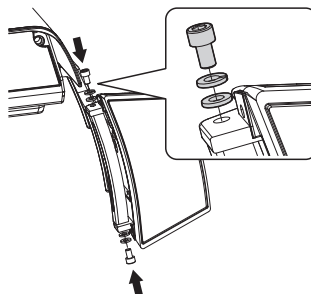

Fig. 33



Faire attention pendant la fixation. Couple de serrage: 6Nm.

8.8 Branchement des projecteur à LED

Ouvrir le caisson comme décrit (Fig. 7, page 15).
Introduire les câbles d'alimentation de 25 cm au moins à travers les presse-étoupes.

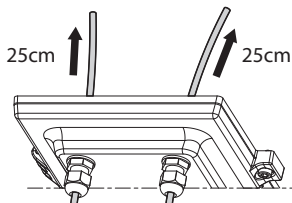
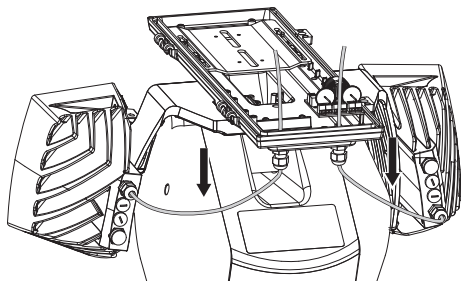

Fig. 34

⚠ Pour garantir la sécurité et le fonctionnement de l'unité, ne pas laisser de câble excédentaire à l'extérieur.



Brancher les câbles comme illustré en figure.

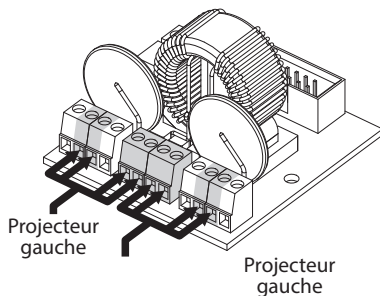

Fig. 35

BRANCHEMENT DES PROJECTEUR À LED			
Projecteur gauche		Projecteur gauche	
Référence sur la carte	Couleur du câble	Référence sur la carte	Couleur du câble
WH	Blanc	WH	Blanc
BK	Noir	BK	Noir
A1	Vert	A2	Vert
B1	Rouge	B2	Rouge

Tab. 8

8.9 Sachet déshydratant

Fixer le sachet déshydratant au moyen de la bride prévue.

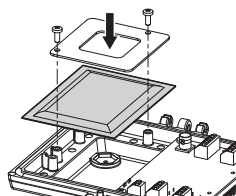

Fig. 36

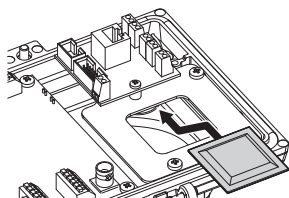

Fig. 37 Présent dans les versions avec projecteurs à LED.

8.10 Reglage des projecteurs à LED et modalité de synchronisation avec la caméra



Une fois effectué le réglage, le projecteur de gauche (MASTER) synchronise et contrôle le projecteur de droite (SLAVE).

L'interrupteur crépusculaire détecte la lumière ambiante et gère l'allumage et l'extinction des projecteurs lorsque la luminosité atteint le niveau réglé par l'utilisateur.

Lorsque les projecteurs à LED sont actifs, la caméra passe en mode nuit par la commande ONVIF prévue à cet effet.

8.10.1 Description du projecteur à LED



Pour ne pas compromettre la sécurité et le fonctionnement du projecteur, ne pas enlever la vis transparente du capteur crépusculaire.

- **Capteur crépusculaire:** Détecte le niveau de luminosité.
- **Câble:** Alimentation et contrôle.
- **Régulateur du seuil d'allumage:** Le potentiomètre permet de régler le niveau de sensibilité pour l'allumage du projecteur.
- **Régulateur puissance infrarouges:** Le potentiomètre permet de régler la puissance du projecteur.

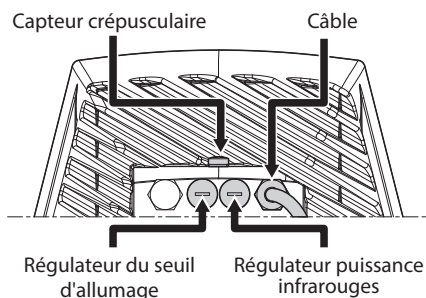

Fig. 38

8.10.2 Synchronisation avec un interrupteur crépusculaire externe

Pour synchroniser les illuminateurs et la caméra avec un crépusculaire externe, procéder comme suit:

- Relier l'interrupteur crépusculaire aux bornes: AL1/AGND (8.4.3 Branchement des entrées d'alarme, de l'interrupteur crépusculaire et des relais, page 22).
- Régler le projecteur gauche (MASTER):
 - **Seuil d'allumage:** Configurer la valeur sur OFF (8.10.5 Réglage du seuil d'allumage des projecteurs à LED, page 28).
 - **Puissance des infrarouges:** Configurer la valeur selon la nécessité (8.10.6 Réglage de la puissance des projecteurs à LED, page 28).
- Réglage du projecteur de droite (SLAVE):
 - **Seuil d'allumage:** Configurer la valeur au maximum (8.10.5 Réglage du seuil d'allumage des projecteurs à LED, page 28).
 - **Puissance des infrarouges:** Configurer la valeur au minimum (8.10.6 Réglage de la puissance des projecteurs à LED, page 28).

Depuis la rubrique Sonde IR, sélectionner l'option Externe (10.1.13 Paramètres Caméra, page 38).

Dans la carte I/O Numériques, configurer les valeurs de la façon suivante (10.1.11 I/O Numériques, page 37):

- **ID Alarme:** 1
- **Type:** NORMALEMENT OUVERT
- **Action:** IR_FILTER

8.10.3 Synchroniser l'unité avec les projecteurs LED

Pour synchroniser l'unité avec les projecteurs à LED, procéder comme suit:

- Régler le projecteur gauche (MASTER):
 - **Seuil d'allumage:** Configurer la valeur selon la nécessité (8.10.5 Réglage du seuil d'allumage des projecteurs à LED, page 28).
 - **Puissance des infrarouges:** Configurer la valeur selon la nécessité (8.10.6 Réglage de la puissance des projecteurs à LED, page 28).

- Réglage du projecteur de droite (SLAVE):
 - **Seuil d'allumage:** Configurer la valeur au maximum (8.10.5 Réglage du seuil d'allumage des projecteurs à LED, page 28).
 - **Puissance des infrarouges:** Configurer la valeur au minimum (8.10.6 Réglage de la puissance des projecteurs à LED, page 28).

Depuis la rubrique Paramètres Chambre, sélectionner l'option Interne (10.1.13 Paramètres Caméra, page 38).

8.10.4 Activation manuelle des projecteurs à LED

Si on souhaite activer le projecteur à LED, il faut :

- Régler le projecteur gauche (MASTER):
 - **Seuil d'allumage:** Configurer la valeur sur OFF (8.10.5 Réglage du seuil d'allumage des projecteurs à LED, page 28).
 - **Puissance des infrarouges:** Configurer la valeur selon la nécessité (8.10.6 Réglage de la puissance des projecteurs à LED, page 28).
- Réglage du projecteur de droite (SLAVE):
 - **Seuil d'allumage:** Configurer la valeur au maximum (8.10.5 Réglage du seuil d'allumage des projecteurs à LED, page 28).
 - **Puissance des infrarouges:** Configurer la valeur au minimum (8.10.6 Réglage de la puissance des projecteurs à LED, page 28).

8.10.5 Réglage du seuil d'allumage des projecteurs à LED

! Le projecteur de droite doit toujours être configuré à la luminosité maximum.

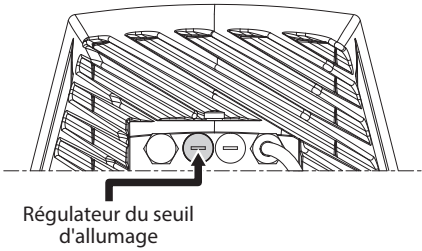

Fig. 39

Le projecteur a un capteur crépusculaire intégrée qui permet un allumage et un arrêt automatique à conditions lumineuses préétablies.

Le réglage du capteur crépusculaire est effectué en usine à un niveau lumineux fixé et approprié à la plupart des installations (environ 50lx). Si l'on souhaite régler différemment le seuil d'intervention, dévisser le bouchon situé à l'arrière du projecteur et effectuer le réglage avec un tournevis.

En tournant le bouton de réglage dans le sens des aiguilles d'une montre, la commutation en mode nocturne est avancée (à une valeur de luminosité supérieure.) En tournant le bouton de réglage dans le sens inverse des aiguilles d'une montre, la commutation en mode nocturne est retardée (à une valeur de luminosité inférieure.)

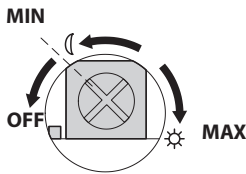

Fig. 40

Attendre les conditions de luminosité appropriées pour allumer le projecteur. Tourner lentement le trimmer jusqu'à ce que la LED présente sur le côté s'allume. Une fois que le seuil d'intervention (LED allumée) est dépassé, tourner légèrement dans le sens contraire.

! Au terme des réglages, vérifier que le bouchon de fermeture soit bien serré pour garantir l'étanchéité hermétique du produit.

8.10.6 Réglage de la puissance des projecteurs à LED

! Le projecteur de droite doit toujours être configuré à la puissance minimum.

i Le projecteur est réglé en usine afin de distribuer la puissance maximale. Если вы не служите, чтобы осветить далекие детали или изображение получается засвеченным из-за избыточной освещенности, отрегулируйте мощность, чтобы ее уменьшить и получить энергосбережение.

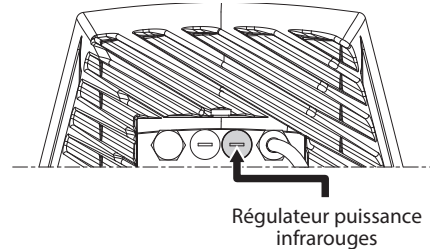

Fig. 41

Dévisser tout d'abord le bouchon de fermeture hermétique. Tourner le trimmer, dans le sens horaire pour augmenter la puissance des infrarouges et dans le sens antihoraire pour l'abaisser.

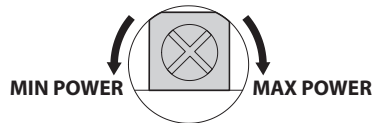

Fig. 42

! Au terme des réglages, vérifier que le bouchon de fermeture soit bien serré pour garantir l'étanchéité hermétique du produit.

8.11 Configuration du matériel

i La configuration informatique n'est nécessaire que si l'on souhaite activer le mode de communication par télémétrie sériele. (12.1 Modification de la modalité de communication (depuis protocole ONVIF à télémétrie sériele), page 42).

8.11.1 Ouverture du volet de configuration

Avant de mettre l'appareil sous tension, il est nécessaire de le configurer correctement au moyen des dip-switch installés derrière le panneau de configuration. Ouvrir le panneau de configuration en desserrant les vis comme illustré en figure.

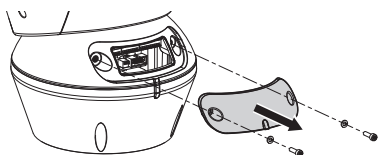

Fig. 43

Les DIP-switch sont montrés sur la figure.

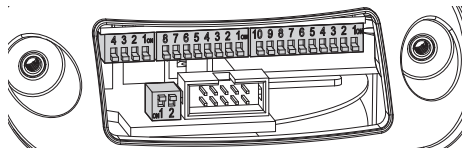

Fig. 44

i Au terme des opérations d'installation et de câblage, refermer le produit.

8.11.2 Configuration du DIP1

i Le levier du switch vers le haut représente la valeur 1 (ON). Le levier du dip-switch vers le bas représente la valeur 0 (OFF).

Le switch 1 est utilisé pour la mise à jour du micrologiciel.

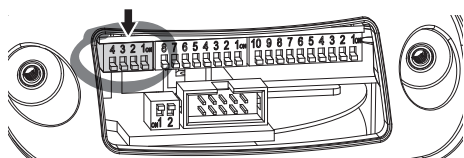

Fig. 45

CONFIGURATION DU DIP1					
Description	SW 4	SW 3	SW 2	SW 1	Baud rate
Réglage de la vitesse de transmission en bauds	OFF	OFF	OFF	-	300 baud
	ON	OFF	OFF	-	600 baud
	OFF	ON	OFF	-	1200 baud
	ON	ON	OFF	-	2400 baud
	OFF	OFF	ON	-	4800 baud
	ON	OFF	ON	-	9600 baud
	OFF	ON	ON	-	19200 baud
	ON	ON	ON	-	38400 baud
Mise à jour du firmware	-	-	-	ON	Programmation validée
	-	-	-	OFF	Programmation désactivée

Tab. 9

8.11.3 Configuration du DIP2

i Le levier du switch vers le haut représente la valeur 1 (ON). Le levier du dip-switch vers le bas représente la valeur 0 (OFF).

La tourelle est contrôlable à travers de différents protocoles.

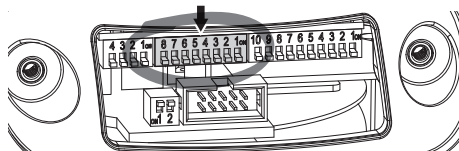

Fig. 46

CONFIGURATION DU DIP2								
Protocole	SW 8	SW 7	SW 6	SW 5	SW 4	SW 3	SW 2	SW 1
PTZ Manager ¹	OFF	OFF	OFF	OFF	OFF	OFF	OFF	OFF
MACRO (VIDEOTEC)	OFF	OFF	OFF	OFF	OFF	ON	ON	ON
PANASONIC	OFF	OFF	OFF	ON	OFF	ON	OFF	OFF
PELCO D	OFF	OFF	OFF	OFF	ON	OFF	OFF	ON
AMERICAN DYNAMICS	OFF	OFF	OFF	OFF	ON	ON	ON	OFF
VISTA	OFF	OFF	OFF	ON	OFF	OFF	ON	ON

Tab. 10 ¹ Configuration de défaut: MACRO (VIDEOTEC), 115200 baud, RS-232, Adresse 1. Cette option ne nécessite pas le réglage du DIP-switch (DIP1, DIP3).

Tab. 11

8.11.4 Configuration du DIP3

- i** Le levier du switch vers le haut représente la valeur 1 (ON). Le levier du dip-switch vers le bas représente la valeur 0 (OFF).

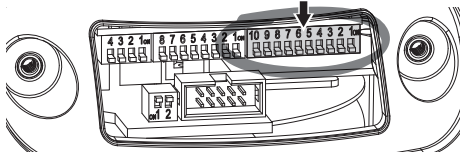

Fig. 47

8.11.4.1 Configuration de l'adresse

Les switch de 1 à 8 sont utilisés pour configurer l'adresse de l'unité (de 1 à 255).

La sélection de l'adresse s'effectue selon le code binaire (A Annexe - Tableau des adresses, page 50).

8.11.4.2 Configuration des lignes de communications sérieelles

Le produit prévoit une ligne sérieelle de communication RS-485 et une ligne sérieelle RS-232.

Les switch 10 et 9 sont utilisés pour configurer les lignes sérieelles.

CONFIGURATION DU DIP3

Description	SW 10	SW 9
Communication monodirectionnelle sur la ligne RS-485-1. Communication bidirectionnelle sur la ligne RS-232.	OFF	OFF
Communication bidirectionnelle, half-duplex, sur la ligne RS-485-1.	ON	ON

Tab. 12

8.11.5 Configuration du DIP4

- i** La configuration de ce DIP s'effectue à l'inverse des DIP précédents. Le levier du switch vers le haut représente la valeur 0 (OFF). Le levier du dip-switch vers le bas représente la valeur 1 (ON).

Sur la carte, il y a deux switches, utilisés pour configurer la terminaison (120 Ohm) des lignes sérieelles.

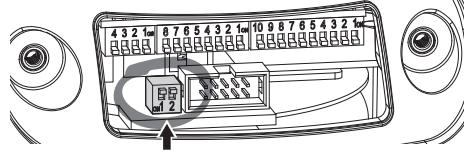

Fig. 48

Chaque unité en fin de ligne doit être terminée (bouclé) au moyen du switch prévu pour éviter tout phénomène de réflexion et de déformation du signal.

CONFIGURATION DU DIP4

Ligne sérieelle	SW 2	SW 1	Description
Factory default	-	ON	Activé
	-	OFF	Désactivé
Ligne RS-485-1	ON	-	Terminée
	OFF	-	Non terminée

Tab. 13

Pour rétablir les paramètres d'usine de la tourelle se référer au chapitre relatif. (10.1.15 Factory Default, page 39).

9 Allumage



S'assurer que l'unité et les autres composants de l'installation soient fermés de façon à empêcher le contact avec les composants sous tension.



Durant le fonctionnement normal, la surface du projecteur peut atteindre des températures élevées. Éviter le contact direct et positionner l'appareil dans un endroit non accessible au personnel non autorisé. Avant de la toucher, éteindre le dispositif d'illumination et le laisser refroidir durant 10 minutes minimum.



Ne pas rester en proximité de l'appareil lorsqu'il est sous tension. N'intervenir sur le dispositif que hors tension.



Ne pas stationner à proximité du dispositif sous tension. N'intervenir sur le dispositif qu'avec l'alimentation coupée.



La procédure de préchauffage automatique (De-Ice) peut être activée chaque fois que le dispositif est mis en fonction à une température ambiante inférieure à 0°C. La procédure permet de garantir un fonctionnement correct du dispositif également à basse température. La durée varie entre 60 et 105 minutes en fonction des conditions.

Il suffit de brancher l'alimentation électrique pour allumer l'unité.

Débrancher l'alimentation électrique pour éteindre l'unité.

10.1.3 Contrôles Utilisateur

Pour contrôler la tourelle par navigateur, sélectionner la mention Contrôle Utilisateur. Une nouvelle fenêtre s'ouvrira, avec un clavier virtuel pour sélectionner les commandes.



Fig. 52

Sur le clavier virtuel, se trouve les commandes suivantes :

- **Sélecteur vitesse:** Il permet de sélectionner la vitesse des mouvements de la tourelle.



Fig. 53

- **Zoom wide/Zoom tele**



Fig. 54

- **Focus far/Focus near/Auto focus**



Fig. 55

- **Iris close/Iris open/Auto iris**



Fig. 56

- **Wiper/Washer**



Fig. 57

- **Day:** Activer le filtre IR de la chambre. Si présents, éteint les projecteurs à LED.



Fig. 58

- **Night:** Désactiver le filtre IR de la chambre. Si présents, allume les projecteurs à LED.



Fig. 59

10.1.4 Paramètres Dispositif

A la mention du menu Paramètres Dispositif il est possible de configurer le nom de la tourelle et d'afficher d'autres informations supplémentaire.

Paramètres du dispositif	
Nom du dispositif	UlisseNet.cam
Code produit	LPT2SVMANODE
Noméro de série	113121290001
Adresse MMC	00:21:A6:00:07:D8
ID du produit	2
Micrologiciel Version: CPU Board	2.0
Micrologiciel Version: NET Board	6.0.0
Micrologiciel Version: NPP Board	6.0.0
Révision du hardware	0
Révision majeure	0
Révision mineure	0
Type de coffet	0

Fig. 60

10.1.5 Statistiques Dispositif

A la mention du menu Statistiques Dispositif on trouve, uniquement pour consultation, toutes les statistiques recueillies pendant le fonctionnement de la tourelle.

Statistiques du dispositif	
Degrés Pan	3364
Degrés TIR	1482
Albanage	134
Heures de travail	29
Température et maximum du coffet (°C)	40
Température et minimum du coffet (°C)	65454
Température et maximum de la fiche PAM (°C)	55
Température et minimum de la fiche PAM (°C)	22
Température et maximum de la fiche CPU (°C)	47
Température et minimum de la fiche CPU (°C)	20
Température et maximum de la fiche NET (°C)	40
Température et minimum de la fiche NET (°C)	19
Période d'albanage des phases R	0

Fig. 61

10.1.6 Configuration Réseau

A la mention du menu Configuration Réseau il est possible de changer la configuration de réseau de la tourelle. Il est possible de décider si le dispositif doit avoir une adresse attribuée de manière statique, dynamique avec DHCP, ou auto-générée. Le dispositif supporte le protocole Internet Protocol (IP) dans la version 4.

i Avec adresse auto-générée, le dispositif s'attribue automatiquement une adresse dans la gamme 169.254.0.0/16.

Toujours sur la même page, il est possible de configurer 2 DNS et de décider quels mécanismes doivent être actifs pour identifier automatiquement les dispositifs dans le réseau local.

Configuration réseau	
Version IP	IPv4
Type d'adresse	STATIQUE
Adresse IP (IPv4)	192.168.103.121
Masque de sous-réseau (IPv4)	255.255.255.0
Passerelle (IPv4)	192.168.103.1
Recherche automatique DNS	DÉSACTIVÉE
Serveur DNS préféré	8.8.4.4
Serveur DNS alternatif	8.8.8.8
Date & Time	2013-05-27 14:42:58 UTC
Serveur NTP	DÉSACTIVÉE
PC Sync	ACTIF
UPNP	ACTIF
Zeroconf	ACTIF
Découverte multidestinaire	ACTIF
Découverte WS	ACTIF

Fig. 62

Il est également possible de mentionner si le dispositif doit se synchroniser avec un serveur NTP (Network Time Protocol) externe.

- **NTP -> DÉSACTIVER:** Sélectionner cette option si on ne souhaite pas synchroniser date et heure du dispositif.
- **NTP -> DHCP:** Sélectionner cette option au cas où on souhaite synchroniser date et heure du dispositif avec celles d'un serveur NTP (Network Time Protocol) indiqué par le serveur DHCP.
- **NTP -> STATIQUE:** Sélectionner cette option au cas où on souhaite synchroniser date et heure du dispositif avec celles du serveur NTP indiqué par l'adresse statique.

i Pour un fonctionnement correct du dispositif, il est nécessaire de synchroniser la tourelle avec le logiciel VMS au moyen d'un serveur NTP.

i Pour un fonctionnement correct du dispositif, il est nécessaire de synchroniser la caméra avec la tourelle. Afin d'obtenir cette synchronisation, sélectionner, par la page web de la caméra, l'option NTP from DHCP, ou bien indiquer l'adresse 192.0.0.1 comme adresse statique du serveur NTP.

10.1.7 Configuration Utilisateurs

A la mention du menu Configuration Utilisateurs il est possible d'administrer les utilisateurs qui peuvent accéder à la tourelle. Les utilisateurs du type Administrateur peuvent accéder à la configuration du produit. Les utilisateurs du type Operator, User et Anonymous ont un accès limité aux pages de gestion.

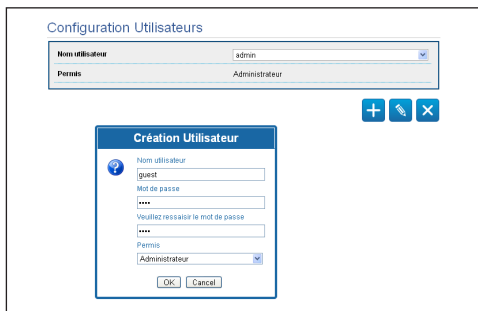

Fig. 63

i Le dispositif peut être configuré uniquement par un utilisateur avec les droits d'administrateur.

10.1.8 Paramètres Mouvement

A la mention du menu Paramètres Mouvement il est possible de contrôler par web tous les paramètres de la tourelle.

- **Offset Pan:** La tourelle a une position de 0° définie mécaniquement. La fonction Offset Pan permet de définir une position différente de 0° à l'aide du logiciel.
- **Vitesse Maximale:** Configure la vitesse manuelle maximale.
- **Vitesse avec Zoom:** Active l'option Vitesse avec Zoom. L'activation de ce paramètre réduit automatiquement la vitesse de Pan et Tilt en fonction du facteur de Zoom.
- **Facteur Tilt:** Configure le facteur de réduction de la vitesse manuelle de l'axe tilt.
- **Limites Pan:** Valide les limites de Pan.
- **Pan Début:** Configure la limite initiale de Pan.
- **Pan Fin:** Configure la limite finale de Pan.
- **Tilt Début:** Configure la limite initiale de Tilt.
- **Tilt Fin:** Configure la limite finale de Tilt.

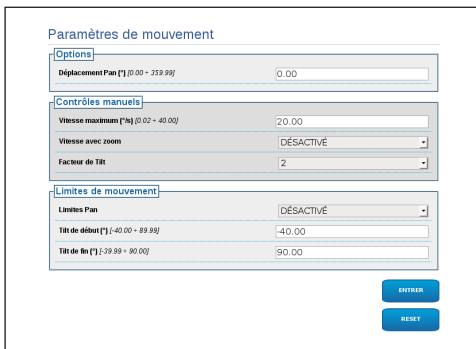

Fig. 64

10.1.8.1 Autopan

Dans la sous-section Autopan il est possible d'indiquer le preset de début et de fin de l'autopan.

Fig. 65

10.1.8.2 Patrol

Dans la sous-section Patrol il est possible d'indiquer le preset de début et de fin du patrol. Il est possible d'indiquer si l'analyse des preset doit avoir lieu de façon causale ou non.

Fig. 66

10.1.8.3 Rappel Mouvements

Dans la sous-section Rappel Mouvements il est possible d'indiquer un intervalle de temps d'inactivité au-delà duquel la tourelle effectuera une des suivantes fonctions: retour à la position Home, mise en marche de l'autopan ou mise en marche du patrol.

Fig. 67

10.1.9 Paramètres Preset

A la mention du menu Paramètres Preset on peut configurer certains paramètres concernant les preset:

- **Vitesse Scan:** La vitesse en degrés à la seconde, avec laquelle un preset est atteint, sur demande explicite de l'opérateur.
- **Type de rampe:** Permet de sélectionner les accélérations de la tourelle.
- **Vitesse Mouvements (Par Défaut):** La vitesse utilisée dans les opérations d'autopan et patrol.
- **Imposer vitesse par défaut:** La vitesse par défaut sera configurée aussi comme vitesse de scan pour tous les preset.
- **Pause Par Défaut:** Le temps en secondes de permanence par défaut de chaque preset.
- **Imposer pause par défaut:** La pause par défaut sera configurée pour tous les preset.

Fig. 68

10.1.10 Paramètres Preset (Avancé)

Dans la section Paramètres Preset (Avancé) il est possible de personnaliser les valeurs de vitesse et pause pour chaque preset, en plus que d'activer/désactiver les preset mêmes.

Fig. 69

10.1.11 I/O Numériques

Dans la carte I/O Numériques il est possible de configurer les canaux numériques présents dans la tourelle. Il y a ci-dessous une courte description des paramètres configurables pour chaque entrée numérique.

- **ID Alarme:** Champ utilisé pour sélectionner l'entrée numérique souhaitée.
- **Type:** Indique l'état par défaut de l'entrée numérique. Il peut être configuré sur Normalement Ouvert ou Normalement Fermé.
- **Action:** À chaque entrée, une action peut être associée. L'action est activée dès que le contact passe dans un état différent de celui par défaut. Les actions disponibles sont énumérées ci-dessous :
 - **NONE:** Aucune action.
 - **SCAN:** Positionner la tourelle sur la préposition sélectionnée.
 - **PATROL:** Activer le PATROL.
 - **AUTOPAN:** Activer l'AUTOPAN.
 - **WIPER:** Activer le Wiper.
 - **WASHER:** Activer la séquence de lavage de la vitre.
 - **RELAIS 1:** Activer le Relais 1.
 - **RELAIS 2:** Activer le Relais 2.
 - **IR FILT:** Désactiver le Filtre IR de la chambre. Si présents, allume les projecteurs à LED.

Pour un contrôle du fonctionnement correct des alarmes, dans la page web se trouve un petit rond. Le petit rond sera vert dans les conditions normales et rouge quand une alarme est détectée.

I/O numériques

ID Alarme	1
Type	NORMALEMENT OUVERT
Action	AUCUNE

ENTREE
REINITIALISATION

Fig. 70

10.1.12 Washer

La pompe pour le lavage de la tourelle est configurée dans la carte Washer, où il est possible d'associer un preset à l'opération de lavage, de configurer la durée du lavage du verre et d'indiquer le retard d'activation et de désactivation de l'essuie-glace.

Rondelle

Présélection buse (I = 250)	1
Retard activation essuie-glace (J = 240)	5
Retard désactivation essuie-glace (J = 240)	5

ENTREE
REINITIALISATION

Fig. 71

10.1.13 Paramètres Caméra

Les paramètres de la caméra IP qui ont été configurés à la première mise en marche sont modifiables dans la section Paramètres Caméra. Dans la section Paramètres Caméra il est possible également d'indiquer le facteur de zoom et la précision de la position du zoom. Dans cette section, il est également possible de visualiser les données relatives aux différents profils ONVIF exportés par la chambre.

À la mention du menu Lentilles il est possible de sélectionner l'une des options suivantes:

- **Motorisées:** Contrôle par la tourelle.
- **Intégrées:** Contrôle par la caméra.
- **Fixe:** Non contrôlables.

Dans le cas de lentilles motorisées, la connexion (à fil commun ou à inversion de polarité) et la polarité de rotation du Zoom, du Focus et de l'Iris peuvent être configurées.

Paramètres caméra

Protocole et Authentification

Protocole	ONVIF PROFILE S
Nom utilisateur	admin
Mot de passe	****
Réinsérer le mot de passe	****

Profils de streaming

ID Profil	0
Profil	0_PROFILE_WITH_AUDIO
Codec	MPEG4
Résolution	352 x 240
Limite framerate	30 fps
Limite bitrate	512 kbps
GOP	120 Frames
Zoom active	Oui

Caractéristiques des objectifs

Objectifs	MOTORISÉS
Facteur de zoom (1 = 50)	15
Gamme de positionnement des objectifs (0 = 250)	20
Type de moteur	INVERSION DE POLARITÉ
Polarité de rotation du Zoom	POSITIVE
Polarité de rotation du Focus	NÉGATIVE
Polarité de rotation de l'Iris	POSITIVE
Sonde IR	NONE

ENTREE
RESET

Fig. 72

Pour modifier les configurations de la caméra, sélectionner le bouton VTTunnel (10.1.14 Instruments, page 38).

10.1.14 Instruments

À la mention du menu Instruments il est possible de reconfigurer les valeurs prédéfinies pour toute la configuration de la tourelle ou seulement pour certaines sections spécifiques.

Dans cette section, il est en outre possible :

- Mettre à jour le firmware du dispositif.
- Redémarrer la tourelle.
- Télécharger le logiciel VTTunnel pour activer la connexion avec la chambre IP, indispensable pour accéder à la page web de celle-ci.

Outils

- RÉINITIALISATION PRÉDÉFINIES** : élimination de toutes les présélections.
- RÉINITIALISATION PARAMÈTRES** : Réinitialisation des paramètres de Mouvement, des Paramètres de la rondelle et des ID numériques aux valeurs de défaut.
- RÉINITIALISATION VTTUNNEL** : Réinitialisation démarrages d'identification.
- RÉINITIALISATION RÉSEAU** : Réinitialisation des réglages de réseau.
- RÉINITIALISATION OS** : Réinitialisation de tous les réglages.
- METTRE À JOUR LE MICROLOGICIEL** : Mise-à-jour des micrologiciels du dispositif. [BROWSER...]
- REDÉMARRER** : Redémarrage du dispositif.
- VTTUNNEL** : Télécharger et exécuter le programme VTTunnel pour avoir accès à la page de la caméra.

Fig. 73

10.1.15 Factory Default

⚠ Si le mot de passe ne est plus disponible, il est possible de rétablir les paramètres d'usine à l'aide de la touche reset, situé à l'intérieur de la base.

Pour restaurer les configurations d'usine relatives au réseau, à l'accès utilisateurs et à la configuration de la chambre, suivre la procédure:

- Allumer l'unité.
- Ouvrir le volet du commutateur DIP.
- Localiser le commutateur DIP 4 (01). Porter le commutateur 1 vers le bas, valeur 1 (ON).
- Attendre l'extinction temporaire des LED (02).
- Reporter le commutateur 1 vers le haut, valeur 0 (OFF).
- Fermer le panneau.

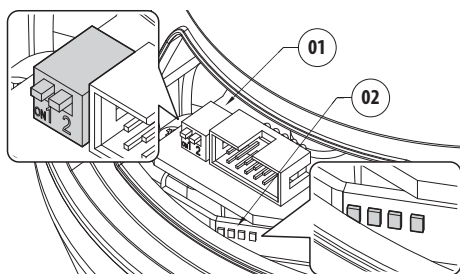

Fig. 74

10.2 VTTunnel

i Le logiciel fonctionne seulement avec Java™. Si Java™ n'a pas été précédemment installé, télécharger la dernière version du site www.java.com.

i Le logiciel peut se connecter seulement à la première interface de réseau actif. Ne laisser connecté que le câble de réseau, relié à la tourelle.

i L'exécution du logiciel requiert les privilèges d'administration de l'ordinateur. Le message You have to execute javaw as administrator pourrait apparaître sur le moniteur. Dans ce cas, il sera nécessaire de modifier les propriétés d'exécution du fichier javaw.exe situé dans le dossier d'installation de Java.

Afin de connecter la caméra IP, vous devez utiliser le programme de VTTunnel, démarrable du menu Instruments.

Au lancement du programme, sera montrée une liste des dispositifs en réseau. Pour se connecter à la chambre, il est nécessaire de sélectionner la tourelle souhaitée et d'appuyer sur le touche Connect.

Une fois que la connexion est établie, la page Web de la caméra IP sera atteinte à l'adresse 192.0.0.64.

Lorsque les opérations sur la caméra seront terminées, vous pouvez fermer la connexion en cliquant sur le touche Disconnect. Il est possible de se connecter à une caméra à la fois et donc nécessaire de se déconnecter de la tourelle avant d'agir sur un'autre unité de positionnement.

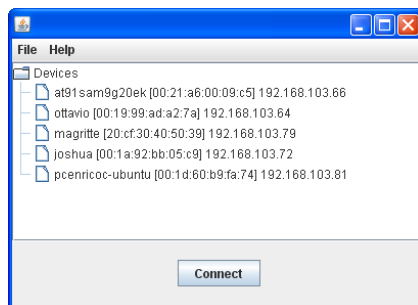

Fig. 75

i Si pendant la configuration de la caméra, les paramètres de streaming vidéo sont modifiés, il faut redémarrer la tourelle.

11 Accessoires

i Pour de plus amples informations sur la configuration et l'utilisation, consulter le manuel de l'accessoire correspondant.

11.1 Système de lavage

La tourelle peut être équipée d'une pompe extérieure qui fournit de l'eau pour le nettoyage de la vitre.

Lorsque l'on envoie la commande, la tourelle se positionne avec la vitre devant la buse (10.1.3 Contrôles Utilisateur, page 33). La pompe et l'essuie-glace sont validés pendant une durée déterminée. À la fin de la procédure la tourelle revient dans sa position initiale.

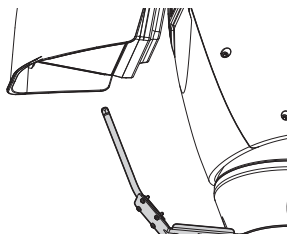

Fig. 76

11.1.1 Branchement du système de lavage

! ATTENTION! L'installation est du type TNV-1. Ne pas la connecter à des circuits SELV.

! ATTENTION! Pour réduire les risques d'incendie, utiliser uniquement des câbles certifiés UL Listed ou CSA de dimensions égales ou supérieures à 0.13mm² (26 AWG).

! Tous les câbles de signalisation doivent également être regroupés avec un collier.

BRANCHEMENT DU SYSTÈME DE LAVAGE	
Bornes	Description
O1-C1	Contact sec pour activation du système de lavage.

Tab. 14

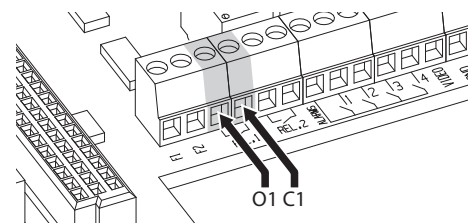

Fig. 77

11.2 Support fixation murale

Support mural avec passage interne des câbles.

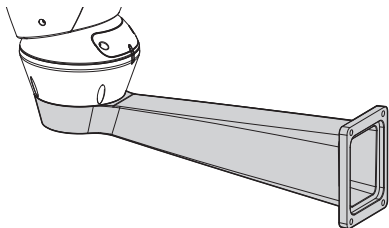

Fig. 78

11.3 Support fixation sol

Support de fixation au sol avec passage interne des câbles.

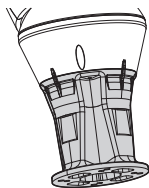

Fig. 79

11.4 Alimentateur avec contrôle des projecteurs.

Boîte étanche avec alimentateur et contrôle des projecteurs.

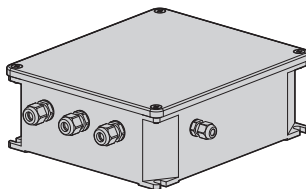

Fig. 80 Version du boîtier standard.

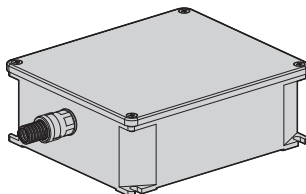

Fig. 81 Version du boîtier certifié UL.



Pour d'autres renseignements se référer à le chapitre relatif (8.4.3 Branchement des entrées d'alarme, de l'interrupteur crépusculaire et des relais, page 22).

12 Instructions de fonctionnement exceptionnel

12.1 Modification de la modalit e de communication (depuis protocole ONVIF  a t el em etrie s erieelle)

La tourelle est configur ee   l'origine pour communiquer par protocole ONVIF.

12.1.1 Proc dure de modification de la modalit e de communication

 teindre la tourelle.

R gler les dip-switch (8.11 Configuration du mat riel, page 29). Suivre la proc dure indiqu ee ci-apr es:

Baud rate: 38400 (ON ON ON OFF)

Protocole: MACRO (OFF OFF OFF OFF OFF ON ON ON)

Communication s erieelle et adresse de t el em etrie:

RS-485 half-duplex, adresse 1 (ON ON OFF OFF OFF OFF OFF ON)

Allumer la tourelle.

  partir du browser, saisir l'adresse <indirizzo_ip>/cgi-bin/pc.cgi.



Fig. 82

Changer le code produit: la lettre N est remplac ee par Y. Exemple: De UPT2SVUAN00E   UPT2SVUAY00E.

Cliquer sur Envoi. Confirmer le red marrage du produit.

  partir du browser, saisir l'adresse <indirizzo_ip>/cgi-bin/pc.cgi pour v erifier que le code produit soit chang e. En cas de probl emes, r p ter la proc dure depuis le d but.

 teindre la tourelle.

Mettre sur OFF les dip-switch illustr es sur la figure.

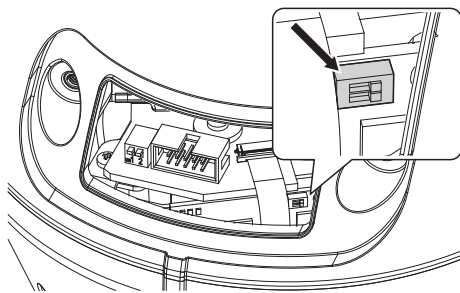

Fig. 83

Configurer la communication s erieelle de la tourelle comme requis par la cam ra. Agir sur les dip-switch des communications s erieelles. (8.11 Configuration du mat riel, page 29).

Connecter la porte s erieelle de la cam ra au connecteur.

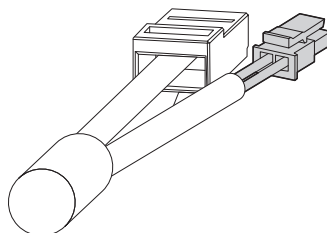

Fig. 84 Gris: RS-485 +. Rose: RS-485 -.

Brancher l'alimentation des cam ras.

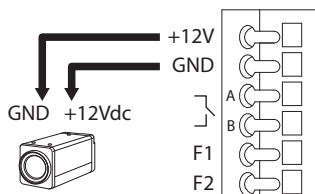

Fig. 85

Allumer la tourelle.

La tourelle est alors configur ee pour communiquer par t el em etrie s erieelle (RS-485).

13 Entretien



L'entretien doit être **uniquement effectué par un personnel qualifié en matière de circuits électriques.**

13.1 Remplacement des fusibles



Il faut effectuer l'entretien en **absence d'alimentation et lorsque le dispositif de sectionnement ouvert.**

En cas de nécessité remplacer le fusible illustrée sur la figure (8.3 Description de la carte de connexion, page 19).

REPLACEMENT DES FUSIBLES		
Tension	Fusible F1	Fusible F2
24Vac, 50/60Hz	F 6.3A L 250V 5x20	T 8A H 250V 5x20
120Vac, 50/60Hz	F 6.3A L 250V 5x20	T 4A H 250V 5x20
230Vac, 50/60Hz	F 6.3A L 250V 5x20	T 2A H 250V 5x20

Tab. 15

14 Nettoyage

14.1 Entretien de la vitre et des parties en plastique



On doit éviter **alcool éthylique, solvants, hydrocarbures hydro-génés, acides forts et alcali. L'emploi de ce type de produits abîme d'une façon irréparable la surface traitée.**

Il est conseillé d'utiliser un chiffon souple avec des savons neutres dilués avec de l'eau ou des produits spécifiques pour le nettoyage des verres des lunettes.

14.2 Nettoyage de la fenêtre au germanium



Nettoyer la fenêtre en ayant soin de ne pas rayer ni érafler l'enduit protecteur de carbone externe. L'endommagement du revêtement risque de compromettre la transparence à l'infrarouge de la surface.

Le nettoyage doit être fait avec du savon neutre dilué avec de l'eau.

15 Élimination des déchets



Ce symbole et le système de recyclage ne sont appliqués que dans les pays UE et non dans les autres pays du monde.

Votre produit est conçu et fabriqué avec des matériels et des composants de qualité supérieure qui peuvent être recyclés et réutilisés.

Ce symbole signifie que les équipements électriques et électroniques en fin de vie doivent être éliminés séparément des ordures ménagères.

Nous vous prions donc de confier cet équipement à votre Centre local de collecte ou Recyclage.

Dans l'Union Européenne, il existe des systèmes sélectifs de collecte pour les produits électriques et électroniques usagés.

16 Dépannage

Demander l'intervention d'un personnel qualifié dans les cas suivants:

- L'unité est endommagée à la suite d'une chute;
- Les performances de l'unité ont baissé.
- L'unité ne fonctionne pas correctement après avoir respecté toutes les indications de ce manuel.

PROBLÈME	Le produit ne s'allume pas.
CAUSE	<i>Câblage incorrect, rupture des fusibles.</i>
SOLUTION	Vérifier les connexions. Vérifié la continuité des fusibles et les remplacer avec les modèles indiqués en cas de panne.

PROBLÈME	Dans des conditions particulières de zoom, une interférence se produit entre le caisson ou le toit et l'image filmée (version avec système optique motorisé uniquement).
CAUSE	<i>Position de la caméra ou de l'optique trop en retrait par rapport à la vitre.</i>
SOLUTION	Régler la position de la caméra et de l'optique.

PROBLÈME	Il n'est pas possible de se brancher à la caméra.
CAUSE	<i>Branchement erroné de la caméra.</i>
SOLUTION	Vérifier les branchements de la caméra.
PROBLÈME	Durant la mise en service, la tourelle reste bloquée.
CAUSE	<i>La température ambiante est très basse.</i>
SOLUTION	Attendre la fin de la procédure de préchauffage.
PROBLÈME	Il n'est pas possible de contrôler la tourelle.
CAUSE	<i>Configuration erronée de la ligne de communication.</i>
SOLUTION	Vérifier la configuration des dip-switch (8.11 Configuration du matériel, page 29).

17 Données techniques

17.1 Généralités

Fabriqué en fonte d'aluminium et en technopolymère

Vernissage avec poudres époxypolyester, couleur RAL9002

Caisson positionné en partie supérieure (OTT)

Transmission par courroie dentée de haute précision

Slip-ring

Fins de course électroniques

Installation et intervention simplifiée grâce au connecteur

Aucun jeu mécanique

Encodeur pour la précision de positionnement

Essuie-glace intégré

Paramètres de configuration du protocole de télémétrie par dip-switch pour RS485

17.2 Mécanique

Presse-étoupes: 3xM16

Rotation horizontale: continue

Rotation verticale: de +90° à -40°

Vitesse horizontale (variable): de 0.02°/s à 100°/s (de 0.02°/s à 40°/s, pour projecteurs à LED)

Vitesse verticale (variable): de 0.02°/s à 50°/s (de 0.02°/s à 30°/s, pour projecteurs à LED)

Surface intérieure utile: Voir dessins

Vitre du caisson (WxH): 124x112mm

Précision du rappel des prépositions: 0.02°

Poids net: 16.8kg (17.8kg, avec support pour projecteurs à LED)

17.3 Électricité

Compatible avec des caméras network

Tension d'alimentation/Courant absorbé:

- 230Vac, 0.4A, 50/60Hz
- 24Vac, 4A (8A pour projecteurs à LED), 50/60Hz
- 120Vac, 0.8A, 50/60Hz

Puissance absorbée:

- 100W
- 150-190W max pour projecteurs à LED en 24Vac
- 28.5W, tourelle à l'arrêt, chauffage éteint

Alimentation caméra: 12Vdc (800mA)

4 sorties d'alarmes auto-alimentées

2 contacts secs: 30Vdc max o30Vac, @ 1A

17.4 Communications

Connexion Ethernet: IEEE 802.3 100Base-Tx

17.5 Protocoles

ONVIF, profil S

17.6 Environnement

Intérieur/Extérieur

Température de fonctionnement

- Avec chauffage: -20°C/+60°C
- Avec chauffage renforcé: -30°C/+60°C

Protection contre les impulsions: jusqu'à 2kV entre ligne et ligne, jusqu'à 4kV entre ligne et terre (Classe 4)

17.7 Certifications

Sécurité électrique (CE): EN60950-1, IEC60950-1

Compatibilité électromagnétique (CE): EN50130-4, EN610000-6-4, EN55022 (Classe A), FCC Part 15 (Classe A)

Installation à l'extérieur (CE): EN60950-22, IEC60950-22

Sécurité photobiologique (CE): EN62471 projecteurs à LED)

Degré de protection IP: EN60529, IP66

Résistant au brume saline: EN50130-5, EN60068-2-52

Certification UL: cULus Listed (TYPE 4X)

Certification EAC

18 Dessins techniques

i Les dimensions des dessins sont exprimées en millimètres.

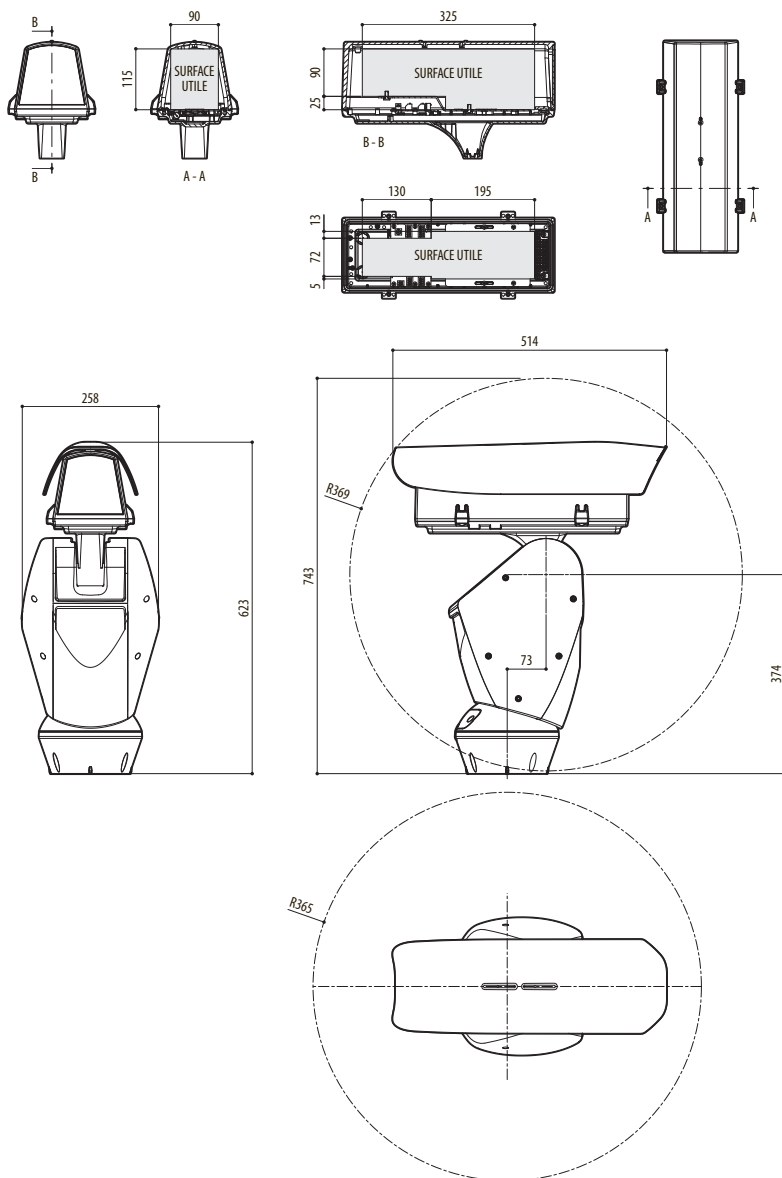

Fig. 86 ULISSE PLUS NETCAM.

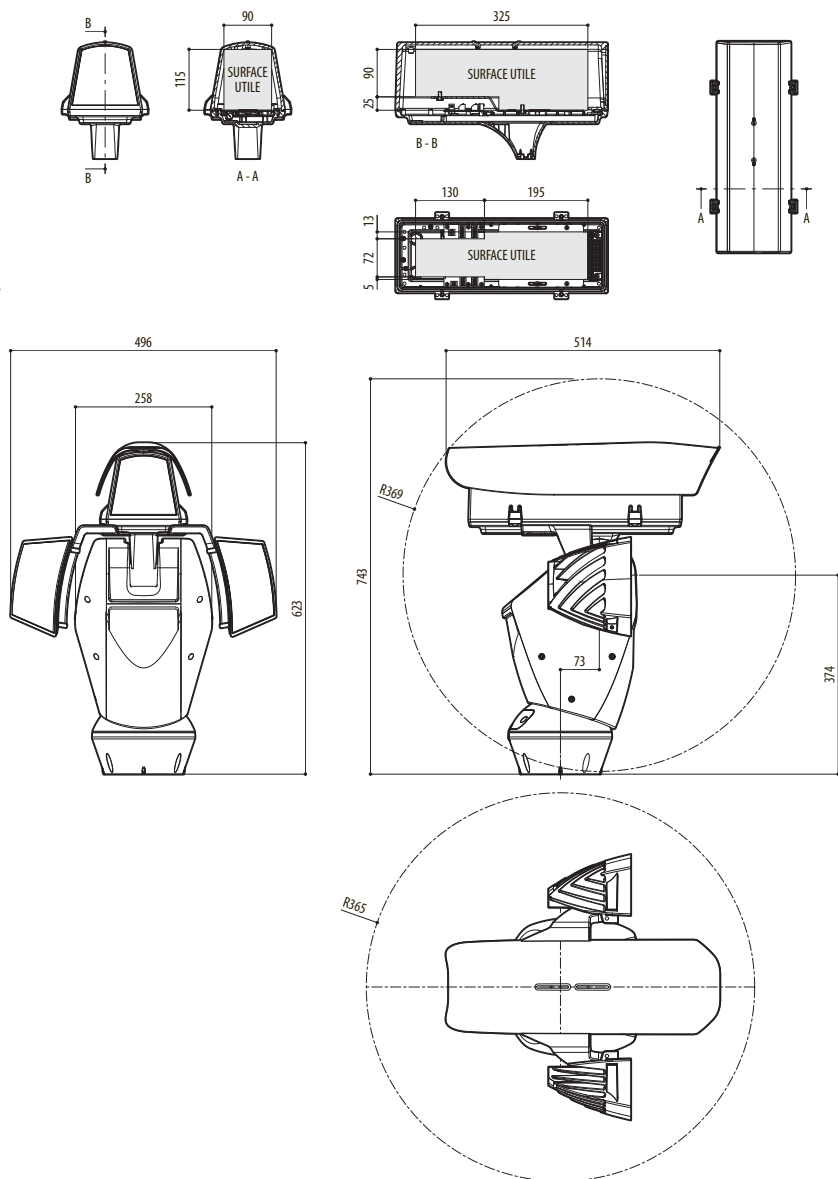

Fig. 87 ULISSE PLUS NETCAM, version avec prédisposition pour le montage des deux projecteurs à LED.

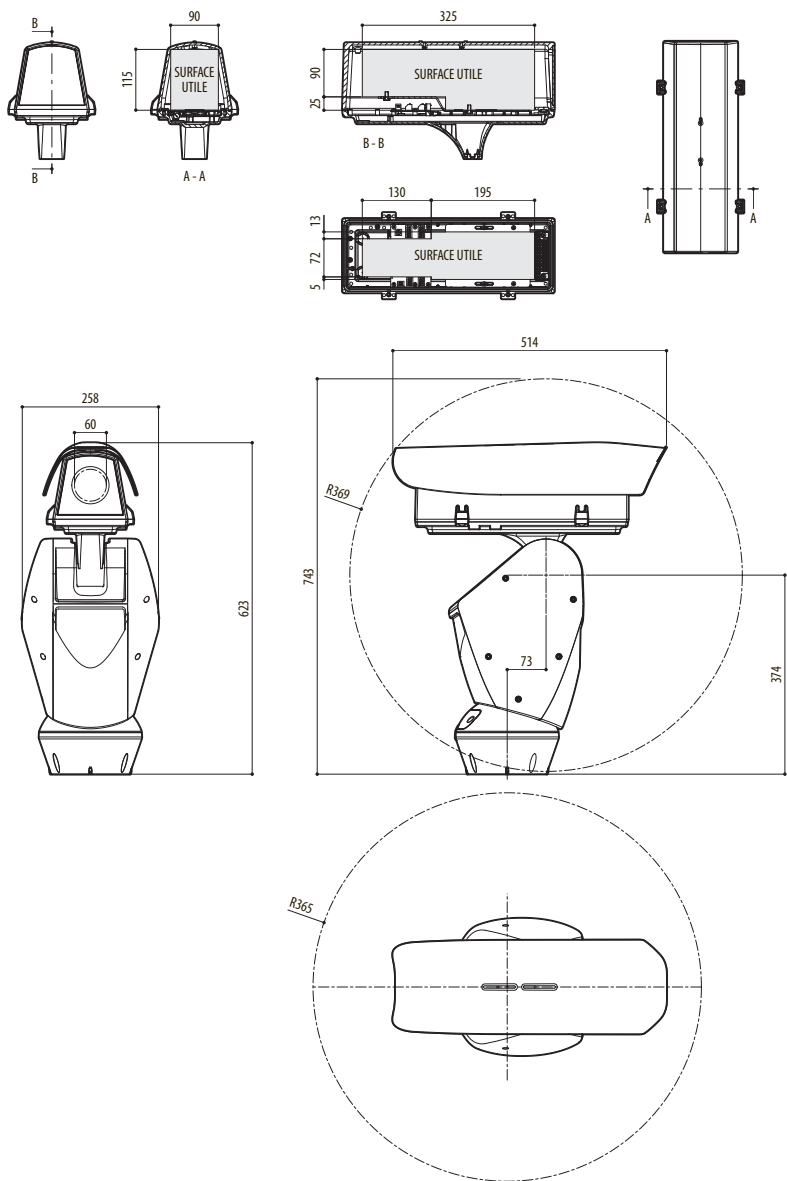

Fig. 88 ULISSE PLUS NETCAM, version pour caméras thermiques.

A Annexe - Tableau des adresses



Le levier du switch vers le haut représente la valeur 1 (ON). Le levier du dip-switch vers le bas représente la valeur 0 (OFF).

Ci-après, on reporte toutes les combinaisons possibles.

CONFIGURATION DE L'ADRESSE (DIP 3)								
SW 8	SW 7	SW 6	SW 5	SW 4	SW 3	SW 2	SW 1	Adresse
OFF	OFF	OFF	OFF	OFF	OFF	OFF	OFF	Adresse non valide
OFF	OFF	OFF	OFF	OFF	OFF	OFF	ON	Adresse 1
OFF	OFF	OFF	OFF	OFF	OFF	ON	OFF	Adresse 2
OFF	OFF	OFF	OFF	OFF	OFF	ON	ON	Adresse 3
OFF	OFF	OFF	OFF	OFF	ON	OFF	OFF	Adresse 4
OFF	OFF	OFF	OFF	OFF	ON	OFF	ON	Adresse 5
OFF	OFF	OFF	OFF	OFF	ON	ON	OFF	Adresse 6
OFF	OFF	OFF	OFF	OFF	ON	ON	ON	Adresse 7
OFF	OFF	OFF	OFF	ON	OFF	OFF	OFF	Adresse 8
OFF	OFF	OFF	OFF	ON	OFF	OFF	ON	Adresse 9
OFF	OFF	OFF	OFF	ON	OFF	ON	OFF	Adresse 10
OFF	OFF	OFF	OFF	ON	ON	ON	ON	Adresse 11
OFF	OFF	OFF	OFF	ON	ON	OFF	OFF	Adresse 12
OFF	OFF	OFF	OFF	ON	ON	OFF	ON	Adresse 13
OFF	OFF	OFF	OFF	ON	ON	ON	OFF	Adresse 14
OFF	OFF	OFF	OFF	ON	ON	ON	ON	Adresse 15
OFF	OFF	OFF	ON	OFF	OFF	OFF	OFF	Adresse 16
OFF	OFF	OFF	ON	OFF	OFF	OFF	ON	Adresse 17
OFF	OFF	OFF	ON	OFF	OFF	ON	OFF	Adresse 18
OFF	OFF	OFF	ON	OFF	OFF	ON	ON	Adresse 19
OFF	OFF	OFF	ON	OFF	ON	OFF	OFF	Adresse 20
OFF	OFF	OFF	ON	OFF	ON	OFF	ON	Adresse 21
OFF	OFF	OFF	ON	OFF	ON	ON	OFF	Adresse 22
OFF	OFF	OFF	ON	OFF	ON	ON	ON	Adresse 23
OFF	OFF	OFF	ON	ON	OFF	OFF	OFF	Adresse 24
OFF	OFF	OFF	ON	ON	OFF	OFF	ON	Adresse 25
OFF	OFF	OFF	ON	ON	OFF	ON	OFF	Adresse 26
OFF	OFF	OFF	ON	ON	OFF	ON	ON	Adresse 27
OFF	OFF	OFF	ON	ON	ON	OFF	OFF	Adresse 28
OFF	OFF	OFF	ON	ON	ON	OFF	ON	Adresse 29
OFF	OFF	OFF	ON	ON	ON	ON	OFF	Adresse 30
OFF	OFF	OFF	ON	ON	ON	ON	ON	Adresse 31
OFF	OFF	ON	OFF	OFF	OFF	OFF	OFF	Adresse 32
OFF	OFF	ON	OFF	OFF	OFF	OFF	ON	Adresse 33
OFF	OFF	ON	OFF	OFF	OFF	ON	OFF	Adresse 34
OFF	OFF	ON	OFF	OFF	OFF	ON	ON	Adresse 35
OFF	OFF	ON	OFF	OFF	ON	OFF	OFF	Adresse 36
OFF	OFF	ON	OFF	OFF	ON	OFF	ON	Adresse 37
OFF	OFF	ON	OFF	OFF	ON	ON	OFF	Adresse 38

CONFIGURATION DE L'ADRESSE (DIP 3)								
SW 8	SW 7	SW 6	SW 5	SW 4	SW 3	SW 2	SW 1	Adresse
OFF	OFF	ON	OFF	OFF	ON	ON	ON	Adresse 39
OFF	OFF	ON	OFF	ON	OFF	OFF	OFF	Adresse 40
OFF	OFF	ON	OFF	ON	OFF	OFF	ON	Adresse 41
OFF	OFF	ON	OFF	ON	OFF	ON	OFF	Adresse 42
OFF	OFF	ON	OFF	ON	OFF	ON	ON	Adresse 43
OFF	OFF	ON	OFF	ON	ON	OFF	OFF	Adresse 44
OFF	OFF	ON	OFF	ON	ON	OFF	ON	Adresse 45
OFF	OFF	ON	OFF	ON	ON	ON	OFF	Adresse 46
OFF	OFF	ON	OFF	ON	ON	ON	ON	Adresse 47
OFF	OFF	ON	ON	OFF	OFF	OFF	OFF	Adresse 48
OFF	OFF	ON	ON	OFF	OFF	OFF	ON	Adresse 49
OFF	OFF	ON	ON	OFF	OFF	ON	OFF	Adresse 50
OFF	OFF	ON	ON	OFF	OFF	ON	ON	Adresse 51
OFF	OFF	ON	ON	OFF	ON	OFF	OFF	Adresse 52
OFF	OFF	ON	ON	OFF	ON	OFF	ON	Adresse 53
OFF	OFF	ON	ON	OFF	ON	ON	OFF	Adresse 54
OFF	OFF	ON	ON	OFF	ON	ON	ON	Adresse 55
OFF	OFF	ON	ON	ON	OFF	OFF	OFF	Adresse 56
OFF	OFF	ON	ON	ON	OFF	OFF	ON	Adresse 57
OFF	OFF	ON	ON	ON	OFF	ON	OFF	Adresse 58
OFF	OFF	ON	ON	ON	OFF	ON	ON	Adresse 59
OFF	OFF	ON	ON	ON	ON	OFF	OFF	Adresse 60
OFF	OFF	ON	ON	ON	ON	OFF	ON	Adresse 61
OFF	OFF	ON	ON	ON	ON	ON	OFF	Adresse 62
OFF	OFF	ON	ON	ON	ON	ON	ON	Adresse 63
OFF	ON	OFF	OFF	OFF	OFF	OFF	OFF	Adresse 64
OFF	ON	OFF	OFF	OFF	OFF	OFF	ON	Adresse 65
OFF	ON	OFF	OFF	OFF	OFF	ON	OFF	Adresse 66
OFF	ON	OFF	OFF	OFF	OFF	ON	ON	Adresse 67
OFF	ON	OFF	OFF	OFF	ON	OFF	OFF	Adresse 68
OFF	ON	OFF	OFF	OFF	ON	OFF	ON	Adresse 69
OFF	ON	OFF	OFF	OFF	ON	ON	OFF	Adresse 70
OFF	ON	OFF	OFF	OFF	ON	ON	ON	Adresse 71
OFF	ON	OFF	OFF	ON	OFF	OFF	OFF	Adresse 72
OFF	ON	OFF	OFF	ON	OFF	OFF	ON	Adresse 73
OFF	ON	OFF	OFF	ON	OFF	ON	OFF	Adresse 74
OFF	ON	OFF	OFF	ON	OFF	ON	ON	Adresse 75
OFF	ON	OFF	OFF	ON	ON	OFF	OFF	Adresse 76
OFF	ON	OFF	OFF	ON	ON	OFF	ON	Adresse 77
OFF	ON	OFF	OFF	ON	ON	ON	OFF	Adresse 78
OFF	ON	OFF	OFF	ON	ON	ON	ON	Adresse 79
OFF	ON	OFF	ON	OFF	OFF	OFF	OFF	Adresse 80
OFF	ON	OFF	ON	OFF	OFF	OFF	ON	Adresse 81
OFF	ON	OFF	ON	OFF	OFF	ON	OFF	Adresse 82

CONFIGURATION DE L'ADRESSE (DIP 3)								
SW 8	SW 7	SW 6	SW 5	SW 4	SW 3	SW 2	SW 1	Adresse
OFF	ON	OFF	ON	OFF	OFF	ON	ON	Adresse 83
OFF	ON	OFF	ON	OFF	ON	OFF	OFF	Adresse 84
OFF	ON	OFF	ON	OFF	ON	OFF	ON	Adresse 85
OFF	ON	OFF	ON	OFF	ON	ON	OFF	Adresse 86
OFF	ON	OFF	ON	OFF	ON	ON	ON	Adresse 87
OFF	ON	OFF	ON	ON	OFF	OFF	OFF	Adresse 88
OFF	ON	OFF	ON	ON	OFF	OFF	ON	Adresse 89
OFF	ON	OFF	ON	ON	OFF	ON	OFF	Adresse 90
OFF	ON	OFF	ON	ON	OFF	ON	ON	Adresse 91
OFF	ON	OFF	ON	ON	ON	OFF	OFF	Adresse 92
OFF	ON	OFF	ON	ON	ON	OFF	ON	Adresse 93
OFF	ON	OFF	ON	ON	ON	ON	OFF	Adresse 94
OFF	ON	OFF	ON	ON	ON	ON	ON	Adresse 95
OFF	ON	ON	OFF	OFF	OFF	OFF	OFF	Adresse 96
OFF	ON	ON	OFF	OFF	OFF	OFF	ON	Adresse 97
OFF	ON	ON	OFF	OFF	OFF	ON	OFF	Adresse 98
OFF	ON	ON	OFF	OFF	OFF	ON	ON	Adresse 99
OFF	ON	ON	OFF	OFF	ON	OFF	OFF	Adresse 100
OFF	ON	ON	OFF	OFF	ON	OFF	ON	Adresse 101
OFF	ON	ON	OFF	OFF	ON	ON	OFF	Adresse 102
OFF	ON	ON	OFF	OFF	ON	ON	ON	Adresse 103
OFF	ON	ON	OFF	ON	OFF	OFF	OFF	Adresse 104
OFF	ON	ON	OFF	ON	OFF	OFF	ON	Adresse 105
OFF	ON	ON	OFF	ON	OFF	ON	OFF	Adresse 106
OFF	ON	ON	OFF	ON	OFF	ON	ON	Adresse 107
OFF	ON	ON	OFF	ON	ON	OFF	OFF	Adresse 108
OFF	ON	ON	OFF	ON	ON	OFF	ON	Adresse 109
OFF	ON	ON	OFF	ON	ON	ON	OFF	Adresse 110
OFF	ON	ON	OFF	ON	ON	ON	ON	Adresse 111
OFF	ON	ON	ON	OFF	OFF	OFF	OFF	Adresse 112
OFF	ON	ON	ON	OFF	OFF	OFF	ON	Adresse 113
OFF	ON	ON	ON	OFF	OFF	ON	OFF	Adresse 114
OFF	ON	ON	ON	OFF	OFF	ON	ON	Adresse 115
OFF	ON	ON	ON	OFF	ON	OFF	OFF	Adresse 116
OFF	ON	ON	ON	OFF	ON	OFF	ON	Adresse 117
OFF	ON	ON	ON	OFF	ON	ON	OFF	Adresse 118
OFF	ON	ON	ON	OFF	ON	ON	ON	Adresse 119
OFF	ON	ON	ON	ON	OFF	OFF	OFF	Adresse 120
OFF	ON	ON	ON	ON	OFF	OFF	ON	Adresse 121
OFF	ON	ON	ON	ON	OFF	ON	OFF	Adresse 122
OFF	ON	ON	ON	ON	OFF	ON	ON	Adresse 123
OFF	ON	ON	ON	ON	ON	OFF	OFF	Adresse 124
OFF	ON	ON	ON	ON	ON	OFF	ON	Adresse 125
OFF	ON	ON	ON	ON	ON	ON	OFF	Adresse 126

CONFIGURATION DE L'ADRESSE (DIP 3)

SW 8	SW 7	SW 6	SW 5	SW 4	SW 3	SW 2	SW 1	Adresse
OFF	ON	ON	ON	ON	ON	ON	ON	Adresse 127
ON	OFF	OFF	OFF	OFF	OFF	OFF	OFF	Adresse 128
ON	OFF	OFF	OFF	OFF	OFF	OFF	ON	Adresse 129
ON	OFF	OFF	OFF	OFF	OFF	ON	OFF	Adresse 130
ON	OFF	OFF	OFF	OFF	OFF	ON	ON	Adresse 131
ON	OFF	OFF	OFF	OFF	ON	OFF	OFF	Adresse 132
ON	OFF	OFF	OFF	OFF	ON	OFF	ON	Adresse 133
ON	OFF	OFF	OFF	OFF	ON	ON	OFF	Adresse 134
ON	OFF	OFF	OFF	OFF	ON	ON	ON	Adresse 135
ON	OFF	OFF	OFF	ON	OFF	OFF	OFF	Adresse 136
ON	OFF	OFF	OFF	ON	OFF	OFF	ON	Adresse 137
ON	OFF	OFF	OFF	ON	OFF	ON	OFF	Adresse 138
ON	OFF	OFF	OFF	ON	OFF	ON	ON	Adresse 139
ON	OFF	OFF	OFF	ON	ON	OFF	OFF	Adresse 140
ON	OFF	OFF	OFF	ON	ON	OFF	ON	Adresse 141
ON	OFF	OFF	OFF	ON	ON	ON	OFF	Adresse 142
ON	OFF	OFF	OFF	ON	ON	ON	ON	Adresse 143
ON	OFF	OFF	ON	OFF	OFF	OFF	OFF	Adresse 144
ON	OFF	OFF	ON	OFF	OFF	OFF	ON	Adresse 145
ON	OFF	OFF	ON	OFF	OFF	ON	OFF	Adresse 146
ON	OFF	OFF	ON	OFF	OFF	ON	ON	Adresse 147
ON	OFF	OFF	ON	OFF	ON	OFF	OFF	Adresse 148
ON	OFF	OFF	ON	OFF	ON	OFF	ON	Adresse 149
ON	OFF	OFF	ON	OFF	ON	ON	OFF	Adresse 150
ON	OFF	OFF	ON	OFF	ON	ON	ON	Adresse 151
ON	OFF	OFF	ON	ON	OFF	OFF	OFF	Adresse 152
ON	OFF	OFF	ON	ON	OFF	OFF	ON	Adresse 153
ON	OFF	OFF	ON	ON	OFF	ON	OFF	Adresse 154
ON	OFF	OFF	ON	ON	OFF	ON	ON	Adresse 155
ON	OFF	OFF	ON	ON	ON	OFF	OFF	Adresse 156
ON	OFF	OFF	ON	ON	ON	OFF	ON	Adresse 157
ON	OFF	OFF	ON	ON	ON	ON	OFF	Adresse 158
ON	OFF	OFF	ON	ON	ON	ON	ON	Adresse 159
ON	OFF	ON	OFF	OFF	OFF	OFF	OFF	Adresse 160
ON	OFF	ON	OFF	OFF	OFF	OFF	ON	Adresse 161
ON	OFF	ON	OFF	OFF	OFF	ON	OFF	Adresse 162
ON	OFF	ON	OFF	OFF	OFF	ON	ON	Adresse 163
ON	OFF	ON	OFF	OFF	ON	OFF	OFF	Adresse 164
ON	OFF	ON	OFF	OFF	ON	OFF	ON	Adresse 165
ON	OFF	ON	OFF	OFF	ON	ON	OFF	Adresse 166
ON	OFF	ON	OFF	OFF	ON	ON	ON	Adresse 167
ON	OFF	ON	OFF	ON	OFF	OFF	OFF	Adresse 168
ON	OFF	ON	OFF	ON	OFF	OFF	ON	Adresse 169
ON	OFF	ON	OFF	ON	OFF	ON	OFF	Adresse 170

CONFIGURATION DE L'ADRESSE (DIP 3)								
SW 8	SW 7	SW 6	SW 5	SW 4	SW 3	SW 2	SW 1	Adresse
ON	OFF	ON	OFF	ON	OFF	ON	ON	Adresse 171
ON	OFF	ON	OFF	ON	ON	OFF	OFF	Adresse 172
ON	OFF	ON	OFF	ON	ON	OFF	ON	Adresse 173
ON	OFF	ON	OFF	ON	ON	ON	OFF	Adresse 174
ON	OFF	ON	OFF	ON	ON	ON	ON	Adresse 175
ON	OFF	ON	ON	OFF	OFF	OFF	OFF	Adresse 176
ON	OFF	ON	ON	OFF	OFF	OFF	ON	Adresse 177
ON	OFF	ON	ON	OFF	OFF	ON	OFF	Adresse 178
ON	OFF	ON	ON	OFF	OFF	ON	ON	Adresse 179
ON	OFF	ON	ON	OFF	ON	OFF	OFF	Adresse 180
ON	OFF	ON	ON	OFF	ON	OFF	ON	Adresse 181
ON	OFF	ON	ON	OFF	ON	ON	OFF	Adresse 182
ON	OFF	ON	ON	OFF	ON	ON	ON	Adresse 183
ON	OFF	ON	ON	ON	OFF	OFF	OFF	Adresse 184
ON	OFF	ON	ON	ON	OFF	OFF	ON	Adresse 185
ON	OFF	ON	ON	ON	OFF	ON	OFF	Adresse 186
ON	OFF	ON	ON	ON	OFF	ON	ON	Adresse 187
ON	OFF	ON	ON	ON	ON	OFF	OFF	Adresse 188
ON	OFF	ON	ON	ON	ON	OFF	ON	Adresse 189
ON	OFF	ON	ON	ON	ON	ON	OFF	Adresse 190
ON	OFF	ON	ON	ON	ON	ON	ON	Adresse 191
ON	ON	OFF	OFF	OFF	OFF	OFF	OFF	Adresse 192
ON	ON	OFF	OFF	OFF	OFF	OFF	ON	Adresse 193
ON	ON	OFF	OFF	OFF	OFF	ON	OFF	Adresse 194
ON	ON	OFF	OFF	OFF	OFF	ON	ON	Adresse 195
ON	ON	OFF	OFF	OFF	ON	OFF	OFF	Adresse 196
ON	ON	OFF	OFF	OFF	ON	OFF	ON	Adresse 197
ON	ON	OFF	OFF	OFF	ON	ON	OFF	Adresse 198
ON	ON	OFF	OFF	OFF	ON	ON	ON	Adresse 199
ON	ON	OFF	OFF	ON	OFF	OFF	OFF	Adresse 200
ON	ON	OFF	OFF	ON	OFF	OFF	ON	Adresse 201
ON	ON	OFF	OFF	ON	OFF	ON	OFF	Adresse 202
ON	ON	OFF	OFF	ON	OFF	ON	ON	Adresse 203
ON	ON	OFF	OFF	ON	ON	OFF	OFF	Adresse 204
ON	ON	OFF	OFF	ON	ON	OFF	ON	Adresse 205
ON	ON	OFF	OFF	ON	ON	ON	OFF	Adresse 206
ON	ON	OFF	OFF	ON	ON	ON	ON	Adresse 207
ON	ON	OFF	ON	OFF	OFF	OFF	OFF	Adresse 208
ON	ON	OFF	ON	OFF	OFF	OFF	ON	Adresse 209
ON	ON	OFF	ON	OFF	OFF	ON	OFF	Adresse 210
ON	ON	OFF	ON	OFF	OFF	ON	ON	Adresse 211
ON	ON	OFF	ON	OFF	ON	OFF	OFF	Adresse 212
ON	ON	OFF	ON	OFF	ON	OFF	ON	Adresse 213
ON	ON	OFF	ON	OFF	ON	ON	OFF	Adresse 214

CONFIGURATION DE L'ADRESSE (DIP 3)								
SW 8	SW 7	SW 6	SW 5	SW 4	SW 3	SW 2	SW 1	Adresse
ON	ON	OFF	ON	OFF	ON	ON	ON	Adresse 215
ON	ON	OFF	ON	ON	OFF	OFF	OFF	Adresse 216
ON	ON	OFF	ON	ON	OFF	OFF	ON	Adresse 217
ON	ON	OFF	ON	ON	OFF	ON	OFF	Adresse 218
ON	ON	OFF	ON	ON	OFF	ON	ON	Adresse 219
ON	ON	OFF	ON	ON	ON	OFF	OFF	Adresse 220
ON	ON	OFF	ON	ON	ON	OFF	ON	Adresse 221
ON	ON	OFF	ON	ON	ON	ON	OFF	Adresse 222
ON	ON	OFF	ON	ON	ON	ON	ON	Adresse 223
ON	ON	ON	OFF	OFF	OFF	OFF	OFF	Adresse 224
ON	ON	ON	OFF	OFF	OFF	OFF	ON	Adresse 225
ON	ON	ON	OFF	OFF	OFF	ON	OFF	Adresse 226
ON	ON	ON	OFF	OFF	OFF	ON	ON	Adresse 227
ON	ON	ON	OFF	OFF	ON	OFF	OFF	Adresse 228
ON	ON	ON	OFF	OFF	ON	OFF	ON	Adresse 229
ON	ON	ON	OFF	OFF	ON	ON	OFF	Adresse 230
ON	ON	ON	OFF	OFF	ON	ON	ON	Adresse 231
ON	ON	ON	OFF	ON	OFF	OFF	OFF	Adresse 232
ON	ON	ON	OFF	ON	OFF	OFF	ON	Adresse 233
ON	ON	ON	OFF	ON	OFF	ON	OFF	Adresse 234
ON	ON	ON	OFF	ON	OFF	ON	ON	Adresse 235
ON	ON	ON	OFF	ON	ON	OFF	OFF	Adresse 236
ON	ON	ON	OFF	ON	ON	OFF	ON	Adresse 237
ON	ON	ON	OFF	ON	ON	ON	OFF	Adresse 238
ON	ON	ON	OFF	ON	ON	ON	ON	Adresse 239
ON	ON	ON	ON	OFF	OFF	OFF	OFF	Adresse 240
ON	ON	ON	ON	OFF	OFF	OFF	ON	Adresse 241
ON	ON	ON	ON	OFF	OFF	ON	OFF	Adresse 242
ON	ON	ON	ON	OFF	OFF	ON	ON	Adresse 243
ON	ON	ON	ON	OFF	ON	OFF	OFF	Adresse 244
ON	ON	ON	ON	OFF	ON	OFF	ON	Adresse 245
ON	ON	ON	ON	OFF	ON	ON	OFF	Adresse 246
ON	ON	ON	ON	OFF	ON	ON	ON	Adresse 247
ON	ON	ON	ON	ON	OFF	OFF	OFF	Adresse 248
ON	ON	ON	ON	ON	OFF	OFF	ON	Adresse 249
ON	ON	ON	ON	ON	OFF	ON	OFF	Adresse 250
ON	ON	ON	ON	ON	OFF	ON	ON	Adresse 251
ON	ON	ON	ON	ON	ON	OFF	OFF	Adresse 252
ON	ON	ON	ON	ON	ON	OFF	ON	Adresse 253
ON	ON	ON	ON	ON	ON	ON	OFF	Adresse 254
ON	ON	ON	ON	ON	ON	ON	ON	Adresse 255

Tab. 16

Headquarters Italy Videotec S.p.A.

Via Friuli, 6 - I-36015 Schio (VI) - Italy

Tel. +39 0445 697411 - Fax +39 0445 697414

Email: info@videotec.com

Asia Pacific Videotec (HK) Ltd

Flat 8, 19/F. On Dak Industrial Building, No. 2-6 Wah Sing Street

Kwai Chung, New Territories - Hong Kong

Tel. +852 2333 0601 - Fax +852 2311 0026

Email: info.hk@videotec.com

France Videotec France SARL

Immeuble Le Montreal, 19bis Avenue du Québec, ZA de Courtaboeuf

91140 Villebon sur Yvette - France

Tel. +33 1 60491816 - Fax +33 1 69284736

Email: info.fr@videotec.com

Americas Videotec Security, Inc.

Gateway Industrial Park, 35 Gateway Drive, Suite 100

Plattsburgh, NY 12901 - U.S.A.

Tel. +1 518 825 0020 - Fax +1 518 825 0022

Email: info.usa@videotec.com - www.videotec.us



www.videotec.com

MNVCUPTPLUS3_1511_FR



ULISSE PLUS NETCAM

**Outdoor Full IP PTZ-Einheit für Network
Kameras mit mittleren Objektiven**

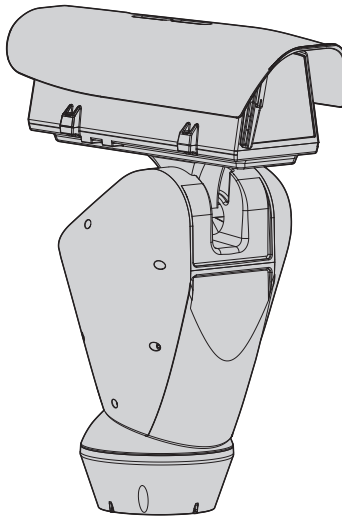

Inhaltsverzeichnis

1 Allgemeines	7
1.1 Schreibweisen.....	7
2 Anmerkungen zum Copyright und Informationen zu den Handelsmarken.....	7
3 Sicherheitsnormen	7
4 Identifizierung	10
4.1 Beschreibung und Bezeichnung des Produktes.....	10
4.2 Kennzeichnung des Produkts.....	10
4.2.1 Prüfung der Kennzeichnung	10
5 Versionen.....	11
5.1 Vorinstallierter Wischer	11
5.2 LED Scheinwerfer.....	11
5.3 Version mit Fensterscheibe aus Germanium	11
6 Vorbereitung des Produktes auf den Gebrauch.....	12
6.1 Sicherheitsvorkehrungen vor dem Gebrauch	12
6.2 Entfernen der Verpackung	12
6.3 Inhalt	12
6.4 Sichere Entsorgung der Verpackungsmaterialien	12
6.5 Auf die Installation vorbereitende Tätigkeiten.....	13
6.5.1 Befestigung der Halterung.....	13
6.5.2 Kabelführung	13
7 Zusammenbau	14
7.6 Montage Kamera und motorisch bewegte Optiken	14
7.6.1 Eigenschaften der Kameras	14
7.6.1 Öffnung des Schutzgehäuse	15
7.6.2 Installation der Kamera	15
7.7 Beschreibung der Karte Gehäuse	16
7.7.1 Anschluss der Kamera und der motorisch bewegten Optik.....	16
7.7.2 Einstellung der Versorgungsspannung der Motoren der Optiken	17
7.7.3 Anschluss der Kommunikationslinie	17
8 Installation	18
8.1 Anschließen der Kabel an die Basis.....	18
8.2 Befestigung der Basis an der Halterung	19
8.3 Beschreibung der Karte Anschlüsse	19
8.4 Anschluss der Stromversorgung.....	20
8.4.1 Anschluss der Stromversorgungslinie 24Vac	21
8.4.2 Anschluss der Versorgungsleitung in 120Vac und 230Vac.....	21
8.4.3 Anschluss der Alarめingänge, der Dämmerungsschalter und der Relais	22
8.5 Anschluss der Ethernet-Netz-Kabel	22
8.6 Befestigung des oberen Körpers.....	23
8.7 Montage der Scheinwerfer mit LED.....	24
8.7.1 Bügelmontage.....	24

8.7.2 Montage des Scheinwerfers auf den Bügel	24
8.8 Anschluss der LED-Scheinwerfer	25
8.9 Trockenmittelbeutel	26
8.10 Einstellung der LED-Scheinwerfer und Vorgehensweise zur Gleichschaltung mit der Kamera..	26
8.10.1 Beschreibung des LED-Scheinwerfers	26
8.10.2 Synchronisierung mit einem externen Dämmerungsschalter	27
8.10.3 Die Einheit mit den LED-Scheinwerfern synchronisieren	27
8.10.4 Manuelle Aktivierung der LED-Scheinwerfer	27
8.10.5 Einstellung der Einschaltsschwelle der LED-Scheinwerfer	28
8.10.6 Einstellung der Leistung der LED-Scheinwerfer	28
8.11 Hardware Konfiguration	29
8.11.1 Öffnen der Konfigurationsklappe	29
8.11.2 Konfiguration der DIP1	29
8.11.3 Konfiguration von DIP2	29
8.11.4 Konfiguration von DIP3	30
8.11.4.1 Adressenkonfiguration	30
8.11.4.2 Die Leitungen der seriellen Datenübertragung konfigurieren	30
8.11.5 Konfiguration von DIP4	30
9 Einschaltung	31
10 Konfiguration	32
10.1 Web-Schnittstelle	32
10.1.1 Erster Zugriff	32
10.1.2 Home	32
10.1.3 Benutzersteuerung	33
10.1.4 Geräteparameter	34
10.1.5 Gerätestatistiken	34
10.1.6 Netzwerk-Konfiguration	34
10.1.7 Benutzer-Konfiguration	35
10.1.8 Bewegungsparameter	35
10.1.8.1 Autopan	36
10.1.8.2 Patrol	36
10.1.8.3 Bewegungsanforderung	36
10.1.9 Preset-Parameter	36
10.1.10 Preset-Parameter (Erweitert)	36
10.1.11 Digitale I/O	37
10.1.12 Washer	37
10.1.13 Kamera-Parameter	38
10.1.14 Werkzeuge	38
10.1.15 Factory Default	39
10.2 VTTunnel	39
11 Zubehör	40
11.1 Waschanlage	40
11.1.1 Anschluss der Waschanlage	40
11.2 Wandhalterung	41
11.3 Halterung für Brüstungsmontage	41
11.4 Netzteil mit Steuerung der Scheinwerfer	41

12 Anleitung für den Sonderbetrieb.....	42
12.1 Den Datenübertragungsmodus bearbeiten (von ONVIF-Protokoll auf serielle Telemetrie)....	42
12.1.1 Verfahren zur Bearbeitung des Datenübertragungsmodus.....	42
13 Wartung.....	43
13.1 Wechsel der Sicherungen.....	43
14 Reinigung.....	43
14.1 Reinigung des Glases und der Kunststoffteile.....	43
14.2 Putzen des Germaniumfensters.....	43
15 Müllentsorgungsstellen.....	43
16 Problemlösung	44
17 Technische Daten.....	45
17.1 Allgemeines.....	45
17.2 Mechanik.....	45
17.3 Elektrik.....	46
17.4 Kommunikation.....	46
17.5 Protokolle.....	46
17.6 Umgebung	46
17.7 Zertifizierungen	46
18 Technische Zeichnungen.....	47
A Anhang - Adressentabelle	50

1 Allgemeines

Lesen Sie bitte vor dem Installieren und dem Verwenden dieses Gerätes die Bedienungsanleitung sorgfältig durch. Bewahren Sie sie zum späteren Nachschlagen auf.

1.1 Schreibweisen



GEFAHR!

Erhöhte Gefährdung.
Stromschlaggefahr. Falls nichts anderes angegeben, unterbrechen Sie die Stromversorgung, bevor die beschriebenen Arbeiten durchgeführt werden.



GEFAHR!

Heiße Oberfläche.
Nicht berühren. Die Oberflächen sind heiß und können bei Berührung zu Verbrennungen führen.



GEFAHR!

Gefahr mechanischer Natur.
Quetsch- oder Scherkantengefahr.



ACHTUNG!

Mittlere Gefährdung.
Der genannte Vorgang hat große Bedeutung für den einwandfreien Betrieb des Systems: es wird gebeten, sich die Verfahrensweise anzulesen und zu befolgen.



ANMERKUNG

Beschreibung der Systemmerkmale.
Eine sorgfältige Lektüre wird empfohlen, um das Verständnis der folgenden Phasen zu gewährleisten.

2 Anmerkungen zum Copyright und Informationen zu den Handelsmarken

Die angeführten Produkt- oder Firmennamen sind Handelsmarken oder eingetragene Handelsmarken.

3 Sicherheitsnormen



ACHTUNG! Die elektrische Anlage, an der die Einheit angeschlossen ist, muss mit einem automatischen zweipoligen Schutzschalter 20A max ausgestattet sein. Dieser Schalter muss vom Typ Listed sein. Zwischen den Kontakten muss mindestens ein Abstand von 3mm vorhanden sein. Der Schalter muss eine Schutzrichtung gegen Erde Fehlerstrom (Differenzial) und gegen Überstrom haben (magnetothermisch).



ACHTUNG! Gefährliche Loseile. Finger und andere Körperteile fernhalten.



ACHTUNG! Die Installation und Wartung der Vorrichtung ist technischen Fachleuten vorbehalten.



ACHTUNG! Damit ein ständiger Brandschutz garantiert wird, sind die Sicherungen nur in dem gleichen Typ und Wert zu ersetzen. Die Sicherungen sind nur von Fachleuten zu ersetzen.



ACHTUNG! Die Anlage gehört zum Typ TNV-1. Nicht an Kreisläufe SELV anschließen.



ACHTUNG! Zur Senkung der Brandgefahr dürfen nur UL Listed oder CSA zertifizierte Kabel benutzt werden, die mindestens der Größe 0.13mm² (26 AWG) entsprechen.

- Der Hersteller lehnt jede Haftung für eventuelle Schäden ab, die aufgrund unsachgemäßer Anwendung der in diesem Handbuch erwähnten Geräte entstanden ist. Ferner behält er sich das Recht vor, den Inhalt ohne Vorkündigung abzuändern. Die Dokumentation in diesem Handbuch wurde sorgfältig ausgeführt und überprüft. Der Hersteller kann dennoch keine Haftung für die Verwendung übernehmen. Dasselbe gilt für jede Person oder Gesellschaft, die bei der Schaffung oder Produktion von diesem Handbuch miteinbezogen ist.

- Unterbrechen Sie die Stromversorgung, bevor die beschriebenen Arbeiten durchgeführt werden.
- Es dürfen keine Kabel mit Verschleiß- oder Alterungsspuren verwendet werden.
- Unter keinen Umständen dürfen Veränderungen oder Anschlüsse vorgenommen werden, die in diesem Handbuch nicht genannt sind. Der Gebrauch ungeeigneten Geräts kann die Sicherheit des Personals und der Anlage schwer gefährden.
- Es dürfen nur Original-Ersatzteile verwendet werden. Nicht originale Ersatzteile können zu Bränden, elektrischen Entladungen oder anderen Gefahren führen.
- Vor der Installation ist anhand des Kennzeichnungsschildes nachzuprüfen, ob das gelieferte Material die gewünschten Eigenschaften (4.2 Kennzeichnung des Produkts, Seite 10).
- Die Einrichtung ist für den dauerhaften Einbau in ein Gebäude oder eine andere geeignete Struktur konzipiert. Vor jeder Operation muss die Einrichtung dauerhaft eingebaut werden.
- Die Installationskategorie (auch als Überspannungskategorie bezeichnet) gibt den Pegel der Netzspannungsstöße an, denen die Ausrüstung ausgesetzt ist. Die Kategorie hängt vom Installationsort der Ausrüstung und von den externen Schutzeinrichtungen gegen Spannungsstöße ab. Ausrüstungen in einer gewerblichen Umgebung, die direkt mit den Hauptzweigen der Versorgungsanlage verbunden sind, gehören zur Installationskategorie III. In diesem Fall ist eine Abstufung auf Installationskategorie II erforderlich. Dies kann durch den Einsatz eines Isoliertransformators mit einem geerdeten Schirm zwischen Primär- und Sekundärwicklung erreicht werden. Alternativ können UL-gelistete Überspannungsschutzvorrichtungen (SPD) von Fase zu Nullleiter und von Nullleiter zur Erde geführt werden. UL-gelistete Überspannungsschutzvorrichtungen sind für die wiederholte Begrenzung kurzzeitig auftretender Spannungsspitzen und für die folgenden nominellen Betriebsbedingungen auszulegen: Typ 2 (Dauerhaft angeschlossene Überspannungsschutzvorrichtungen für die Installation auf der Ladungsseite der Hilfseinrichtung); Nennladestrom (I_n) 20kA min. Benutzt werden können beispielsweise: FERRAZ SHAWMUT, STT2240SPG-CN, STT2BL240SPG-CN, spezifiziert für 120Vac/240Vac, ($I_n=20kA$). Der maximale Abstand zwischen dem Einbau und der Abkürzung ist 5m.
- Lediglich für die Produkte mit UL - Markierung mit 24Vac - Versorgung ein UL - Speisetransformator der Klasse 2 verwenden, welches den geltenden Richtlinien entspricht.
- Eine sofort und problemlos zugängliche Abtrennvorrichtung muss in die Elektroanlage des Gebäudes eingebaut werden, um einen schnellen Eingriff zu garantieren.
- Der im Gerät verfügbare Erdungsanschluss muss ständig geerdet sein.
- Vorgeschrieben ist der Anschluss an eine Versorgungsquelle, deren Eigenschaften den Angaben auf dem Kennzeichnungsschild entsprechen. Vor der Installation ist zu prüfen, ob die Stromleitung sachgerecht abgetrennt ist. Die Versorgungsspannung darf die Toleranzen ($\pm 10\%$) nicht überschreiten.
- Die Vorrichtung mit einer isolierten Quelle Typ SELV 24Vac, 8A versorgen, von einem Transformator mit doppelter Isolierung UL Listed kommend, der entsprechend am Ausgang geschützt ist.
- Die Einrichtung ist so zu montieren, dass sie für keine andere Person als den Techniker oder Installateur zugänglich ist. Da sie mit beweglichen Teilen ausgestattet ist, bleibt ein Restrisiko, sich an den Bewegungselementen zu verletzen.
- Bringen Sie das Schildchen Gefährliche Bewegungsteile in der Nähe der Einrichtung an. (Abb. 5, Seite 12).
- Das Gerät nicht in der Nähe entzündlicher Stoffe benutzen.
- Für den Anschluss der Versorgungsleitung den entsprechenden Anschlusskasten verwenden (UPTJBUL). Für weitere Informationen siehe Bedienungs- und Installationshandbuch des Produktes.

- Kindern oder unbefugten Personen ist der Gebrauch des Gerätes zu untersagen.
- Das Gerät gilt erst dann als deaktiviert, wenn die Stromversorgung ausgeschaltet und die Verbindungskabel zu den anderen Einrichtungen entfernt worden sind.
- Die Wartung der Einrichtung ist Fachleuten vorbehalten. Während der Wartungsarbeiten ist die tätige Person der Gefahr von Stromschlägen und anderen Gefahren ausgesetzt.
- Verwenden Sie nur vom Hersteller empfohlenes Zubehör. Jede vom Hersteller nicht ausdrücklich genehmigte Veränderung führt zum Verfall der Gewährleistungsrechte.
- Vor dem Anschluss sämtlicher Signalkabel ist zu prüfen, ob die Einrichtung sachgerecht mit dem Erdungskreis verbunden ist.
- Wenn die Einrichtung von der Anlage getrennt werden muss, ist das Erdungskabel stets zuletzt abzuklemmen.
- Vermeiden Sie durch gebotene Vorkehrungen, dass das Gerät durch elektrostatische Entladungen beschädigt wird.
- Die Einheit ist dafür ausgelegt, über ein dreipoliges Kabel angeschlossen zu werden. Folgen Sie den Anleitungen in diesem Handbuch für den korrekten Anschluss des Erdungskreises.
- Die Einrichtung ist vorsichtig zu handhaben, starke mechanische Beanspruchungen könnten sie beschädigen.
- Achten Sie besonders auf die Isolierabstände zwischen der Versorgungsleitung und allen anderen Kabeln einschließlich der Vorrichtungen zum Schutz gegen Blitzeinschlag.
- Die Einrichtung darf nur mit größter Vorsicht transportiert werden. Ruckartige Haltemanöver, Höhenunterschiede und starke Aufpralle können das Objekt schädigen oder den Benutzer verletzen.

4 Identifizierung

4.1 Beschreibung und Bezeichnung des Produktes

ULISSE PLUS NETCAM ist eine leistungsstarke Full-IP PTZ für Außenanwendungen von IP-Videoüberwachungen, die die modernen Videokameras IP SD, HD und Megapixel verwalten kann und sich in ein Network-System einfügt.

Dieses Modell kann Videokameras mit mittelgroßen Objektiven aufnehmen und erlaubt die dynamische und Nonstop-Überwachung von 360°-Außenbereichen.

Die Besonderheit von ULISSE PLUS NETCAM besteht in der Möglichkeit, auf einfache Weise über das Netz alle Funktionen der Videokamera und des Schwenk-Neige-Kopfes (einschließlich Scheibenwischer, Preset und Set-up) mit dem Großteil der auf dem Markt erhältlichen VMS kontrollieren zu können. Es können alle Videokameras verwendet werden, die mit ONVIF-Protokoll, S-Profil oder einer RS-485-Schnittstelle kompatibel sind, während die gesamte Systemsteuerung nur eine IP Adresse benötigt.

Die Einheit ist mit einem Scheibenwischer für die Reinigung der Frontscheibe von Regen und Staub ausgerüstet; es ist eine große Auswahl an Kanistern mit Scheibenwaschpumpe mit unterschiedlichen Fassungsvermögen und Förderhöhen erhältlich.

Um detaillierte Bilder auch in der Nacht zu garantieren, sind Versionen mit LED- und Infrarotscheinwerfern oder mit Scheinwerfern mit weißem Licht erhältlich.

Die sorgfältige Topmount-Konstruktion erlaubt die Sicht über den Horizont hinaus und die kontinuierliche Rotation auf der horizontalen Achse und verbindet hohe Geschwindigkeit mit einer absoluten Ausrichtungsgenauigkeit im manuellen Betrieb und auch beim Rundgang.

Die Einheit ist mit optischen Sensoren ausgestattet, die die genaue Kontrolle der Position unter jeder Verwendungsbedingung garantieren.

4.2 Kennzeichnung des Produkts



Auf den Schwenk-Neige-Köpfen befindet sich ein Schildchen, das der CE-Kennzeichnung entspricht.



Abb. 1

Das Schildchen nennt:

- Identifizierungscode des Modells (Strichcode Extended 3/9).
- Versorgungsspannung (Volt).
- Frequenz (Hertz).
- Stromaufnahme (Ampere).
- Schutzart (IP).
- Seriennummer.

4.2.1 Prüfung der Kennzeichnung

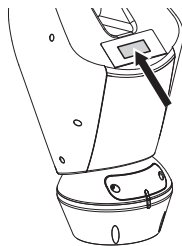
Vor Beginn der Installationsarbeiten ist zu kontrollieren, ob das gelieferte Material den jeweiligen Anforderungen entspricht. Zu erkennen ist dies anhand der Kennzeichnungsschilder.

Unter keinen Umständen dürfen Veränderungen oder Anschlüsse vorgenommen werden, die in diesem Handbuch nicht genannt sind. Der Gebrauch ungeeigneten Geräts kann die Sicherheit des Personals und der Anlage schwer gefährden.

5 Versionen

5.1 Vorinstallierter Wischer

Das Produkt kann mit einem Scheibenwischer ausgestattet sein.



Abb. 2

i Für weitere Infos bitte entsprechendes Kapitel beachten (10.1.3 Benutzersteuerung, Seite 33).

Der Schwenk-Neige-Kopf muss mit einer externen Pumpe ausgestattet sein, die Wasser für die Reinigung des Glases liefert.

i Für weitere Infos bitte entsprechendes Kapitel beachten (11.1 Waschanlage, Seite 40).

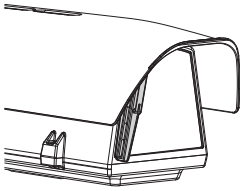
5.2 LED Scheinwerfer

! Die Version mit LED- Scheinwerfern kann nur mit einer Spannung von 24Vac betrieben werden.

Der S-N-Kopf kann mit einer Halterung für 2 VIDEOTEC LED- Scheinwerfer für die Nachtüberwachung (Scheinwerfer nicht eingeschlossen).



Abb. 3

i Für weitere Infos bitte entsprechendes Kapitel beachten (8.7 Montage der Scheinwerfer mit LED, Seite 24).

5.3 Version mit Fensterscheibe aus Germanium

Die Version ist mit Fensterscheibe aus Germanium ausgestattet, die eigens für Anlagen mit Wärmebildkameras ausgelegt ist.

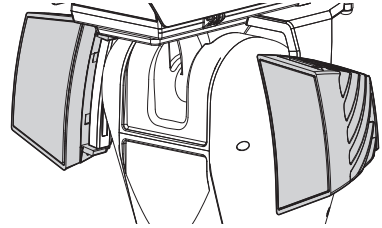



Abb. 4

6 Vorbereitung des Produktes auf den Gebrauch

 **Jede vom Hersteller nicht ausdrücklich genehmigte Veränderung führt zum Verfall der Gewährleistungsrechte.**

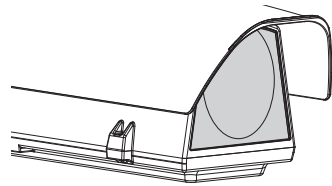
 **Die Einheit darf nicht auseinandergebaut werden, und es dürfen keine Veränderungen daran vorgenommen werden. Ausnahmen sind nur die Montage- und Wartungsarbeiten, die laut dieser Anleitung vorgesehen sind.**

6.1 Sicherheitsvorkehrungen vor dem Gebrauch

 **Das Gerät umfasst bewegliche Teile. Stellen Sie sicher, dass die Einheit an einer Stelle positioniert wird, die unter normalen Betriebsbedingungen nicht zugänglich ist. Bringen Sie das im Lieferumfang des Gerätes enthaltene Schildchen in der Nähe des Objektes an gut sichtbarer Stelle an.**



Abb. 5

6.2 Entfernen der Verpackung

Bei der Lieferung des Produktes ist zu prüfen, ob die Verpackung intakt ist oder offensichtliche Anzeichen von Stürzen oder Abrieb aufweist.

Bei offensichtlichen Schadensspuren an der Verpackung muss umgehend der Lieferant verständigt werden.

Bewahren Sie die Verpackung auf für den Fall, dass das Produkt zur Reparatur eingeschendet werden muss.

 **Die Haube der Vorrichtung Einrichtung vorsichtig auspacken, damit das Gehäuse keinen Schaden nimmt.**

6.3 Inhalt

Prüfen Sie, ob der Inhalt mit der nachstehenden Materialliste übereinstimmt:

- Positionierungseinheit
- Basis für Netzstromversorgung
- Zubehör Packung:
 - Serieller Adapter
 - Seriellles Verlängerungskabel
 - Innensechskantschlüssel
 - Abstandsstücke (nicht vorhanden bei der Version mit integrierter Videokamera)
- Schildchen
- Kabelbinder
- Silikonummantelung
- Reduzierdichtungen für Kabelverschraubungen
- Bedienungsanleitung
- Befestigungsplatte für Beutelchen (nicht vorhanden bei den Versionen mit LED-Scheinwerfern)
- Trockenmittelbeutel
- Schrauben
- Befestigungsbügel für LED-Scheinwerfer (vorhanden bei den Versionen mit LED-Scheinwerfern)
- Sonnenschutzdach

6.4 Sichere Entsorgung der Verpackungsmaterialien

Die Verpackungsmaterialien sind vollständig wiederverwertbar. Es ist Sache des Installationstechnikers, sie getrennt, auf jeden Fall aber nach den geltenden Vorschriften des Anwendungslandes zu entsorgen.

Im Falle der Rückgabe des nicht korrekt funktionierenden Produktes empfiehlt sich die Verwendung der Originalverpackung für den Transport.

6.5 Auf die Installation vorbereitende Tätigkeiten

6.5.1 Befestigung der Halterung

Verschiedene Halterungen sind (11 Zubehör, Seite 40). Das geeignetste für die Installation auswählen und alle Angaben aus diesem Kapitel befolgen.

! Besondere Aufmerksamkeit verlangen die Befestigungssysteme des Gerätes. Das Befestigungssystem muss in jedem Fall in der Lage sein, mindestens das 4 fache Gewicht der gesamten Apparatur mitsamt S-N-Kopf, Linsen und Kamera zu tragen.

! Die Einrichtung muss in senkrechter Lage montiert werden. Jede andere Stellung könnte die Leistungen des Gerätes beeinträchtigen.

! Den Schwenk-Neige-Kopf nicht umgekehrt montieren.

6.5.2 Kabelführung

! Die Verbindungskabel dürfen von außen nicht zugänglich sein. Die Kabel müssen gegen Lösen durch Abziehen sachgerecht am Träger fixiert werden, damit es verhindert wird, dass es durch das hohe Gewicht unbeabsichtigt abgezogen wird.

! Die verwendeten Kabel müssen der Anlagenart angemessen sein.

Die Kabel so in die Halterung einführen, dass sie ungefähr 50cm hervorschauen.



Abb. 6

7 Zusammenbau

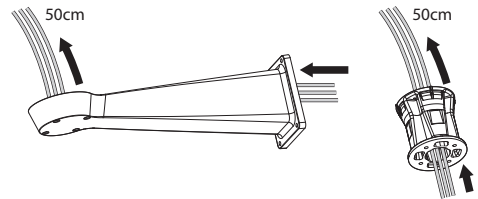

Nur Netzwerk-Kameras mit bestimmten technischen Eigenschaften können installiert werden (7.6.1 Eigenschaften der Kameras, Seite 14).

7.6 Montage Kamera und motorisch bewegte Optiken



Der korrekte Betrieb des Gerätes innerhalb des angezeigten Temperaturbereichs ist nur garantiert, wenn die Temperaturschwellen der verwendeten Kamera und Optik mindestens zwischen -10°C und + 60°C liegen.

Die Kamera und die zugehörigen Objektive sind vom Kunden selbst zu montieren.

7.6.1 Eigenschaften der Kameras



Der korrekte Betrieb des Gerätes innerhalb des angezeigten Temperaturbereichs ist nur garantiert, wenn die Temperaturschwellen der verwendeten Kamera und Optik mindestens zwischen -10°C und + 60°C liegen.



Die Videokamera muss vor-konfiguriert werden, um die IP-Adresse mit DHCP erfassen zu können.



Die Kamera muss vorkonfiguriert sein, um mit dem NTP-Server über DHCP-Schnittstelle verbunden werden zu können. Wenn die NTP-Konfiguration mit DHCP nicht möglich ist, muss die folgende statische Adresse des NTP-Servers eingegeben werden. 192.0.0.1.



In der Einheit können nur Netzwerkkameras installiert werden.

- Nur Kameras mit Ethernet-Kommunikationsanschluss vom Typ 100 baseTx können montiert werden.
- Nur solche Kameras können montiert werden, die über Klemme mit Strom versorgt werden. Der Schwenk-Neige-Kopf ist nämlich nicht in der Lage, direkt über das Ethernetkabel Strom bereitzustellen (Power over Ethernet).
- Die Versorgungsspannung der Kamera muss 12Vdc betragen.
- Die maximale Stromaufnahme der Kamera muss unter 800mA liegen.
- Das Kommunikationsprotokoll muss ONVIF, S-Profil, sein. Die Videokamera muss für einen Datenaustausch mit dem ONVIF, S-Profil, Protokoll vor-konfiguriert werden.
- Der Betriebstemperaturbereich der Kamera muss zwischen -10°C und +60°C liegen.

7.6.1 Öffnung des Schutzgehäuse

Zum Öffnen des Gehäuses die Schrauben auf der Seiten abschrauben und den oberen Körper solange erhöhen.



Abb. 7



Nach der Entfernung des oberen Gehäuseteils ist dieses begleitend zu führen, bis das Verankerungskabel gespannt ist. Das obere Gehäuseteil nicht fallen lassen, denn durch das Gewicht könnte das Kabel reißen.

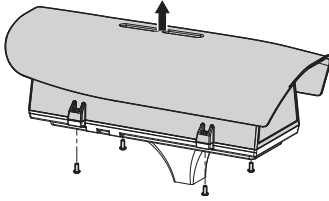

Nach Beendigung der Installation und der Verkabelung das Produkt wieder schließen.

7.6.2 Installation der Kamera

Den internen Auflageschlitten (01) herausziehen, indem man die Befestigungsschrauben löst (02). Befestigen Sie die Kamera mit der 1/4"-Schraube (03). Den Innenschlitten so einstellen, dass Optik und Kamera korrekt positioniert sind.

Den verstellbaren Schlitten mit den zugehörigen Schrauben in der richtigen Position feststellen. Für die Positionierung der Videokamera können auch die Abstandhalter verwendet werden, die im Lieferumfang enthalten sind (04).



Abb. 8

Den internen Schlitten wieder an Ort und Stelle bringen und die zuvor gelockerten Schrauben festziehen.

7.7 Beschreibung der Karte Gehäuse

BESCHREIBUNG DER KARTE	
Verbinder/Klemme	Funktion
CN1	Nicht verwendet.
CN2	Steckverbinder Steuerung Motoren motorbetriebene Optiken
CN3	Steckverbinder Potenziometer motorbetriebene Optiken
CN6	Nicht verwendet.
CN7	Kamera Stromversorgung, Zusatzleitungen
DIP1	Auswahl der Versorgungsspannung der Optiken.

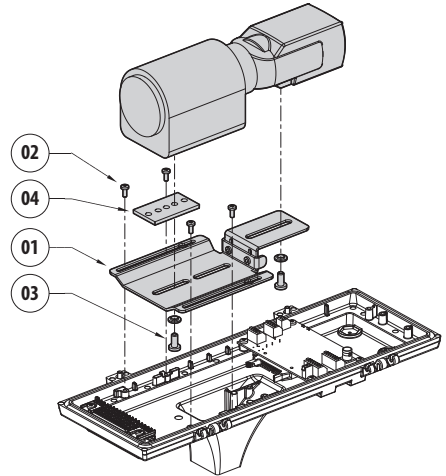
Tab. 1



Abb. 9

7.7.1 Anschluss der Kamera und der motorisch bewegten Optik

! Alle nachstehend erläuterten Anschlüsse dürfen nur von Fachleuten ausgeführt werden und müssen den Anforderungen entsprechen, die hinsichtlich der Verdrahtung und Speisung der Einrichtungen bestehen.

Die elektronische Platine ist zur Steuerung von Kameras mit solchen motorgeführten Optiken ausgelegt (Focus, Iris, Zoom), welche Potentiometer für die Positionsteuerung besitzen oder nicht.

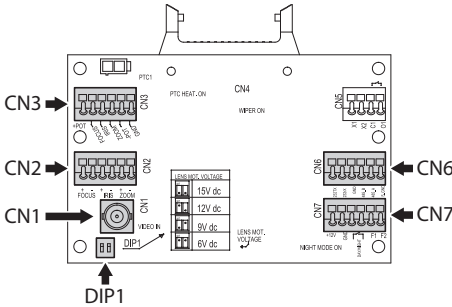
Bevor die Anschlüsse vorgenommen werden, ist zu prüfen, ob die von der Platine bereitgestellten Spannungswerte innerhalb der für das Gerät geltenden Grenzwerte liegen.

ANSCHLUSS KAMERA/MOTORISCH BEWEGTE OPTIK		
Spannung	Strom	Beschreibung
+12V	800mA max	Kamera Stromversorgung
+5V	15mA max	Speisung Potentiometer zur Regelung der Optiken
Von 6Vdc bis zu 15Vdc (einstellbar)	200mA max (Focus+Zoom+Iris)	Speisung Antriebsmotoren der Optiken

Tab. 2

Optiken mit Motoren mit gemeinsamem Leiter: Den Anschluss wie in der Abbildung gezeigt ausführen..

Für die Versorgung der Videokamera müssen die Anschlüsse wie in der Abbildung dargestellt ausgeführt werden.



Abb. 10 CN2.



Abb. 11 CN7.

Optiken mit Motoren mit umgekehrter Polarität:

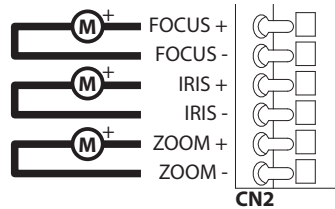
Den Anschluss wie in der Abbildung gezeigt ausführen..

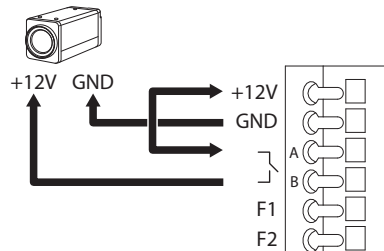

Abb. 12 CN2.

Optiken mit Motoren mit gemeinsamem Leiter:

Die entsprechende Option im Menü aktivieren. (10.1.13 Kamera-Parameter, Seite 38). Den Anschluss wie in der Abbildung gezeigt ausführen..

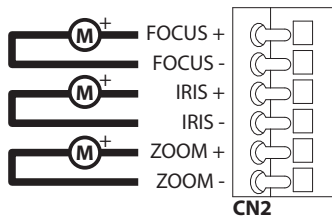

Abb. 13 CN2.

Potentiometer: Den Anschluss wie in der Abbildung gezeigt ausführen..

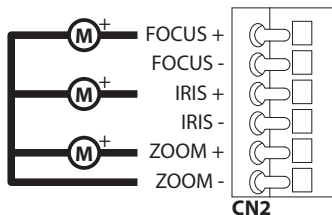

Abb. 14 CN3.

7.7.2 Einstellung der Versorgungsspannung der Motoren der Optiken

Bevor die Stromversorgung des Schwenk-Neige-Kopfes hergestellt wird, ist die Versorgungsspannung der Optiken mithilfe von DIP1 wählen (7.7 Beschreibung der Karte Gehäuse, Seite 16).

EINSTELLUNG DER VERSORGUNGSSPANNUNG DER MOTOREN DER OPTIKEN		
SW1	SW2	Spannung
OFF	OFF	15Vdc
ON	OFF	12Vdc
OFF	ON	9Vdc
ON	ON	6Vdc

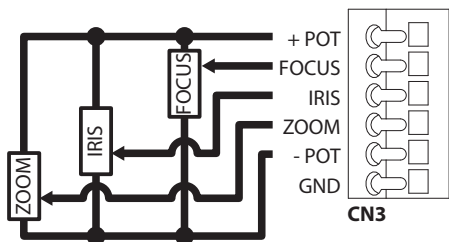
Tab. 3

7.7.3 Anschluss der Kommunikationslinie

Anschluss des Ethernet-Kabels an die Videokamera.



Abb. 15

i Das überschüssige Kabel aufwickeln, um Interferenzen mit dem Betrieb des Scheibenwischers zu verhindern. (bei den Versionen, die damit ausgestattet sind).

8 Installation

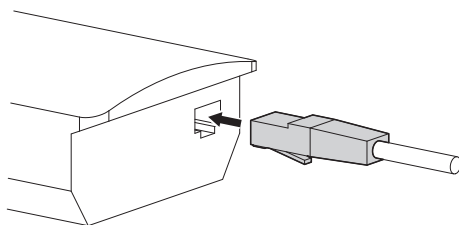

Unter keinen Umständen dürfen **Veränderungen oder Anschlüsse vorgenommen werden, die in diesem Handbuch nicht genannt sind. Die Missachtung der Angaben, die das Handbuch zu den Anschlüssen macht, kann die Sicherheit von Personen und die Sicherheit der Anlage stark gefährden.**



Die **Vorverkabelungen des Produktes dürfen nicht verändert werden. Die Missachtung dieses Verbotes kann die Sicherheit des Personals und der Anlage stark gefährden und führt sie zum Verlust der Gewährleistungsrechte.**



Falls das **Scheibenreinigungsset** verwendet wird, muss die Halterung für die Düse vor der Positionierung des Schwenk-Neige-Kopfes und der Kabel installiert werden. Weitere Informationen können dem Handbuch des Bausatzes entnommen werden.



Abb. 16



Im Innern der unteren Haube befindet sich ein Beutelchen, das der Bildung von Feuchtigkeit in der Basis und an den Anschlussplatinen entgegenwirkt. Den Beutel vor der Installation entfernen.

8.1 Anschließen der Kabel an die Basis

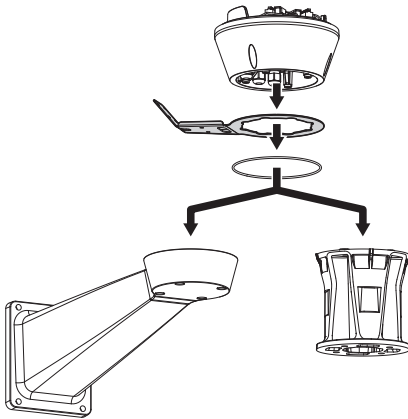
Die Kabel in den Kabelschellen einführen, während die Basis etwa 20cm von der Halterung entfernt gehalten wird. Die Kabelverschraubungen festziehen. Alle Kabelverschraubungen sind für Kabel mit einem Durchmesser von 5mm bis 10mm geeignet.



Abb. 17



Auf die Befestigung achten. Anzugsdrehmoment: 5Nm.

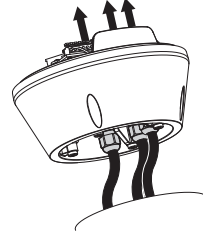

Für Kabel mit Durchmesser von 3mm bis 7mm die im Lieferumfang enthaltenen Gummidichtungen benutzen.



Abb. 18

8.2 Befestigung der Basis an der Halterung

⚠ Verwenden Sie die mit der Basis gelieferten Schrauben und Unterlegscheiben.

Nach der Positionierung der Dichtung (01), die Basis (02) mit den Schrauben (04), den Zahnscheiben (05) und den Ringen für Schrauben (06) an der Halterung (03) befestigen.

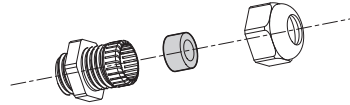

Abb. 19



Abb. 20

Die 3 Markierungen auf der Basis an den Markierungen auf den Halterungen ausrichten, wie in der folgenden Abbildung dargestellt.

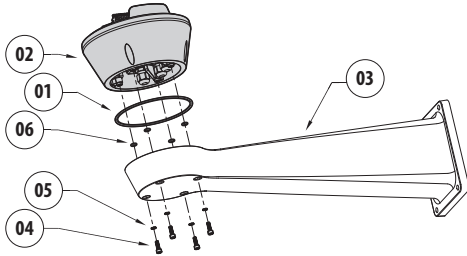

Abb. 21

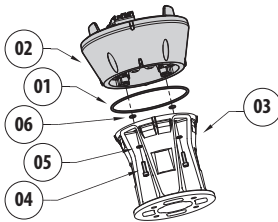
⚠ Auf das Loch der Schrauben ein Gewindegewissungsmittel auftragen (Loctite 243®).

⚠ Auf die Befestigung achten. Anzugsdrehmoment: 4Nm.

8.3 Beschreibung der Karte Anschlüsse

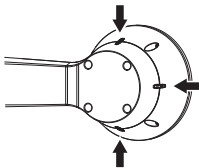
BESCHREIBUNG DER KARTE ANSCHLÜSSE

Verbinder/ Komponente	Funktion
CN1	Platinenversorgung
CN4	Signalkabel
Ethernet	Ethernet
F1	Sicherung
F2	Sicherung

Tab. 4



Abb. 22

8.4 Anschluss der Stromversorgung

Je nach Version kann die Vorrichtung mit unterschiedlichen Versorgungsspannungen geliefert werden. Der Wert ist auf dem Kennzeichnungsschild des Produktes angegeben (4.2 Kennzeichnung des Produkts, Seite 10).

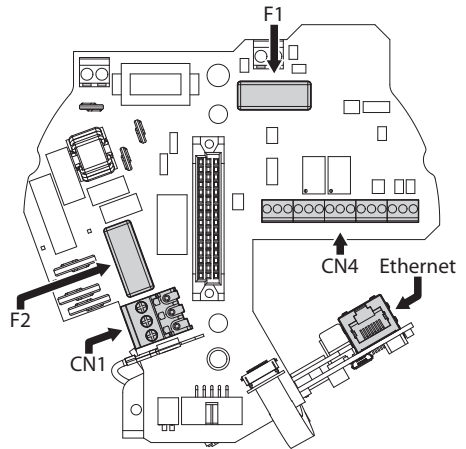

Die elektrischen Anschlüsse nur durchführen, wenn die Stromversorgung abgetrennt und die Trennvorrichtung offen ist.



Im Zuge der Installation ist zu prüfen, ob die Merkmale der von der Anlage bereitgestellten Versorgung mit den erforderlichen Merkmalen der Einrichtung übereinstimmen.



Es ist zu prüfen, ob die Versorgungsquellen und die Anschlusskabel für den Systemverbrauch ausgelegt sind.



Das Erdungskabel muss um etwa 10mm länger sein, als die anderen beiden Kabel, um das ungewollte Lösen durch Ziehen des Kabels zu verhindern.



Ferner muss das Versorgungskabel von einer Silikonummantelung (01) überzogen sein, die im Lieferumfang enthalten ist. Die Silikonummantelung soll mit dem zugehörigen Binder fixiert werden (02).



Abb. 23

8.4.1 Anschluss der Stromversorgungsleitung 24Vac

⚠ Lediglich für die Produkte mit UL - Markierung mit 24Vac - Versorgung ein UL - Speisetransformator der Klasse 2 verwenden, welches den geltenden Richtlinien entspricht.

Die Kabel zuschneiden und die unten beschriebenen Anschlüsse vornehmen. Die Versorgungsleitung am Klemmen anschließen: CN1.

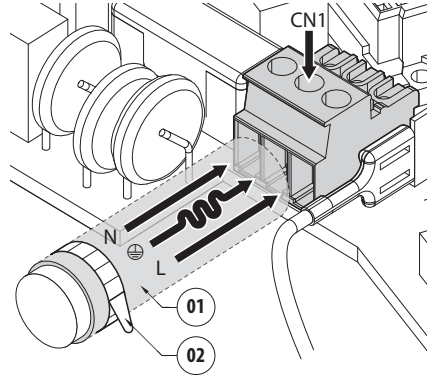

Abb. 24

Die Versorgungskabel sind nach der folgenden Tabelle anzuschließen.

ANSCHLUSS DER STROMVERSORGUNG	
Farbe	Klemmen
Stromversorgung 24Vac	
Vom Installateur festgelegt.	24Vac
Vom Installateur festgelegt.	24Vac
Gelb/Grün	⊕

Tab. 5

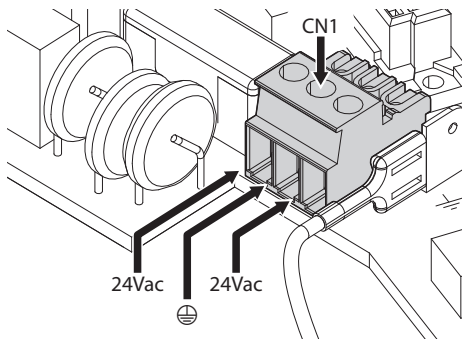
8.4.2 Anschluss der Versorgungsleitung in 120Vac und 230Vac

Die Kabel zuschneiden und die unten beschriebenen Anschlüsse vornehmen. Die Versorgungsleitung am Klemmen anschließen: CN1.



Abb. 25

Die Versorgungskabel sind nach der folgenden Tabelle anzuschließen.

ANSCHLUSS DER STROMVERSORGUNG	
Farbe	Klemmen
Netzteil 230Vac	
Blau	N (Nullleiter)
Braun	L (Phase)
Gelb/Grün	⊕
Netzteil 120Vac	
Blau	N (Nullleiter)
Braun	L (Phase)
Gelb/Grün	⊕

Tab. 6

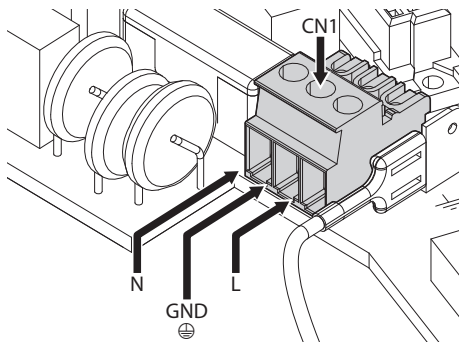
8.4.3 Anschluss der Alarmeingänge, der Dämmerungsschalter und der Relais



ACHTUNG! Die Anlage gehört zum Typ TNV-1. Nicht an Kreisläufe SELV anschließen.



ACHTUNG! Zur Senkung der Brandgefahr dürfen nur UL Listed oder CSA zertifizierte Kabel benutzt werden, die mindestens der Größe 0.13mm² (26 AWG) entsprechen.

Standardmodell



Abb. 26 Anschluss der Relaiskontakte.



Abb. 27 Anschluss der Alarme.

Version mit LED- Scheinwerfern

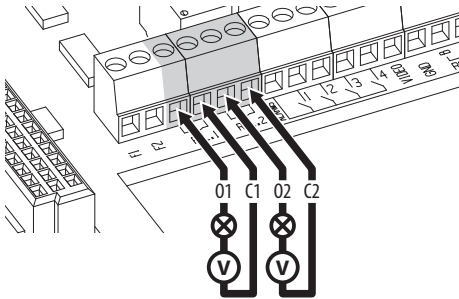
ANSCHLUSS DER ALARMEINGÄNGE, DER DÄMMERUNGSSCHALTER UND DER RELAIS

AL1, AL2, AL3, AL4 e AGND	Sich selbstversorgende Alarmeingänge, bezogen auf gemeinsame Klemme AGND.
O1-C1 e O2-C2	Potentialfreie Ausgangskontakte, die durch Alarm oder Benutzerbefehl ansprechbar sind

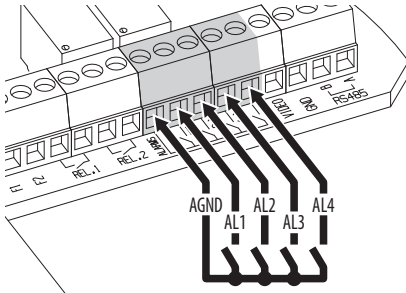
Tab. 7



Anschluss des Dämmerungsschalters an die Klemmen AGND und AL1. Der Kontakt des Alarms AL1 ist standardmäßig auf die Dämmerungsschalter ausgerichtet.

8.5 Anschluss der Ethernet-Netz-Kabel

Das Ethernetkabel am Verbinder anschließen (8.3 Beschreibung der Karte Anschlüsse, Seite 19).



Abb. 28

8.6 Befestigung des oberen Körpers

Den oberen Körper (01) mit den Spannschrauben (03) und Dichtungen (04) an der Basis (02) befestigen. Prüfen Sie, ob die Dichtung (05) der Basis vorhanden und in einwandfreiem Zustand ist.

**⚠ Auf die Befestigung achten.
Anzugsdrehmoment: 4Nm.**

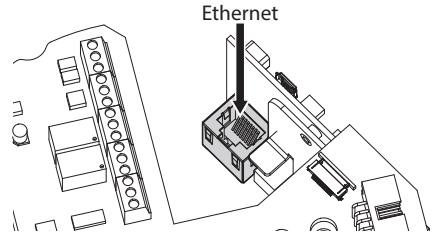

Abb. 29



Abb. 30

i Es gibt nur eine Verankerungsposition zwischen der Basis und dem oberen Körper. Die Seitenvorsprünge für eine korrekte Positionierung ausrichten.

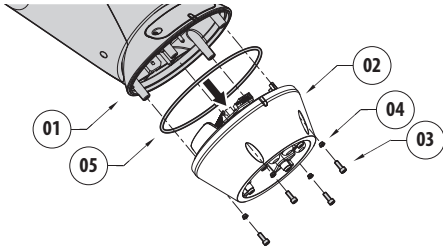
8.7 Montage der Scheinwerfer mit LED

! Aus funktionstechnischen Gründen müssen stets beide Scheinwerfer zusammen montiert werden.

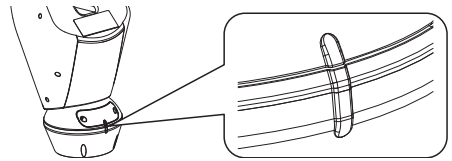
i Am Schwenk-Neige-Kopf dürfen nur Scheinwerfer von VIDEOTEC installiert werden.

8.7.1 Bügelmontage

Den Bügel (01) im unteren Teil des Gehäuses positionieren, wie in der Abbildung gezeigt. Die Schrauben und die Unterlegescheiben (02) in die Bohrungen (03) einfügen und festziehen. Auf festen Halt prüfen. Keine Materialien benutzen, die nicht im Lieferumfang des Bausatzes enthalten sind.



Abb. 31

! Auf die Befestigung achten.
Anzugsdrehmoment: 4Nm.

8.7.2 Montage des Scheinwerfers auf den Bügel

Befestigungen des Scheinwerfers (01) an denen des Bügels (02) anbringen.

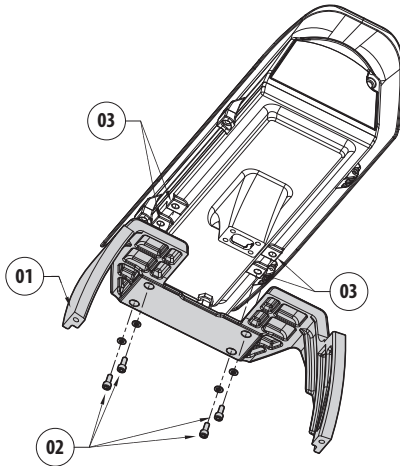

Abb. 32

Die zuvor demontierten Schrauben mit den Unterlegescheiben wieder festziehen.

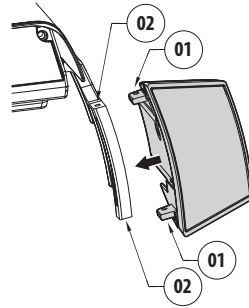

Abb. 33

! Auf die Befestigung achten.
Anzugsdrehmoment: 6Nm.

8.8 Anschluss der LED-Scheinwerfer

Das Gehäuse öffnen wie beschrieben (Abb. 7, Seite 15).

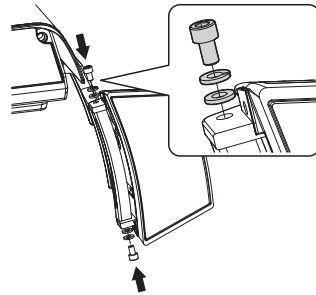
Die Versorgungskabel um mindestens 25 cm durch die Kabelschellen stecken.



Abb. 34

! Damit die Sicherheit und die gute Funktion der Einheit nicht beeinträchtigt wird, keinen Kabelüberschuss lassen.



Die Kabel so anschließen, wie in der Abbildung gezeigt.

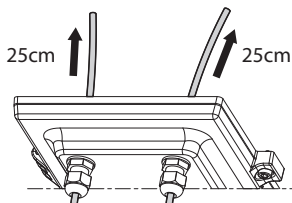
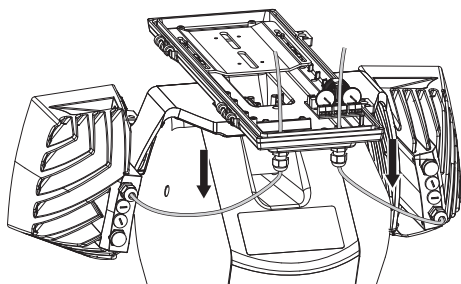

Abb. 35

ANSCHLUSS DER LED-SCHEINWERFER

Rechter Scheinwerfer		Linker Scheinwerfer	
Bezug auf die Karte	Kabelfarbe	Bezug auf die Karte	Kabelfarbe
WH	Weiß	WH	Weiß
BK	Schwarz	BK	Schwarz
A1	Grün	A2	Grün
B1	Rot	B2	Rot

Tab. 8

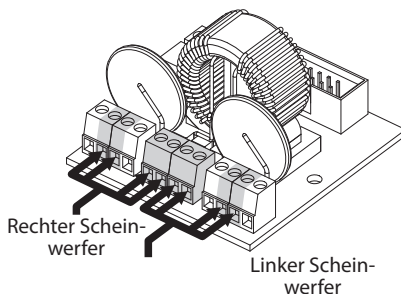
8.9 Trockenmittelbeutel

Das Beutelchen mit dem zugehörigen Bügel fixieren.



Abb. 36



Abb. 37 Vorhanden bei den Versionen mit LED-Scheinwerfern.

8.10 Einstellung der LED-Scheinwerfer und Vorgehensweise zur Gleichschaltung mit der Kamera

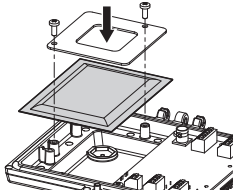

Nach der Regelung synchronisiert und steuert der linke Scheinwerfer (MASTER) den rechten Scheinwerfer (SLAVE).

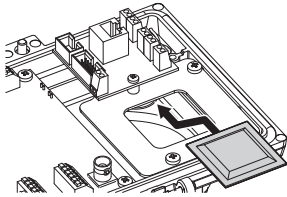
Der Dämmerungsschalter ermittelt das Licht in der Umgebung und kontrolliert das Ein- und Ausschalten der Scheinwerfer, wenn die Helligkeit das vom Benutzer eingestellte Niveau erreicht hat.

Wenn die LED-Scheinwerfer aktiviert sind, geht die Videokamera mit der entsprechenden Steuerung ONVIF in Nacht-Modus über.

8.10.1 Beschreibung des LED-Scheinwerfers



Um die Sicherheit und die Funktion des Beleuchters nicht zu beeinträchtigen, soll der durchsichtige Schrauben des Dämmerungssensors nicht entfernt werden.

- **Dämmerungssensor:** Erfasst den Helligkeitsgrad.
- **Kabel:** Versorgung und Steuerung.
- **Regler der Einschaltung-Grenze:** Das Potenziometer regelt den Empfindlichkeitsgrad für die Einschaltung des Scheinwerfers.
- **Regler der Infrarot-Stärke:** Das Potenziometer regelt die Leistung des Scheinwerfers.



Abb. 38

8.10.2 Synchronisierung mit einem externen Dämmerungsschalter

Die Scheinwerfer und die Kamera werden folgendermaßen mit einem externen Dämmerungsschalter synchronisiert:

- Anschluss des Dämmerungsschalters an die Klemmen: AL1/AGND (8.4.3 Anschluss der Alarmeingänge, der Dämmerungsschalter und der Relais, Seite 22).
- Den linken Scheinwerfer einstellen. (MASTER):
 - **Einschaltschwelle:** Den Wert auf OFF stellen. (8.10.5 Einstellung der Einschaltsschwelle der LED-Scheinwerfer., Seite 28).
 - **Infrarotleistung:** Wert entsprechend dem Bedarf einstellen (8.10.6 Einstellung der Leistung der LED-Scheinwerfer., Seite 28).
- Regelung des rechten Scheinwerfers (SLAVE):
 - **Einschaltschwelle:** Wert auf Maximum einstellen (8.10.5 Einstellung der Einschaltsschwelle der LED-Scheinwerfer., Seite 28).
 - **Infrarotleistung:** Wert auf Minimum einstellen (8.10.6 Einstellung der Leistung der LED-Scheinwerfer., Seite 28).

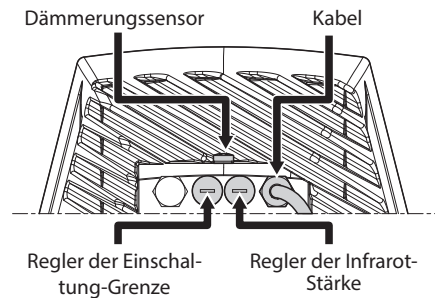
Über den Menüpunkt Sonde IR die Option Extern auswählen (10.1.13 Kamera-Parameter, Seite 38).

In der digitale I/O-Karte die Werte auf folgende Weise einstellen: (10.1.11 Digitale I/O, Seite 37):

- **ID Alarm:** 1
- **Art:** NORMALERWEISE GEÖFFNET
- **Aktion:** IR_FILTER

8.10.3 Die Einheit mit den LED-Scheinwerfern synchronisieren

Die Einheit wird wie folgt mit den LED-Scheinwerfern synchronisiert:

- Den linken Scheinwerfer einstellen. (MASTER):
 - **Einschaltschwelle:** Wert entsprechend dem Bedarf einstellen (8.10.5 Einstellung der Einschaltsschwelle der LED-Scheinwerfer., Seite 28).
 - **Infrarotleistung:** Wert entsprechend dem Bedarf einstellen (8.10.6 Einstellung der Leistung der LED-Scheinwerfer., Seite 28).

- Regelung des rechten Scheinwerfers (SLAVE):
 - **Einschaltschwelle:** Wert auf Maximum einstellen (8.10.5 Einstellung der Einschaltsschwelle der LED-Scheinwerfer., Seite 28).
 - **Infrarotleistung:** Wert auf Minimum einstellen (8.10.6 Einstellung der Leistung der LED-Scheinwerfer., Seite 28).

Über den Menüpunkt Parameter Kamera die Option Intern auswählen (10.1.13 Kamera-Parameter, Seite 38).

8.10.4 Manuelle Aktivierung der LED-Scheinwerfer

Für die Aktivierung des LED-Scheinwerfers ist Folgendes notwendig:

- Den linken Scheinwerfer einstellen. (MASTER):
 - **Einschaltschwelle:** Den Wert auf OFF stellen. (8.10.5 Einstellung der Einschaltsschwelle der LED-Scheinwerfer., Seite 28).
 - **Infrarotleistung:** Wert entsprechend dem Bedarf einstellen (8.10.6 Einstellung der Leistung der LED-Scheinwerfer., Seite 28).
- Regelung des rechten Scheinwerfers (SLAVE):
 - **Einschaltschwelle:** Wert auf Maximum einstellen (8.10.5 Einstellung der Einschaltsschwelle der LED-Scheinwerfer., Seite 28).
 - **Infrarotleistung:** Wert auf Minimum einstellen (8.10.6 Einstellung der Leistung der LED-Scheinwerfer., Seite 28).

8.10.5 Einstellung der Einschaltsschwelle der LED-Scheinwerfer.

! Der rechte Scheinwerfer muss immer auf die maximale Helligkeit eingestellt sein.



Abb. 39

Der Scheinwerfer besitzt einen integrierten Dämmerungssensor, der eine automatische Ein- und Ausschaltung unter vorher festgelegten Lichtverhältnissen ermöglicht.

Der Dämmerungssensor wird werkseitig auf eine festgelegte Lichtstärke eingestellt, welche für den Großteil der Installationen geeignet ist (etwa 50lx). Zum Ändern der Einsatzgrenze den an der Rückseite des Scheinwerfers angebrachte Deckel entfernen und die Einstellung vornehmen mittels Schraubenzieher.

Durch Drehen des Trimmers im Uhrzeigersinn im Nachtmodus, wird die Umschaltung vorgezogen (auf einen höheren Helligkeitswert). Durch Drehen des Trimmers gegen den Uhrzeigersinn wird die Umschaltung im Nachtmodus verzögert (auf einen niedrigeren Helligkeitswert).

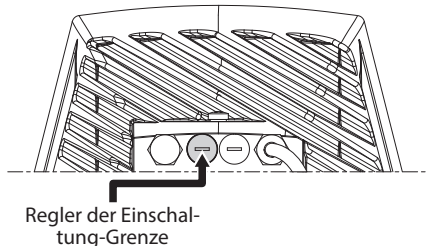

Abb. 40

Die geeigneten Lichtverhältnisse für das Einschalten des Scheinwerfers abwarten. Den Trimmer langsam drehen, bis sich die LED an der Trimmerseite einschaltet. Nachdem die Eingriffsschwelle überschritten wurde (LED eingeschaltet), etwas in die entgegengesetzte Richtung drehen.

! Nach den Einstellungen prüfen, dass der Verschlussdeckel angemessen angezogen ist, um die hermetische Dichtheit des Produkts zu garantieren.

8.10.6 Einstellung der Leistung der LED-Scheinwerfer.

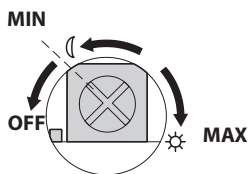
! Der rechte Scheinwerfer muss immer auf die minimale Leistung eingestellt sein.

i Der Scheinwerfer wird im Werk zur Erbringung maximaler Leistung eingestellt. Falls es nicht nötig sein sollte, entfernte Objekte zu beleuchten oder wenn das Bild wegen zu hoher Lichtintensität zu stark angestrahlt ist, die Leistung regulieren, sie zu verringern und Energie zu sparen.



Abb. 41

Die hermetische Verschlusskappe abdrehen. Den Trimmer in Uhrzeigersinn drehen, um die Leistung der Infrarot-Scheinwerfer zu erhöhen in in Gegenuhreigersinn, um die Leistung zu senken.

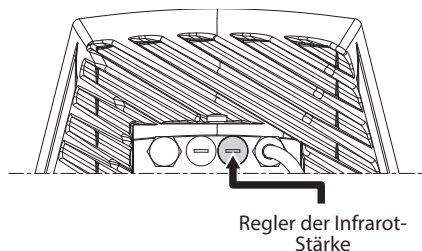

Abb. 42

! Nach den Einstellungen prüfen, dass der Verschlussdeckel angemessen angezogen ist, um die hermetische Dichtheit des Produkts zu garantieren.

8.11 Hardware Konfiguration

i Die Hardware-Konfiguration ist nur erforderlich, wenn der Kommunikationsmodus über serielle Telemetrie aktiviert werden soll. (12.1 Den Datenübertragungsmodus bearbeiten (von ONVIF-Protokoll auf serielle Telemetrie, Seite 42).

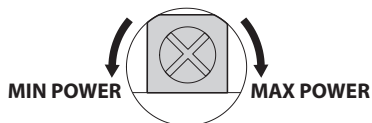
8.11.1 Öffnen der Konfigurationsklappe

Bevor die Einrichtung mit Strom versorgt wird, muss sie richtig mit den Dipschaltern innerhalb des Konfigurierungsklappchens konfiguriert werden. Das Konfigurierungsklappchen wird durch Entfernen der Schrauben geöffnet, wie in der Abbildung gezeigt.



Abb. 43

Für die DIP-schalter siehe Abbildung.

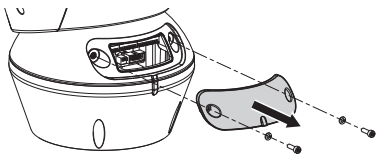

Abb. 44

i Nach Beendigung der Installation und der Verkabelung das Produkt wieder schließen.

8.11.2 Konfiguration der DIP1

i Der nach oben zeigende Kipphebel des Schalters steht für den Wert 1 (ON). Der nach unten zeigende Kipphebel des Dipschalters steht für den Wert 0 (OFF).

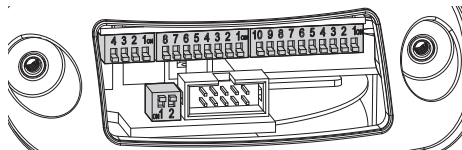
Switch 1 wird für die Aktualisierung der Firmware benutzt.



Abb. 45

KONFIGURATION DER DIP1					
Beschreibung	SW 4	SW 3	SW 2	SW 1	Baud rate
Einstellung Baudrate	OFF	OFF	OFF	–	300 baud
	ON	OFF	OFF	–	600 baud
	OFF	ON	OFF	–	1200 baud
	ON	ON	OFF	–	2400 baud
	OFF	OFF	ON	–	4800 baud
	ON	OFF	ON	–	9600 baud
	OFF	ON	ON	–	19200 baud
	ON	ON	ON	–	38400 baud
Firmware-Aktualisierung	–	–	–	ON	Programmierung befähigt
	–	–	–	OFF	Programmierung gesperrt

Tab. 9

8.11.3 Konfiguration von DIP2

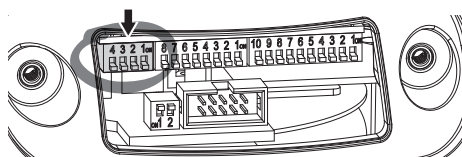
i Der nach oben zeigende Kipphebel des Schalters steht für den Wert 1 (ON). Der nach unten zeigende Kipphebel des Dipschalters steht für den Wert 0 (OFF).

Der Schwenk-Neige-Kopf kann mit den verschiedenen Protokollen gesteuert werden.



Abb. 46

KONFIGURATION VON DIP2								
Protokoll	SW 8	SW 7	SW 6	SW 5	SW 4	SW 3	SW 2	SW 1
PTZ Manager ¹	OFF	OFF	OFF	OFF	OFF	OFF	OFF	OFF
MACRO (VIDEOTEC)	OFF	OFF	OFF	OFF	OFF	ON	ON	ON
PANASONIC	OFF	OFF	OFF	ON	OFF	ON	OFF	OFF
PELCO D	OFF	OFF	OFF	OFF	ON	OFF	OFF	ON
AMERICAN DYNAMICS	OFF	OFF	OFF	OFF	ON	ON	ON	OFF
VISTA	OFF	OFF	OFF	ON	OFF	OFF	ON	ON

Tab. 10 ¹ Konfiguration: MACRO (VIDEOTEC), 115200 baud, RS-232, Adresse 1. Diese Option benötigt keine Einstellung der DIP-switch (DIP1, DIP3).

Tab. 11

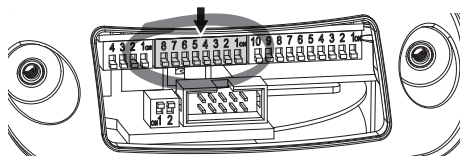
8.11.4 Konfiguration von DIP3

i Der nach oben zeigende Kipphebel des Schalters steht für den Wert 1 (ON). Der nach unten zeigende Kipphebel des Dipschalters steht für den Wert 0 (OFF).



Abb. 47

8.11.4.1 Adressekonfiguration

Die Schalter von 1 bis 8 können für die Konfiguration der Adresse der Einheit verwendet werden (von 1 bis 255).

Die Vorgabe der Adresse erfolgt nach dem Binärcode (A Anhang - Adressentabelle, Seite 50).

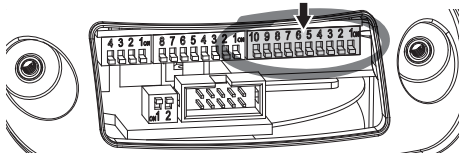
8.11.4.2 Die Leitungen der seriellen Datenübertragung konfigurieren

Das Produkt sieht eine serielle Leitung für die Datenübertragung RS-485 und eine serielle Leitung RS-232 vor.

Die Schalter 10 und 9 können für die Konfiguration der Leitungen für die serielle Datenübertragung verwendet werden.

KONFIGURATION VON DIP3

Beschreibung	SW 10	SW 9
Ein-Wege-Kommunikation an der Leitung RS-485-1. Zwei-Wege-Kommunikation an der Leitung RS-232.	OFF	OFF
Zwei-Wege-Kommunikation, half-duplex, an der Leitung RS-485-1.	ON	ON

Tab. 12

8.11.5 Konfiguration von DIP4

i Die Einstellung dieses Dipschalters erfolgt in umgekehrter Reihenfolge wie die vorherige. Der nach oben zeigende Kipphebel des Schalters steht für den Wert 0 (OFF). Der nach unten zeigende Kipphebel des Dipschalters steht für den Wert 1 (ON).

Auf der Platine befinden sich zwei Switches für die Konfiguration der Terminierung (120 Ohm) der seriellen Linien.



Abb. 48

Jede Einheit, die am Leitungsende hängt, muss mit dem zugehörigen Switch mit einem Abschlusswiderstand beschaltet werden, um zu vermeiden, dass entlang der Leitung Reflexionen und Deformationen auftreten.

KONFIGURATION VON DIP4

Serielle Linie	SW 2	SW 1	Beschreibung
Factory default	–	ON	Eingeschaltet
	–	OFF	Deaktiviert
Linie RS-485-1	ON	–	Beendet
	OFF	–	Nicht beendet

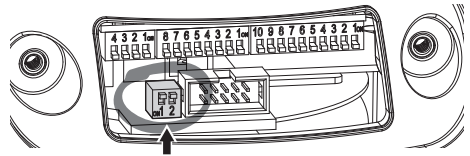
Tab. 13

Um den Schwenk-Neige-Kopf auf die Werkseinstellungen rückzustellen siehe entsprechendes Kapitel. (10.1.15 Factory Default, Seite 39).

9 Einschaltung



Sicherstellen, dass die Einheit und die anderen Bauteile der Anlage korrekt geschlossen sind, um den Kontakt mit unter Spannung stehenden Bauteilen zu verhindern.



Im normalen Betrieb kann der Scheinwerfer an der Oberfläche Hohe Temperaturen erreichen. Vermeiden Sie die direkte Berührung und positionieren Sie das Gerät an einem Ort, der für Unbefugte unzugänglich ist. Bevor man sie berührt, muss deshalb die Ausleuchtungseinrichtung abgeschaltet werden und mindestens 10 Minuten lang abkühlen.



Nicht die Nähe der Einrichtung aufsuchen, wenn sie mit Strom gespeist ist. Nur bei abgeschalteter Stromversorgung auf die Vorrichtung einwirken.



Vergewissern Sie sich, dass alle Teile solide und zuverlässig befestigt sind.



Der automatische Vorheizvorgang (De-Ice) könnte immer dann aktiviert werden, wenn das Gerät bei einer Umgebungstemperatur von unter 0°C in Betrieb genommen wird. Dieser Vorgang dient dazu, auch bei niedrigen Temperaturen den einwandfreien Betrieb der Einrichtungen sicherzustellen. Die Dauer liegt je nach Bedingungen zwischen 60 und 105 Minuten.

Für das Einschalten der Einheit die elektrische Versorgung anzulegen.

Die elektrische Versorgung abtrennen, um die Einheit abzuschalten.

10 Konfiguration

10.1 Web-Schnittstelle

i Beim ersten Anschluss eine Adresse zuweisen, die nicht 192.168.0.100 ist.

i Unterstützte Browser: Microsoft Internet Explorer, Google Chrome, Mozilla Firefox.

i Die MAC Address wird auf dem Etikett an der CPU-Karte angegeben.



Abb. 49

Der erste Schritt zur Konfiguration des S-N-Kopfes ist die Verbindung mit seiner Web-Schnittstelle.

In den Voreinstellungen ist der S-N-Kopf so konfiguriert, dass automatisch eine Adresse mit dem DHCP-Protokoll festgelegt wird und das Gerät mithilfe des Protokolls ONVIF, S-Profil, erkannt werden kann.

Sollte kein DHCP Server verfügbar sein, wird der S-N-Kopf automatisch mit der Adresse 192.168.0.100 sich konfigurieren.

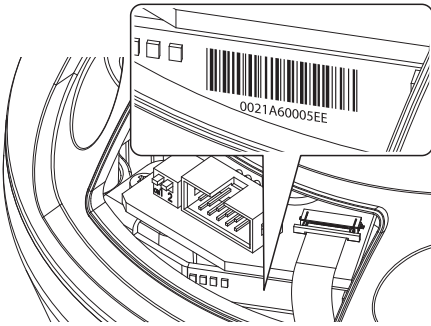
Sollte kein VMS mit diesen Auto Discovery Funktionen durch ONVIF verfügbar sein, kann die erworbene Adresse in den Logs des DHCP-Servers gelesen werden.

Die Web-Schnittstelle des S-N-Kopfes kann man zugreifen, indem man mit einem Browser die Adresse http://IP_Adresse aufruft und sich mit folgenden voreingestellten Zugangsdaten einloggt:

- **Username:** admin
- **Kennwort:** admin

10.1.1 Erster Zugriff

Für einen korrekten Betrieb muss der Schwenk-Neige-Kopf gemäß der installierten Videokamera konfiguriert werden.

Erforderliche Parameter:

- Für den Datenaustausch mit der Kamera verwendetes IP-Protokoll.
- Typ der installierten Linsen (Motorzoom, fest oder integriert).
- Für die Verbindung mit der IP-Kamera erforderliche Zugangsdaten (Benutzername und Passwort der installierten Videokamera).



Abb. 50

! Die im Schwenk-Neige-Kopf installierte Kamera muss so konfiguriert sein, dass sie ihre IP-Adresse über DHCP erhält.

10.1.2 Home

Wenn die Anmeldung erfolgreich war, öffnet sich die Schnittstelle zur Steuerung des Schwenk-Neige-Kopfes.

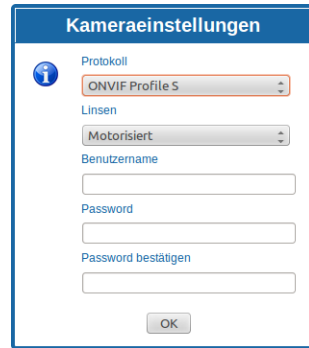

Abb. 51

10.1.3 Benutzersteuerung

Um den Schwenk-Neige-Kopf via Browser zu steuern, wählen Sie den Eintrag Benutzersteuerung. Es öffnet sich ein neues Fenster mit einer virtuellen Tastatur zum Absenden von Befehlen.



Abb. 52

Auf der virtuellen Tastatur befinden sich die folgenden Steuerungen:

- **Wahlschalter Geschwindigkeit:** Ermöglicht die Auswahl der Geschwindigkeit der Bewegungen des Schenk-Neigekopfes.

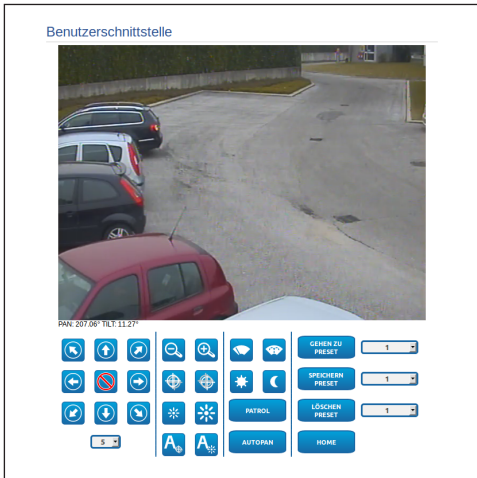

Abb. 53

- **Zoom wide/Zoom tele**



Abb. 54

- **Focus far/Focus near/Auto focus**



Abb. 55

- **Iris close/Iris open/Auto iris**



Abb. 56

- **Wiper/Washer**



Abb. 57

- **Day:** Aktivierung Filter IR der Kamera. Falls vorhanden, werden die LED- Scheinwerfer ausgeschaltet.



Abb. 58

- **Night:** Deaktivierung des Filters IR der Kamera. Falls vorhanden, werden die LED-Scheinwerfer eingeschaltet.



Abb. 59

10.1.4 Geräteparameter

Im Menü-Eintrag Geräteparameter können der Name des Schwenk-Neige-Kopfes eingestellt und andere Zusatzinformationen angezeigt werden.

Geräteparameter	
GeräteName	UlisseNet.cam
Produktcode	UPT2SVJAN00E
Seriennummer	113121290001
MAC-Adresse	00:21:A6:00:07:D8
Produkt-ID	2
Firmware-Version CPU Board	2.0
Firmware-Version NET Board	6.0.0
Firmware-Version MPP Board	6.0.0
Hardware-Revision	0
MajorRevision	0
MinorRevision	0
Getüschsort	0

Abb. 60

10.1.5 Gerätestatistiken

Im Menü-Eintrag Gerätestatistiken können alle während des Betriebs des Schwenk-Neige-Kopfes gesammelten Statistiken eingesehen aber nicht geändert werden.

Statistiche Dispositivo	
Grati Pan	3364
Grati TR	1442
Accessioni	133
Ore di lavoro	26
Temperatura massima custodia (°C)	40
Temperatura minima custodia (°C)	65454
Temperatura massima scheda PAN (°C)	50
Temperatura minima scheda PAN (°C)	22
Temperatura massima scheda CPU (°C)	43
Temperatura minima scheda CPU (°C)	20
Temperatura massima scheda NET (°C)	39
Temperatura minima scheda NET (°C)	19
Periodo accensione fan IR	0

Abb. 61

10.1.6 Netzwerk-Konfiguration

Im Menü-Eintrag Netzwerk-Konfiguration kann die Netzwerk-Einstellung des Schwenk-Neige-Kopfes geändert werden. Es kann eingestellt werden, ob das Gerät eine statisch oder dynamisch mit DHCP zugewiesene oder eine selbstgenerierte Adresse haben muss. Das Gerät unterstützt das Internet Protocol (IP) in Version 4.

i Bei selbstgenerierter Adresse wird sich das Gerät eine Adresse im Range 169.254.0.0/16 selbst geben.

Auf derselben Seite können außerdem 2 DNS konfiguriert und eingestellt werden, welche Mechanismen aktiv sein müssen, um die Geräte im lokalen Netzwerk automatisch zu identifizieren.

Netzwerk-Konfiguration	
IP-Version	IPv4
Adressstyp	STATISCH
IP-Adresse (IPv4)	192.168.103.121
Subnet Mask (IPv4)	255.255.255.0
Gateway (IPv4)	192.168.103.1
Automatische DNS-Suche	DEAKTIVIERT
Primärer DNS-Server	8.8.4.4
Alternativer DNS-Server	8.8.8.8
Date & Time	2013-05-27 14:42:37 UTC
NTP-Server	DEAKTIVIERT
PC Sync	AKTIV
UPNP	AKTIV
Zeroconf	AKTIV
Multicast Discovery	AKTIV
WS Discovery	AKTIV

Abb. 62

Außerdem kann angegeben werden, ob das Gerät sich mit einem externen NTP (Network Time Protocol) Server synchronisieren muss.

- **NTP -> DEAKTIVIERT:** Stellen Sie diese Option ein, wenn Datum und Uhrzeit des Geräts nicht synchronisiert werden sollen.
- **NTP -> DHCP:** Stellen Sie diese Option ein, wenn Datum und Uhrzeit des Geräts mit einem durch den DHCP-Server angegebenen NTP-Server (Network Time Protocol) synchronisiert werden sollen.
- **NTP -> STATISCH:** Stellen Sie diese Option ein, wenn Datum und Uhrzeit des Geräts mit einem durch statische Adresse angegebenen NTP-Server synchronisiert werden sollen.

i Für einen korrekten Betrieb des Gerätes muss die Schwenkung mit der Software VMS mithilfe eines Servers NTP synchronisiert werden.

i Damit das Gerät einwandfrei funktioniert, muss die Kamera mit dem Schwenk-Neige-Kopf synchronisiert werden. Um diese Synchronisierung zu erreichen, wählen Sie auf der Web-Seite der Kamera die Option NTP from DHCP oder geben Sie die Adresse 192.0.0.1 als statische Adresse des NTP-Servers an.

10.1.7 Benutzer-Konfiguration

Im Menü-Eintrag Benutzer-Konfiguration können die Benutzer verwaltet werden, die Zugriff auf den Schwenk-Neige-Kopf haben. Die Benutzer Typ Administrator können auf die Produktkonfiguration zugreifen. Die Benutzer Typ Operator, User und Anonymous haben begrenzten Zugriff auf die Verwaltungsseiten.



Abb. 63

i Das Gerät kann nur von Anwendern mit Administratorrechten konfiguriert werden.

10.1.8 Bewegungsparameter

Im Menü-Eintrag Bewegungsparameter können via Internet alle Parameter des Schwenk-Neige-Kopfes kontrolliert werden.

- **Offset Pan:** Der Schwenk-Neige-Kopf hat eine Position von 0°, die mechanisch definiert ist. Die Funktion Offset Pan ermöglicht es, auf Softwareebene eine andere Position als 0° festzulegen.
- **Höchstgeschwindigkeit:** Hier kann die Höchstgeschwindigkeit bei manueller Steuerung vorgegeben werden..
- **Geschwindigkeit Mit Zoom:** Zum Einschalten der Geschwindigkeit mit Zoom. Bei Aktivierung dieses Parameters wird die Geschwindigkeit für Pan und Tilt automatisch in Abhängigkeit vom Zoomfaktor reduziert.
- **Tilt-Faktor:** Reduzierfaktor für die manuelle Geschwindigkeit der Tiltachse.
- **Grenzkpunkte Pan:** Aktiviert die Grenzkpunkte für die Funktion Pan (Kameraschwenk).
- **Beginn Pan:** Vorgabe der Grenzposition zu Beginn des Kameraschwenks (Pan).
- **Ende Pan:** Vorgabe der Grenzposition am Ende des Kameraschwenks (Pan).
- **Beginn Tilt:** Vorgabe der Grenzposition zu Beginn der Kameraneigung (Tilt)
- **Ende Tilt:** Vorgabe der Grenzposition am Ende der Kameraneigung (Tilt).



Abb. 64

10.1.8.1 Autopan

Im Unterabschnitt Autopan können die Presets für Beginn und Ende des Autopan angegeben werden.

Abb. 65

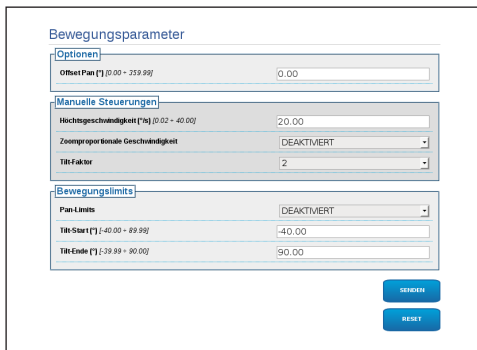
10.1.8.2 Patrol

Im Unterabschnitt Patrol können die Presets für Beginn und Ende des Patrol angegeben werden. Außerdem kann angegeben werden, ob die Abtastung der Presets in kausaler Weise oder nicht erfolgen soll.

Abb. 66

10.1.8.3 Bewegungsanforderung

Im Unterabschnitt Aufruf Bewegungen kann eine Inaktivitätsdauer angegeben werden, nach der der Schwenk-Neige-Kopf eine der folgenden Funktionen ausführt: Rückkehr in die Home-Position, Start des Autopan oder Start des Patrol.

Abb. 67

10.1.9 Preset-Parameter

Im Menü-Eintrag Preset-Parameter sind einige Parameter der Presets konfigurierbar:

- **Scan Geschwindigkeit:** Geschwindigkeit in Grad pro Sekunde, mit der ein Preset auf ausdrückliche Aufforderung des Bedieners erreicht wird.
- **Rampentyp:** Erlaubt die Wahl der Beschleunigungen des Schwenk-Neige-Kopfes.
- **Bewegungsgeschwindigkeit (Default):** Die bei den Funktionen Autopan und Patrol benutzten Geschwindigkeiten.
- **Default-Geschwindigkeit vorgeben:** Die Default-Geschwindigkeit wird auch als Abtastgeschwindigkeit für alle Presets eingestellt.
- **Standardpause:** Default-Verweilzeit in jedem Preset in Sekunden.
- **Default-Pause vorgeben:** Die Default-Pause wird für alle Presets eingestellt.

Abb. 68

10.1.10 Preset-Parameter (Erweitert)

Im Abschnitt Preset-Parameter (Erweitert) können die Werte für Geschwindigkeit und Pause für jeden Preset individuell angepasst, sowie die Presets selbst aktiviert/deaktiviert werden.

Abb. 69

10.1.11 Digitale I/O

In der Registerkarte Digitale I/O können die digitalen Kanäle des Schwenk-Neige-Kopfes konfiguriert werden. Es folgt eine kurze Beschreibung der konfigurierbaren Parameter für jeden Digitaleingang.

- **ID Alarm:** Verwendetes Feld für die Auswahl des gewünschten Digitaleingangs
- **Art:** Zeigt den Standard-Status des Digitaleingangs an. Kann auf normalerweise geöffnet oder normalerweise geschlossen eingestellt werden.
- **Aktion:** Jedem Eingang kann eine Aufnahme zugeordnet werden. Die Aufnahme wird in dem Moment aktiviert, in dem der Kontakt in einen anderen als den Standard-Status übergeht. Es folgt eine Liste der verfügbaren Aufnahmen:
 - **NONE:** Keine Aufnahme.
 - **SCAN:** Positionierung des Schwenk-Neige-Kopfes am ausgewählten Preset.
 - **PATROL:** Aktivierung PATROL.
 - **AUTOPAN:** Aktivierung AUTOPAN.
 - **WIPER:** Aktivierung Wiper.
 - **WASHER:** Aktivierung Waschsequenz Glas
 - **RELAIS 1:** Aktivierung Relais 1.
 - **RELAIS 2:** Aktivierung Relais 2.
 - **IR FILT:** Deaktivierung des Filters IR der Kamera. Falls vorhanden, werden die LED-Scheinwerfer eingeschaltet.

Zur Kontrolle des einwandfreien Betriebs der Alarme erscheint auf der Web-Seite ein Punkt, der im Normalzustand grün ist, und rot, wenn ein Alarm erkannt wird. Zur Kontrolle des einwandfreien Betriebs der Alarme erscheint auf der Web-Seite ein Punkt, der im Normalzustand grün ist, und rot, wenn ein Alarm erkannt wird.

Digitale I/O

Alarm-ID: 1

Typ: NORMALERWEISE GEÖFFNET

Aktion: NONE

SENDEN

RÜCKSETZ

Abb. 70

10.1.12 Washer

Die Pumpe für die Waschanlage des Schwenk-Neige-Kopfes wird in der Registerkarte Washer konfiguriert, in der mit dem Waschvorgang ein Preset verknüpft, die Dauer des Scheibenwaschvorgangs eingestellt und die Verzögerung für die Aktivierung und Deaktivierung des Scheibenwischers angegeben werden können.

Washer

Preset-Dauer (f = 2500): 1

Verzögerung Scheibenwischer Aktivierung (f = 240): 5

Waschdauer (f = 240): 5

Verzögerung Scheibenwischer Deaktivierung (f = 240): 5

SENDEN

RÜCKSETZ

Abb. 71

10.1.13 Kamera-Parameter

Die Parameter der IP-Kamera, die beim ersten Start eingestellt wurden, können im Abschnitt Kamera-Parameter geändert werden. Im Abschnitt Kamera-Parameter können außerdem der Zoomfaktor und die Genauigkeit der Zoom-Position angegeben werden. In diesem Abschnitt können auch die Daten der unterschiedlichen von der Kamera exportierten Profile ONVIF visualisiert werden.

Im Menüpunkt Linsen kann eine der folgenden Optionen ausgewählt werden:

- **Motorisiert:** S-N-Kopf gesteuert.
- **Integriert:** Kamera gesteuert.
- **Fest:** Nicht kontrollierbar.

Im Falle von motorisierten Linsen besteht die Möglichkeit den Anschluss (gemeinsamer Leiter oder umgekehrte Polarität) und die Rotation der Polarität von Zoom, Focus und Iris einzuschalten.

Abb. 72

Um die Einstellungen der Videokamera zu verändern, die Taste VTTunnel drücken. (10.1.14 Werkzeuge, Seite 38).

10.1.14 Werkzeuge

Im Menü-Eintrag Werkzeuge können die gesamte Konfiguration des Schwenk-Neige-Kopfes oder nur bestimmte Abschnitte auf die vordefinierten Werte zurückgesetzt werden.

Außerdem kann in diesem Abschnitt:

- Die Firmware der Vorrichtung aktualisieren.
- Den Schwenk-Neige-Kopf wieder starten.
- Die Anwendung VTTunnel herunterladen, um die Verbindung mit der IP-Kamera zu aktivieren, unbedingt nötig, um auf ihre Web-Seite zuzugreifen.

Abb. 73

10.1.15 Factory Default

! Falls das Kennwort nicht mehr verfügbar ist, können mit einer Reset Taste, die sich in der Basis befindet, die Werkseinstellungen wiederhergestellt werden.

Für den Reset der werkseitigen Einstellungen bezüglich Netz, Benutzerzugriff und Konfiguration der Kamera folgende Prozedur ausführen:

- Die Einheit mit Strom versorgen.
- Die Tür der Dipschalter öffnen.
- Lokalisierung des DIP-Schalters 4 (01). Den Schalter 1 wieder nach unten stellen, Wert 1 (ON).
- Das vorläufige Ausschalten der LED abwarten (02).
- Den Schalter 1 wieder nach oben stellen, Wert 0 (OFF).
- Die Klappe schließen.



Abb. 74

10.2 VTTunnel

i Die Anwendung funktioniert nur mit Java™. Wenn Java™ nicht zuvor installiert wurde, die letzte Version von der Website www.java.com herunterladen.

i Die Anwendung kann nur mit der ersten aktiven Netzwerk-Schnittstelle in Verbindung treten. Am Schwenk-Neige-Kopf nur das Netzkabel angeschlossen lassen.

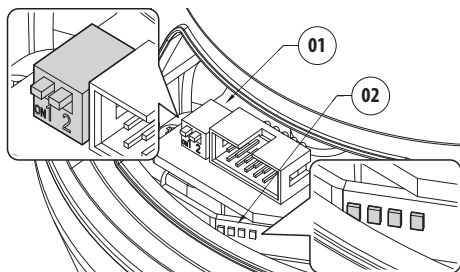
i Die Ausführung der Anwendung erfordert die Administratorrechte des Computers. Auf dem Monitor könnte die Meldung "You have to execute javaw as administrator" angezeigt werden. In diesem Fall müssen die Ausführungseigenschaften der Datei `javaw.exe` im Java-Installationsordner verändert werden.

Um die IP-Kamera anzuschließen, müssen Sie das VTTunnel- Programm verwenden, aus dem Menü Werkzeuge bootfähig.

Beim Start des Programmes wird eine Liste von vernetzten Geräten angezeigt. Für den Anschluss an die Kamera muss der gewünschte Schwenk-Neige-Kopf ausgewählt werden und die Taste Connect gedrückt werden.

Sobald die Verbindung hergestellt ist, kann die Webseite der IP-Kamera an 192.0.0.64 erreicht werden.

Wenn die Operationen an der Kamera zu Ende sind, kann man die Verbindung durch Klicken auf die Disconnect- Taste schließen. Es ist möglich, je eine Kamera zu verbinden, so müssen Sie aus dem S-N-Kopf trennen, bevor man auf einer anderen Positioniereinheit arbeiten kann.



Abb. 75

i Falls bei der Konfiguration der Videokamera die Videostreaming-Parameter geändert werden, ist es erforderlich die Schwenkung wieder zu aktivieren.

11 Zubehör

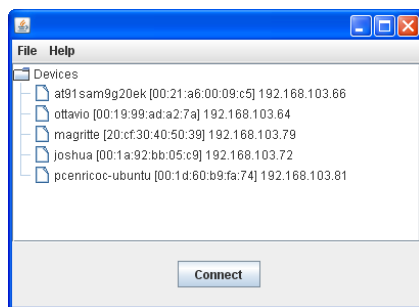

Für weitere Details zur Konfiguration und zum Gebrauch beachten Sie bitte das Handbuch des entsprechenden Geräts.

11.1 Waschanlage

Der Schwenk-Neige-Kopf muss mit einer externen Pumpe ausgestattet sein, die Wasser für die Reinigung des Glases liefert.

Wird der Befehl abgesendet, positioniert sich der Schwenk-Neige-Kopf mit dem Fenster vor der Düse. (10.1.3 Benutzersteuerung, Seite 33). Es werden nun für eine bestimmte Zeit die Pumpe und der Scheibenwischer aktiviert. Am Ende des Vorgangs kehrt der S-N-Kopf in die Ausgangsposition zurück.



Abb. 76

11.1.1 Anschluss der Waschanlage.



ACHTUNG! Die Anlage gehört zum Typ TNV-1. Nicht an Kreisläufe SELV anschließen.

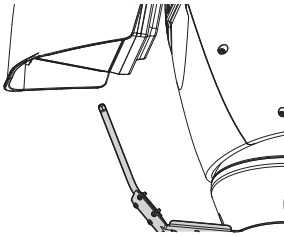

ACHTUNG! Zur Senkung der Brandgefahr dürfen nur UL Listed oder CSA zertifizierte Kabel benutzt werden, die mindestens der Größe 0.13mm^2 (26 AWG) entsprechen.



Alle Signalkabel mit einem Kabelbinder müssen zusammengefasst werden.

ANSCHLUSS DER WASCHANLAGE.	
Klemmen	Beschreibung
O1-C1	Potentialfreier Kontakt für die Aktivierung der Waschanlage.

Tab. 14



Abb. 77

11.2 Wandhalterung

Wandhalterung mit interner Kabelführung.

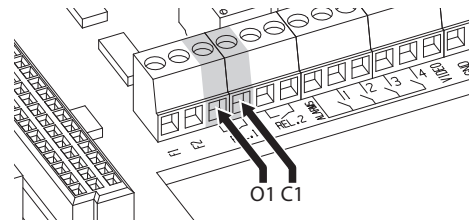

Abb. 78

11.3 Halterung für Brüstungsmontage

Brüstungshalterung mit interner Kabelführung.

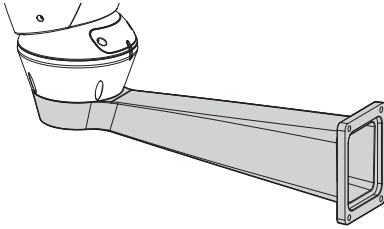

Abb. 79

11.4 Netzteil mit Steuerung der Scheinwerfer

Dichtes Gehäuse mit Netzteil und Kontrolle der Scheinwerfer.

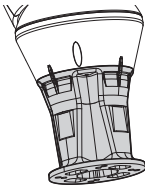

Abb. 80 Standardversion des Gehäuses.



Abb. 81 UL-zertifizierte Version des Gehäuses.

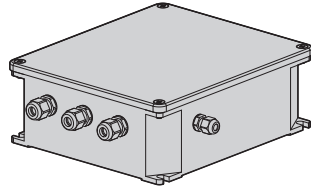

Für weitere Infos bitte entsprechendes Kapitel beachten (8.4.3 Anschluss der Alarmeingänge, der Dämmerungsschalter und der Relais, Seite 22).

12 Anleitung für den Sonderbetrieb

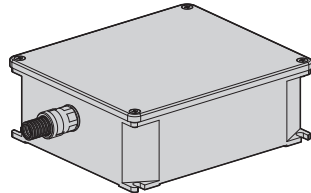
12.1 Den Datenübertragungsmodus bearbeiten (von ONVIF-Protokoll auf serielle Telemetrie)

Der Schwenk-Neige-Kopf ist ursprünglich für die Datenübertragung über ONVIF-Protokoll konfiguriert.

12.1.1 Verfahren zur Bearbeitung des Datenübertragungsmodus

Den Schwenk-Neige-Kopf ausschalten.

Die Dipschalter einstellen (8.11 Hardware Konfiguration, Seite 29). Das im Folgenden angegebene Verfahren befolgen:

Baud rate: 38400 (ON ON ON OFF)

Protokoll: MACRO (OFF OFF OFF OFF OFF ON ON ON)

Serielle Datenübertragung und

Telemetrieadresse: RS-485 Halb-Duplex, Adresse 1 (ON ON OFF OFF OFF OFF OFF ON)

Den Schwenk-Neige-Kopf einschalten.

Im Browser die Adresse <indirizzo_ip>/cgi-bin/pc.cgi eingeben.



Abb. 82

Den Produkt-Code ändern: der Buchstabe N wird durch Y ersetzt. Beispiel: Von UPT2SVUAN00E bis UPT2SVUAY00E.

Auf Eingabe klicken. Den Neustart des Produkts bestätigen.

Im Browser die Adresse <indirizzo_ip>/cgi-bin/pc.cgi eingeben, um zu prüfen, dass der Produkt-Code geändert wurde. Bei Problemen den Vorgang von Anfang an wiederholen.

Den Schwenk-Neige-Kopf ausschalten.

Die in der Abbildung gezeigten DIP-Schalter auf OFF stellen.



Abb. 83

Die serielle Datenübertragung des Schwenk-Neige-Kopfs konfigurieren, wie von der Videokamera gefordert. Die DIP-Schalter der seriellen Datenübertragungen betätigen. (8.11 Hardware Konfiguration, Seite 29).

Die serielle Schnittstelle der Videokamera an den Verbinder anschließen.

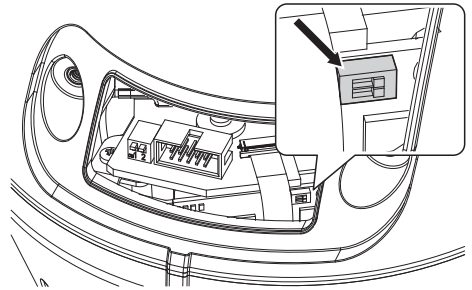

Abb. 84 Grau: RS-485 +. Rosa: RS-485 -.

Die Versorgung der Videokamera anschließen.

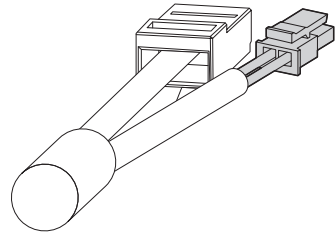

Abb. 85

Den Schwenk-Neige-Kopf einschalten.

Der Schwenk-Neige-Kopf ist nun für die Datenübertragung über serielle Telemetrie (RS-485) konfiguriert.

13 Wartung

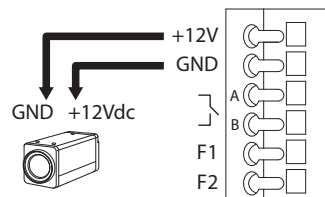

Die Wartung darf nur von Fachleuten vorgenommen werden, die befähigt sind, an elektrischen Schaltkreisen tätig zu werden.

13.1 Wechsel der Sicherungen



Wartung nur durchführen, wenn die Stromversorgung abgetrennt und die Trennvorrichtung offen ist.

Falls notwendig die abgebildete Sicherung austauschen (8.3 Beschreibung der Karte Anschlüsse, Seite 19).

WECHSEL DER SICHERUNGEN

Spannung	Schmelz- siche- rung F1	Schmelz- siche- rung F2
24Vac, 50/60Hz	F 6.3A L 250V 5x20	T 8A H 250V 5x20
120Vac, 50/60Hz	F 6.3A L 250V 5x20	T 4A H 250V 5x20
230Vac, 50/60Hz	F 6.3A L 250V 5x20	T 2A H 250V 5x20

Tab. 15

14 Reinigung

14.1 Reinigung des Glases und der Kunststoffteile



Zu vermeiden sind Äthylalkohol, Lösungsmittel, hydrierte Kohlenwasserstoffe, starke Säuren und Alkali. Diese Produkte können die behandelte Oberfläche beschädigen.

Es wird empfohlen, ein weiches Tuch und neutrale mit Wasser verdünnte Seife oder ein spezifisches Reinigungsmittel für Brillengläser zu verwenden.

14.2 Putzen des Germaniumfensters



Bei der Reinigung des Fensters ist darauf zu achten, dass die mit Carbon Coating behandelte Oberfläche nicht verkratzt oder gerillt wird. Wenn diese Beschichtung Schaden nimmt, besteht die Gefahr, dass die Durchlässigkeit der Oberfläche für Infrarotstrahlen beeinträchtigt wird.

Die Reinigung sollte mit einer milden Seife mit Wasser verdünnt erfolgen.

15 Müllentsorgungsstellen



Dieses Symbol und das entsprechende Recycling-System gelten nur für EULänder und finden in den anderen Ländern der Welt keine Anwendung.

Ihr Produkt wurde entworfen und hergestellt aus qualitativ hochwertigen Materialien und Komponenten, die recycelt und wiederverwendet werden können.

Dieses Symbol bedeutet, daß elektrische und elektronische Geräte am Ende ihrer Nutzungsdauer von Hausmüll getrennt entsorgt werden sollen.

Bitte entsorgen Sie dieses Gerät bei Ihrer örtlichen Sammelstelle oder im Recycling Centre.

In der Europäischen Union gibt es unterschiedliche Sammelsysteme für Elektrik- und Elektronikgeräte.

16 Problemlösung

Fordern Sie Fachleute für die Arbeiten an, wenn:

- Die Einheit nach einem Sturz beschädigt ist;
- Die Leistungen der Einheit merklich abgefallen sind.
- Die Einheit trotz der Befolgung sämtlicher Ausführungen in diesem Handbuch nicht korrekt funktioniert.

PROBLEM **Das Produkt lässt sich nicht einschalten.**

URSACHE *Falsche Verkabelung, Schmelzsicherungen durchgebrannt.*

LÖSUNG Anschlüsse prüfen. Die Kontinuität der Sicherungen überprüfen und im Falle eines Defektes müssen sie durch die aufgeführten Modelle ersetzt werden.

PROBLEM **Unter bestimmten Zoom-Bedingungen kommt es zur Interferenz des Gehäuses oder des Sonnenschutzdaches im aufgenommenen Bild (nur für Versionen mit motorisierter Optik).**

URSACHE *Position der Videokamera oder Optik im Verhältnis zum Fenster zu sehr zurückgesetzt.*

LÖSUNG Die Position der Videokamera und der Optik einstellen.

PROBLEM **Es kann keine Verbindung zur Kamera hergestellt werden.**

URSACHE *Fehlerhafter Anschluss der Kamera.*

LÖSUNG Prüfen Sie bitte die Kameraanschlüsse.

PROBLEM **Beim Einschalten bleibt die S-N-Kopf blockiert.**

URSACHE *Die Umgebungs-temperatur ist sehr niedrig.*

LÖSUNG Ende des Vorheizvorgangs abwarten.

PROBLEM **Es ist nicht möglich, den Schwenk-Neige-Kopf zu steuern.**

URSACHE *Fehlerhafte Konfiguration der Kommunikationsleitung.*

LÖSUNG Die Konfiguration der Dipschalter prüfen (8.11 Hardware Konfiguration, Seite 29).

17 Technische Daten

17.1 Allgemeines

Konstruktion aus Aluminiumdruckguss und Technopolymer

Pulverlackierung mit Epoxydpolyester, Farbe RAL9002

Top mount (OTT)

Zahnriemenantrieb

Slip-ring

Elektronische Endschalter

Vereinfachte Installation dank Steckverbinder und der leichten Austauschbarkeit an Ort und Stelle

Kein mechanisches Spiel

Encoders für absolute Positionierung

Vorinstallierter Wischer

Konfigurationsparameter des Telemetrie-Protokoll durch Dip-Schalter für RS485

17.2 Mechanik

Kabelverschraubungen: 3xM16

Horizontale Drehung: kontinuierlich

Neigung: +90° bis -40°

Schwenkgeschwindigkeit rechts - links (einstellbar): von 0.02°/s bis 100°/s (von 0.02°/s bis 40°/s, mit LED Scheinwerfern)

Neigegeschwindigkeit Auf-Ab einstellbar (einstellbar): von 0.02°/s bis 50°/s (von 0.02°/s bis 30°/s, mit LED Scheinwerfern)

Innere Nutabmessungen: Siehe Zeichnungen

Glasscheibe des Gehäuses (WxH): 124x112mm

Genauigkeit bei der Anfahrt von Vorwahlpositionen: 0.02°

Einheitsgewicht: 16.8kg (17.8kg, mit LED Scheinwerferbuegel)

17.3 Elektrik

Kompatibel mit Netzwerk-Kameras

Versorgungsspannung/Stromaufnahme:

- 230Vac, 0.4A, 50/60Hz
- 24Vac, 4A (8A mit LED Scheinwerfern), 50/60Hz
- 120Vac, 0.8A, 50/60Hz

Leistungsaufnahme:

- 100W
- 150-190W max mit LED Scheinwerfern in 24Vac
- 28.5W, S-N-Kopf unbewegt, ohne Heizung

Speisung Videokamera: 12Vdc (800mA)

4 Selbstgespeiste Alarめingänge

2 potentialfreie Kontakte: 30Vdc max o30Vac, @ 1A

17.4 Kommunikation

Ethernet-Verbindung: IEEE 802.3 100Base-Tx

17.5 Protokolle

ONVIF, S- Profil

17.6 Umgebung

Innen/Außen

Betriebstemperatur

- Mit Heizung: -20°C/+60°C
- Mit leistungsstärkerer Heizung: -30°C/+60°C

Impulsfestigkeit: bis zu 2kV zwischen zwei Leitungen, bis zu 4kV zwischen Leitung und Erde (Klasse 4)

17.7 Zertifizierungen

Elektrische Sicherheit (CE): EN60950-1, IEC60950-1

Elektromagnetische Verträglichkeit (CE): EN50130-4, EN61000-6-4, EN55022 (Klasse A), FCC Part 15 (Klasse A)

Außeninstallation (CE): EN60950-22, IEC60950-22

Fotobiologische Sicherheit (CE): EN62471 LED Scheinwerfer)

Schutzart IP: EN60529, IP66

Salznebelbeständig: EN50130-5, EN60068-2-52

UL- Zertifizierung: cULus Listed (TYPE 4X)

EAC-Zertifizierung

18 Technische Zeichnungen



Die Abmessungen der Zeichnungen sind in Millimeter angegeben.



Abb. 86 ULISSE PLUS NETCAM.



Abb. 87 ULISSE PLUS NETCAM, Version mit Vorrüstung für zwei LED-Scheinwerfer.

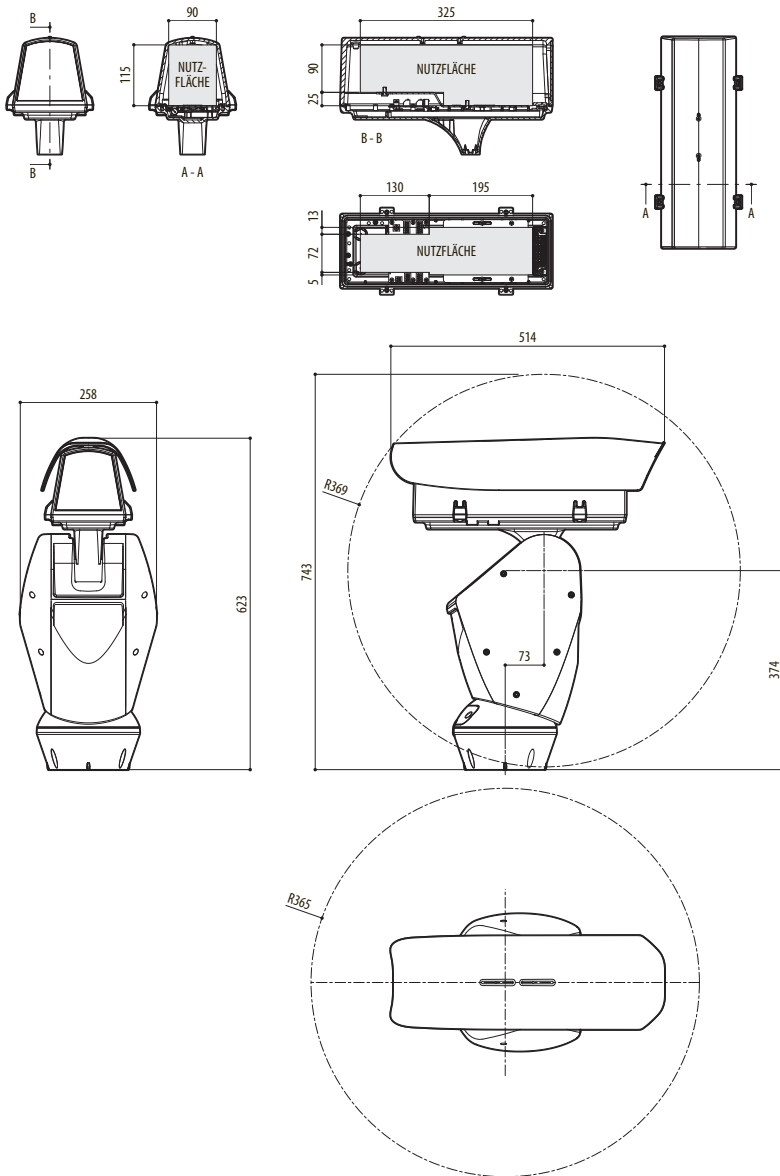

Abb. 88 ULISSE PLUS NETCAM, Version für Wärmebildkamera.

A Anhang - Adressentabelle

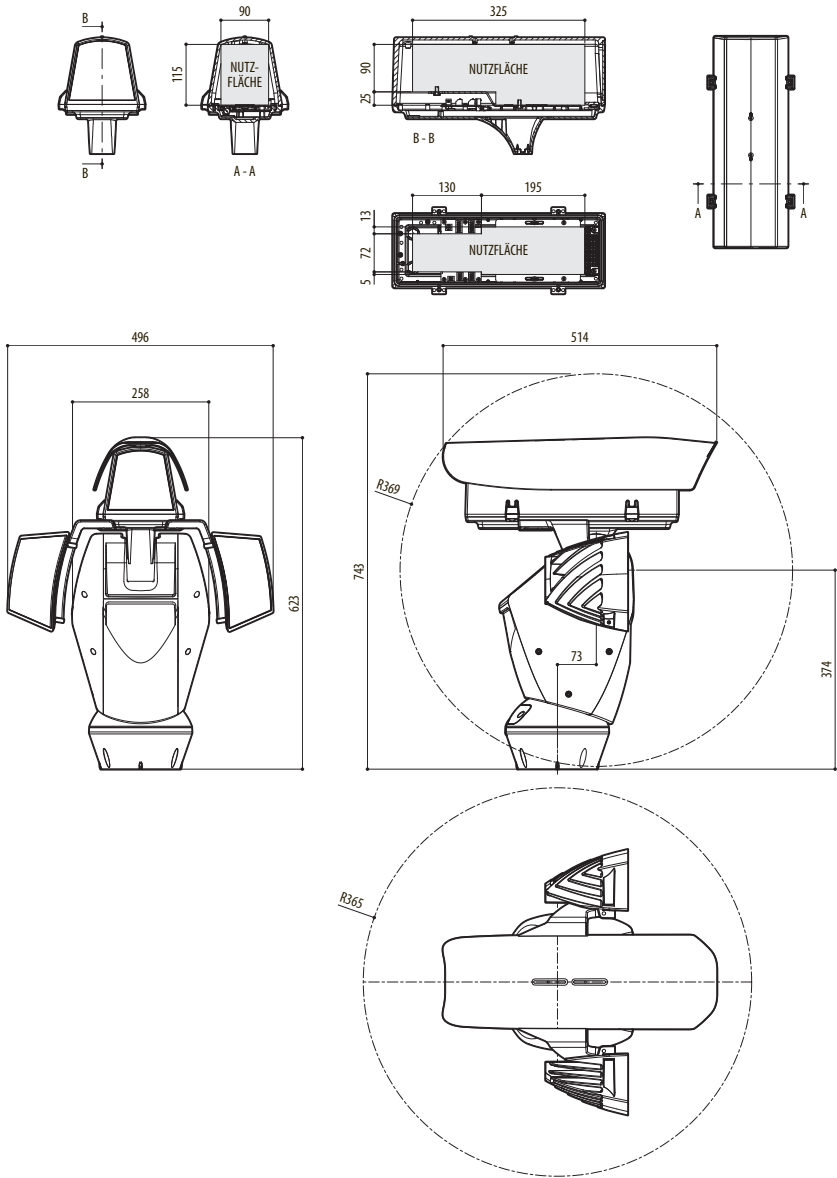

Der nach oben zeigende Kipphebel des Schalters steht für den Wert 1 (ON). Der nach unten zeigende Kipphebel des Dipschalters steht für den Wert 0 (OFF).

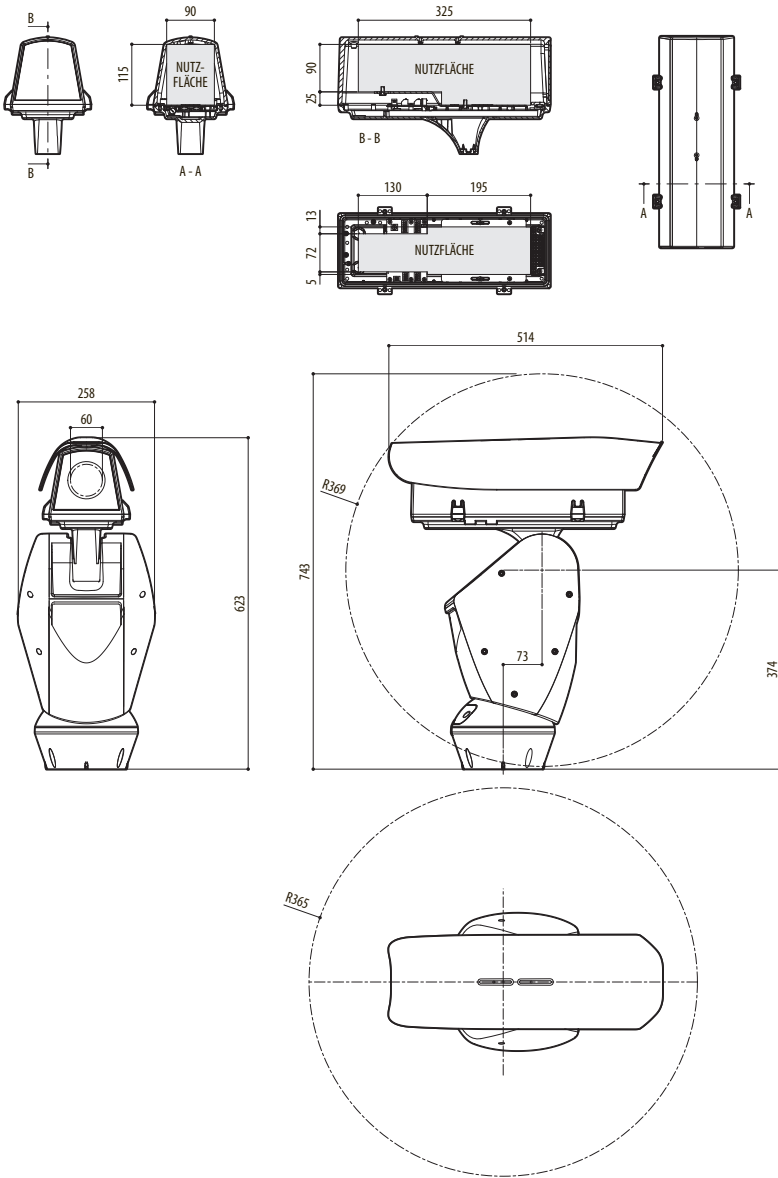
Nachstehend sind alle Kombinationsmöglichkeiten aufgelistet.

ADRESSEKONFIGURATION (DIP 3)								
SW 8	SW 7	SW 6	SW 5	SW 4	SW 3	SW 2	SW 1	Adresse
OFF	OFF	OFF	OFF	OFF	OFF	OFF	OFF	Adresse unfähige
OFF	OFF	OFF	OFF	OFF	OFF	OFF	ON	Adresse 1
OFF	OFF	OFF	OFF	OFF	OFF	ON	OFF	Adresse 2
OFF	OFF	OFF	OFF	OFF	OFF	ON	ON	Adresse 3
OFF	OFF	OFF	OFF	OFF	ON	OFF	OFF	Adresse 4
OFF	OFF	OFF	OFF	OFF	ON	OFF	ON	Adresse 5
OFF	OFF	OFF	OFF	OFF	ON	ON	OFF	Adresse 6
OFF	OFF	OFF	OFF	OFF	ON	ON	ON	Adresse 7
OFF	OFF	OFF	OFF	ON	OFF	OFF	OFF	Adresse 8
OFF	OFF	OFF	OFF	ON	OFF	OFF	ON	Adresse 9
OFF	OFF	OFF	OFF	ON	OFF	ON	OFF	Adresse 10
OFF	OFF	OFF	OFF	ON	ON	ON	ON	Adresse 11
OFF	OFF	OFF	OFF	ON	ON	OFF	OFF	Adresse 12
OFF	OFF	OFF	OFF	ON	ON	OFF	ON	Adresse 13
OFF	OFF	OFF	OFF	ON	ON	ON	OFF	Adresse 14
OFF	OFF	OFF	OFF	ON	ON	ON	ON	Adresse 15
OFF	OFF	OFF	ON	OFF	OFF	OFF	OFF	Adresse 16
OFF	OFF	OFF	ON	OFF	OFF	OFF	ON	Adresse 17
OFF	OFF	OFF	ON	OFF	OFF	ON	OFF	Adresse 18
OFF	OFF	OFF	ON	OFF	OFF	ON	ON	Adresse 19
OFF	OFF	OFF	ON	OFF	ON	OFF	OFF	Adresse 20
OFF	OFF	OFF	ON	OFF	ON	OFF	ON	Adresse 21
OFF	OFF	OFF	ON	OFF	ON	ON	OFF	Adresse 22
OFF	OFF	OFF	ON	OFF	ON	ON	ON	Adresse 23
OFF	OFF	OFF	ON	ON	OFF	OFF	OFF	Adresse 24
OFF	OFF	OFF	ON	ON	OFF	OFF	ON	Adresse 25
OFF	OFF	OFF	ON	ON	OFF	ON	OFF	Adresse 26
OFF	OFF	OFF	ON	ON	OFF	ON	ON	Adresse 27
OFF	OFF	OFF	ON	ON	ON	OFF	OFF	Adresse 28
OFF	OFF	OFF	ON	ON	ON	OFF	ON	Adresse 29
OFF	OFF	OFF	ON	ON	ON	ON	OFF	Adresse 30
OFF	OFF	OFF	ON	ON	ON	ON	ON	Adresse 31
OFF	OFF	ON	OFF	OFF	OFF	OFF	OFF	Adresse 32
OFF	OFF	ON	OFF	OFF	OFF	OFF	ON	Adresse 33
OFF	OFF	ON	OFF	OFF	OFF	ON	OFF	Adresse 34
OFF	OFF	ON	OFF	OFF	OFF	ON	ON	Adresse 35
OFF	OFF	ON	OFF	OFF	ON	OFF	OFF	Adresse 36
OFF	OFF	ON	OFF	OFF	ON	OFF	ON	Adresse 37
OFF	OFF	ON	OFF	OFF	ON	ON	OFF	Adresse 38

ADRESSEKONFIGURATION (DIP 3)

SW 8	SW 7	SW 6	SW 5	SW 4	SW 3	SW 2	SW 1	Adresse
OFF	OFF	ON	OFF	OFF	ON	ON	ON	Adresse 39
OFF	OFF	ON	OFF	ON	OFF	OFF	OFF	Adresse 40
OFF	OFF	ON	OFF	ON	OFF	OFF	ON	Adresse 41
OFF	OFF	ON	OFF	ON	OFF	ON	OFF	Adresse 42
OFF	OFF	ON	OFF	ON	OFF	ON	ON	Adresse 43
OFF	OFF	ON	OFF	ON	ON	OFF	OFF	Adresse 44
OFF	OFF	ON	OFF	ON	ON	OFF	ON	Adresse 45
OFF	OFF	ON	OFF	ON	ON	ON	OFF	Adresse 46
OFF	OFF	ON	OFF	ON	ON	ON	ON	Adresse 47
OFF	OFF	ON	ON	OFF	OFF	OFF	OFF	Adresse 48
OFF	OFF	ON	ON	OFF	OFF	OFF	ON	Adresse 49
OFF	OFF	ON	ON	OFF	OFF	ON	OFF	Adresse 50
OFF	OFF	ON	ON	OFF	OFF	ON	ON	Adresse 51
OFF	OFF	ON	ON	OFF	ON	OFF	OFF	Adresse 52
OFF	OFF	ON	ON	OFF	ON	OFF	ON	Adresse 53
OFF	OFF	ON	ON	OFF	ON	ON	OFF	Adresse 54
OFF	OFF	ON	ON	OFF	ON	ON	ON	Adresse 55
OFF	OFF	ON	ON	ON	OFF	OFF	OFF	Adresse 56
OFF	OFF	ON	ON	ON	OFF	OFF	ON	Adresse 57
OFF	OFF	ON	ON	ON	OFF	ON	OFF	Adresse 58
OFF	OFF	ON	ON	ON	OFF	ON	ON	Adresse 59
OFF	OFF	ON	ON	ON	ON	OFF	OFF	Adresse 60
OFF	OFF	ON	ON	ON	ON	OFF	ON	Adresse 61
OFF	OFF	ON	ON	ON	ON	ON	OFF	Adresse 62
OFF	OFF	ON	ON	ON	ON	ON	ON	Adresse 63
OFF	ON	OFF	OFF	OFF	OFF	OFF	OFF	Adresse 64
OFF	ON	OFF	OFF	OFF	OFF	OFF	ON	Adresse 65
OFF	ON	OFF	OFF	OFF	OFF	ON	OFF	Adresse 66
OFF	ON	OFF	OFF	OFF	OFF	ON	ON	Adresse 67
OFF	ON	OFF	OFF	OFF	ON	OFF	OFF	Adresse 68
OFF	ON	OFF	OFF	OFF	ON	OFF	ON	Adresse 69
OFF	ON	OFF	OFF	OFF	ON	ON	OFF	Adresse 70
OFF	ON	OFF	OFF	OFF	ON	ON	ON	Adresse 71
OFF	ON	OFF	OFF	ON	OFF	OFF	OFF	Adresse 72
OFF	ON	OFF	OFF	ON	OFF	OFF	ON	Adresse 73
OFF	ON	OFF	OFF	ON	OFF	ON	OFF	Adresse 74
OFF	ON	OFF	OFF	ON	OFF	ON	ON	Adresse 75
OFF	ON	OFF	OFF	ON	ON	OFF	OFF	Adresse 76
OFF	ON	OFF	OFF	ON	ON	OFF	ON	Adresse 77
OFF	ON	OFF	OFF	ON	ON	ON	OFF	Adresse 78
OFF	ON	OFF	OFF	ON	ON	ON	ON	Adresse 79
OFF	ON	OFF	ON	OFF	OFF	OFF	OFF	Adresse 80
OFF	ON	OFF	ON	OFF	OFF	OFF	ON	Adresse 81
OFF	ON	OFF	ON	OFF	OFF	ON	OFF	Adresse 82

ADRESSEKONFIGURATION (DIP 3)

SW 8	SW 7	SW 6	SW 5	SW 4	SW 3	SW 2	SW 1	Adresse
OFF	ON	OFF	ON	OFF	OFF	ON	ON	Adresse 83
OFF	ON	OFF	ON	OFF	ON	OFF	OFF	Adresse 84
OFF	ON	OFF	ON	OFF	ON	OFF	ON	Adresse 85
OFF	ON	OFF	ON	OFF	ON	ON	OFF	Adresse 86
OFF	ON	OFF	ON	OFF	ON	ON	ON	Adresse 87
OFF	ON	OFF	ON	ON	OFF	OFF	OFF	Adresse 88
OFF	ON	OFF	ON	ON	OFF	OFF	ON	Adresse 89
OFF	ON	OFF	ON	ON	OFF	ON	OFF	Adresse 90
OFF	ON	OFF	ON	ON	OFF	ON	ON	Adresse 91
OFF	ON	OFF	ON	ON	ON	OFF	OFF	Adresse 92
OFF	ON	OFF	ON	ON	ON	OFF	ON	Adresse 93
OFF	ON	OFF	ON	ON	ON	ON	OFF	Adresse 94
OFF	ON	OFF	ON	ON	ON	ON	ON	Adresse 95
OFF	ON	ON	OFF	OFF	OFF	OFF	OFF	Adresse 96
OFF	ON	ON	OFF	OFF	OFF	OFF	ON	Adresse 97
OFF	ON	ON	OFF	OFF	OFF	ON	OFF	Adresse 98
OFF	ON	ON	OFF	OFF	OFF	ON	ON	Adresse 99
OFF	ON	ON	OFF	OFF	ON	OFF	OFF	Adresse 100
OFF	ON	ON	OFF	OFF	ON	OFF	ON	Adresse 101
OFF	ON	ON	OFF	OFF	ON	ON	OFF	Adresse 102
OFF	ON	ON	OFF	OFF	ON	ON	ON	Adresse 103
OFF	ON	ON	OFF	ON	OFF	OFF	OFF	Adresse 104
OFF	ON	ON	OFF	ON	OFF	OFF	ON	Adresse 105
OFF	ON	ON	OFF	ON	OFF	ON	OFF	Adresse 106
OFF	ON	ON	OFF	ON	OFF	ON	ON	Adresse 107
OFF	ON	ON	OFF	ON	ON	OFF	OFF	Adresse 108
OFF	ON	ON	OFF	ON	ON	OFF	ON	Adresse 109
OFF	ON	ON	OFF	ON	ON	ON	OFF	Adresse 110
OFF	ON	ON	OFF	ON	ON	ON	ON	Adresse 111
OFF	ON	ON	ON	OFF	OFF	OFF	OFF	Adresse 112
OFF	ON	ON	ON	OFF	OFF	OFF	ON	Adresse 113
OFF	ON	ON	ON	OFF	OFF	ON	OFF	Adresse 114
OFF	ON	ON	ON	OFF	OFF	ON	ON	Adresse 115
OFF	ON	ON	ON	OFF	ON	OFF	OFF	Adresse 116
OFF	ON	ON	ON	OFF	ON	OFF	ON	Adresse 117
OFF	ON	ON	ON	OFF	ON	ON	OFF	Adresse 118
OFF	ON	ON	ON	OFF	ON	ON	ON	Adresse 119
OFF	ON	ON	ON	ON	OFF	OFF	OFF	Adresse 120
OFF	ON	ON	ON	ON	OFF	OFF	ON	Adresse 121
OFF	ON	ON	ON	ON	OFF	ON	OFF	Adresse 122
OFF	ON	ON	ON	ON	OFF	ON	ON	Adresse 123
OFF	ON	ON	ON	ON	ON	OFF	OFF	Adresse 124
OFF	ON	ON	ON	ON	ON	OFF	ON	Adresse 125
OFF	ON	ON	ON	ON	ON	ON	OFF	Adresse 126

ADRESSEKONFIGURATION (DIP 3)

SW 8	SW 7	SW 6	SW 5	SW 4	SW 3	SW 2	SW 1	Adresse
OFF	ON	ON	ON	ON	ON	ON	ON	Adresse 127
ON	OFF	OFF	OFF	OFF	OFF	OFF	OFF	Adresse 128
ON	OFF	OFF	OFF	OFF	OFF	OFF	ON	Adresse 129
ON	OFF	OFF	OFF	OFF	OFF	ON	OFF	Adresse 130
ON	OFF	OFF	OFF	OFF	OFF	ON	ON	Adresse 131
ON	OFF	OFF	OFF	OFF	ON	OFF	OFF	Adresse 132
ON	OFF	OFF	OFF	OFF	ON	OFF	ON	Adresse 133
ON	OFF	OFF	OFF	OFF	ON	ON	OFF	Adresse 134
ON	OFF	OFF	OFF	OFF	ON	ON	ON	Adresse 135
ON	OFF	OFF	OFF	ON	OFF	OFF	OFF	Adresse 136
ON	OFF	OFF	OFF	ON	OFF	OFF	ON	Adresse 137
ON	OFF	OFF	OFF	ON	OFF	ON	OFF	Adresse 138
ON	OFF	OFF	OFF	ON	OFF	ON	ON	Adresse 139
ON	OFF	OFF	OFF	ON	ON	OFF	OFF	Adresse 140
ON	OFF	OFF	OFF	ON	ON	OFF	ON	Adresse 141
ON	OFF	OFF	OFF	ON	ON	ON	OFF	Adresse 142
ON	OFF	OFF	OFF	ON	ON	ON	ON	Adresse 143
ON	OFF	OFF	ON	OFF	OFF	OFF	OFF	Adresse 144
ON	OFF	OFF	ON	OFF	OFF	OFF	ON	Adresse 145
ON	OFF	OFF	ON	OFF	OFF	ON	OFF	Adresse 146
ON	OFF	OFF	ON	OFF	OFF	ON	ON	Adresse 147
ON	OFF	OFF	ON	OFF	ON	OFF	OFF	Adresse 148
ON	OFF	OFF	ON	OFF	ON	OFF	ON	Adresse 149
ON	OFF	OFF	ON	OFF	ON	ON	OFF	Adresse 150
ON	OFF	OFF	ON	OFF	ON	ON	ON	Adresse 151
ON	OFF	OFF	ON	ON	OFF	OFF	OFF	Adresse 152
ON	OFF	OFF	ON	ON	OFF	OFF	ON	Adresse 153
ON	OFF	OFF	ON	ON	OFF	ON	OFF	Adresse 154
ON	OFF	OFF	ON	ON	OFF	ON	ON	Adresse 155
ON	OFF	OFF	ON	ON	ON	OFF	OFF	Adresse 156
ON	OFF	OFF	ON	ON	ON	OFF	ON	Adresse 157
ON	OFF	OFF	ON	ON	ON	ON	OFF	Adresse 158
ON	OFF	OFF	ON	ON	ON	ON	ON	Adresse 159
ON	OFF	ON	OFF	OFF	OFF	OFF	OFF	Adresse 160
ON	OFF	ON	OFF	OFF	OFF	OFF	ON	Adresse 161
ON	OFF	ON	OFF	OFF	OFF	ON	OFF	Adresse 162
ON	OFF	ON	OFF	OFF	OFF	ON	ON	Adresse 163
ON	OFF	ON	OFF	OFF	ON	OFF	OFF	Adresse 164
ON	OFF	ON	OFF	OFF	ON	OFF	ON	Adresse 165
ON	OFF	ON	OFF	OFF	ON	ON	OFF	Adresse 166
ON	OFF	ON	OFF	OFF	ON	ON	ON	Adresse 167
ON	OFF	ON	OFF	ON	OFF	OFF	OFF	Adresse 168
ON	OFF	ON	OFF	ON	OFF	OFF	ON	Adresse 169
ON	OFF	ON	OFF	ON	OFF	ON	OFF	Adresse 170

ADRESSEKONFIGURATION (DIP 3)								
SW 8	SW 7	SW 6	SW 5	SW 4	SW 3	SW 2	SW 1	Adresse
ON	OFF	ON	OFF	ON	OFF	ON	ON	Adresse 171
ON	OFF	ON	OFF	ON	ON	OFF	OFF	Adresse 172
ON	OFF	ON	OFF	ON	ON	OFF	ON	Adresse 173
ON	OFF	ON	OFF	ON	ON	ON	OFF	Adresse 174
ON	OFF	ON	OFF	ON	ON	ON	ON	Adresse 175
ON	OFF	ON	ON	OFF	OFF	OFF	OFF	Adresse 176
ON	OFF	ON	ON	OFF	OFF	OFF	ON	Adresse 177
ON	OFF	ON	ON	OFF	OFF	ON	OFF	Adresse 178
ON	OFF	ON	ON	OFF	OFF	ON	ON	Adresse 179
ON	OFF	ON	ON	OFF	ON	OFF	OFF	Adresse 180
ON	OFF	ON	ON	OFF	ON	OFF	ON	Adresse 181
ON	OFF	ON	ON	OFF	ON	ON	OFF	Adresse 182
ON	OFF	ON	ON	OFF	ON	ON	ON	Adresse 183
ON	OFF	ON	ON	ON	OFF	OFF	OFF	Adresse 184
ON	OFF	ON	ON	ON	OFF	OFF	ON	Adresse 185
ON	OFF	ON	ON	ON	OFF	ON	OFF	Adresse 186
ON	OFF	ON	ON	ON	OFF	ON	ON	Adresse 187
ON	OFF	ON	ON	ON	ON	OFF	OFF	Adresse 188
ON	OFF	ON	ON	ON	ON	OFF	ON	Adresse 189
ON	OFF	ON	ON	ON	ON	ON	OFF	Adresse 190
ON	OFF	ON	ON	ON	ON	ON	ON	Adresse 191
ON	ON	OFF	OFF	OFF	OFF	OFF	OFF	Adresse 192
ON	ON	OFF	OFF	OFF	OFF	OFF	ON	Adresse 193
ON	ON	OFF	OFF	OFF	OFF	ON	OFF	Adresse 194
ON	ON	OFF	OFF	OFF	OFF	ON	ON	Adresse 195
ON	ON	OFF	OFF	OFF	ON	OFF	OFF	Adresse 196
ON	ON	OFF	OFF	OFF	ON	OFF	ON	Adresse 197
ON	ON	OFF	OFF	OFF	ON	ON	OFF	Adresse 198
ON	ON	OFF	OFF	OFF	ON	ON	ON	Adresse 199
ON	ON	OFF	OFF	ON	OFF	OFF	OFF	Adresse 200
ON	ON	OFF	OFF	ON	OFF	OFF	ON	Adresse 201
ON	ON	OFF	OFF	ON	OFF	ON	OFF	Adresse 202
ON	ON	OFF	OFF	ON	OFF	ON	ON	Adresse 203
ON	ON	OFF	OFF	ON	ON	OFF	OFF	Adresse 204
ON	ON	OFF	OFF	ON	ON	OFF	ON	Adresse 205
ON	ON	OFF	OFF	ON	ON	ON	OFF	Adresse 206
ON	ON	OFF	OFF	ON	ON	ON	ON	Adresse 207
ON	ON	OFF	ON	OFF	OFF	OFF	OFF	Adresse 208
ON	ON	OFF	ON	OFF	OFF	OFF	ON	Adresse 209
ON	ON	OFF	ON	OFF	OFF	ON	OFF	Adresse 210
ON	ON	OFF	ON	OFF	OFF	ON	ON	Adresse 211
ON	ON	OFF	ON	OFF	ON	OFF	OFF	Adresse 212
ON	ON	OFF	ON	OFF	ON	OFF	ON	Adresse 213
ON	ON	OFF	ON	OFF	ON	ON	OFF	Adresse 214

ADRESSEKONFIGURATION (DIP 3)								
SW 8	SW 7	SW 6	SW 5	SW 4	SW 3	SW 2	SW 1	Adresse
ON	ON	OFF	ON	OFF	ON	ON	ON	Adresse 215
ON	ON	OFF	ON	ON	OFF	OFF	OFF	Adresse 216
ON	ON	OFF	ON	ON	OFF	OFF	ON	Adresse 217
ON	ON	OFF	ON	ON	OFF	ON	OFF	Adresse 218
ON	ON	OFF	ON	ON	OFF	ON	ON	Adresse 219
ON	ON	OFF	ON	ON	ON	OFF	OFF	Adresse 220
ON	ON	OFF	ON	ON	ON	OFF	ON	Adresse 221
ON	ON	OFF	ON	ON	ON	ON	OFF	Adresse 222
ON	ON	OFF	ON	ON	ON	ON	ON	Adresse 223
ON	ON	ON	OFF	OFF	OFF	OFF	OFF	Adresse 224
ON	ON	ON	OFF	OFF	OFF	OFF	ON	Adresse 225
ON	ON	ON	OFF	OFF	OFF	ON	OFF	Adresse 226
ON	ON	ON	OFF	OFF	OFF	ON	ON	Adresse 227
ON	ON	ON	OFF	OFF	ON	OFF	OFF	Adresse 228
ON	ON	ON	OFF	OFF	ON	OFF	ON	Adresse 229
ON	ON	ON	OFF	OFF	ON	ON	OFF	Adresse 230
ON	ON	ON	OFF	OFF	ON	ON	ON	Adresse 231
ON	ON	ON	OFF	ON	OFF	OFF	OFF	Adresse 232
ON	ON	ON	OFF	ON	OFF	OFF	ON	Adresse 233
ON	ON	ON	OFF	ON	OFF	ON	OFF	Adresse 234
ON	ON	ON	OFF	ON	OFF	ON	ON	Adresse 235
ON	ON	ON	OFF	ON	ON	OFF	OFF	Adresse 236
ON	ON	ON	OFF	ON	ON	OFF	ON	Adresse 237
ON	ON	ON	OFF	ON	ON	ON	OFF	Adresse 238
ON	ON	ON	OFF	ON	ON	ON	ON	Adresse 239
ON	ON	ON	ON	OFF	OFF	OFF	OFF	Adresse 240
ON	ON	ON	ON	OFF	OFF	OFF	ON	Adresse 241
ON	ON	ON	ON	OFF	OFF	ON	OFF	Adresse 242
ON	ON	ON	ON	OFF	OFF	ON	ON	Adresse 243
ON	ON	ON	ON	OFF	ON	OFF	OFF	Adresse 244
ON	ON	ON	ON	OFF	ON	OFF	ON	Adresse 245
ON	ON	ON	ON	OFF	ON	ON	OFF	Adresse 246
ON	ON	ON	ON	OFF	ON	ON	ON	Adresse 247
ON	ON	ON	ON	ON	OFF	OFF	OFF	Adresse 248
ON	ON	ON	ON	ON	OFF	OFF	ON	Adresse 249
ON	ON	ON	ON	ON	OFF	ON	OFF	Adresse 250
ON	ON	ON	ON	ON	OFF	ON	ON	Adresse 251
ON	ON	ON	ON	ON	ON	OFF	OFF	Adresse 252
ON	ON	ON	ON	ON	ON	OFF	ON	Adresse 253
ON	ON	ON	ON	ON	ON	ON	OFF	Adresse 254
ON	ON	ON	ON	ON	ON	ON	ON	Adresse 255

Tab. 16

Headquarters Italy Videotec S.p.A.

Via Friuli, 6 - I-36015 Schio (VI) - Italy

Tel. +39 0445 697411 - Fax +39 0445 697414

Email: info@videotec.com

Asia Pacific Videotec (HK) Ltd

Flat 8, 19/F. On Dak Industrial Building, No. 2-6 Wah Sing Street

Kwai Chung, New Territories - Hong Kong

Tel. +852 2333 0601 - Fax +852 2311 0026

Email: info.hk@videotec.com

France Videotec France SARL

Immeuble Le Montreal, 19bis Avenue du Québec, ZA de Courtaboeuf
91140 Villebon sur Yvette - France

Tel. +33 1 60491816 - Fax +33 1 69284736

Email: info.fr@videotec.com

Americas Videotec Security, Inc.

Gateway Industrial Park, 35 Gateway Drive, Suite 100
Plattsburgh, NY 12901 - U.S.A.

Tel. +1 518 825 0020 - Fax +1 518 825 0022

Email: info.usa@videotec.com - www.videotec.us



www.videotec.com

MNVCUPTPLUS3_1511_DE



ULISSE PLUS NETCAM

Уличное устройство PTZ Full IP для сетевых телекамер
с объективами средних размеров

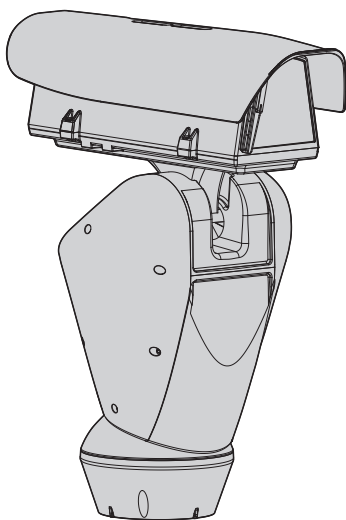

1 Информация о настоящем руководстве.....	7
1.1 Типографские обозначения.....	7
2 Примечания по авторскому праву и торговым маркам	7
3 Правила безопасности.....	7
4 Идентификация.....	10
4.1 Описание и назначение изделия.....	10
4.2 Маркировка изделия	10
4.2.1 Контроль маркировки	10
5 Версии.....	11
5.1 Встроенная щетка очиститель	11
5.2 Проекторы со LED.....	11
5.3 Версия с окошком из германия.....	11
6 Подготовка изделия к использованию	12
6.1 Меры безопасности перед использованием.....	12
6.2 Распаковка	12
6.3 Содержимое	12
6.4 Переработка в отходы в условиях безопасности материалов упаковки.....	12
6.5 Подготовительная работа перед установкой	13
6.5.1 Установка кронштейна.....	13
6.5.2 Прохождение кабелей.....	13
7 Сборка.....	14
7.6 Монтаж телекамеры к объективам с двигателями.....	14
7.6.1 Характеристики телекамер.....	14
7.6.1 Открытие корпуса	15
7.6.2 Установка телекамеры	15
7.7 Описание платы футляра.....	16
7.7.1 Подключение телекамеры и моторизованных объективов	16
7.7.2 Регулировка напряжения питания двигателей объективов	17
7.7.3 Подключение линии связи.....	17
8 Монтаж	18
8.1 Подключение к кабелям основания	18
8.2 Прикрепление основания к кронштейну	19
8.3 Описание платы разъемов	19
8.4 Подключение к линии питания	20
8.4.1 Подключение линии питания 24Vac	21
8.4.2 Подключение силовой линии в 120 В переменного тока и 230 В переменного тока.....	21
8.4.3 Подключение входов сигналов тревоги, сумеречного выключателя и реле	22
8.5 Подключение кабеля к сети Ethernet.....	22
8.6 Крепление верхнего корпуса.....	23
8.7 Установка светодиодных (LED) осветителей	24
8.7.1 Установка скобы.....	24

8.7.2 Установка осветителя на скобе	24
8.8 Подключение светодиодных (LED) осветителей	25
8.9 Пакетик с осушителем	26
8.10 Установка светодиодных (LED) осветителей и режим синхронизации с телекамерой	26
8.10.1 Описание светодиодного (LED) осветителя	26
8.10.2 Синхронизация с внешним сумеречным выключателем	27
8.10.3 Синхронизируйте узел с LED осветителями	27
8.10.4 Ручная активация LED осветителя	27
8.10.5 Регулировка порога включения светодиодных (LED) осветителей	28
8.10.6 Регулировка мощности светодиодных (LED) осветителей	28
8.11 Конфигурация аппаратного обеспечения	29
8.11.1 Открытие конфигурационной дверцы	29
8.11.2 Конфигурация DIP1	29
8.11.3 Конфигурация DIP2	29
8.11.4 Конфигурация DIP3	30
8.11.4.1 Установка адреса	30
8.11.4.2 Конфигурация серийные линии связи	30
8.11.5 Конфигурация DIP4	30
9 Включение	31
10 Конфигурация	32
10.1 Интерфейс веб	32
10.1.1 Первый доступ	32
10.1.2 Home	32
10.1.3 Проверки пользователя	33
10.1.4 Параметры Устройства	34
10.1.5 Статистика Устройства	34
10.1.6 Конфигурация сети	34
10.1.7 Конфигурация пользователей	35
10.1.8 Параметры Движения	35
10.1.8.1 Autopan	36
10.1.8.2 Patrol	36
10.1.8.3 Вызов Движений	36
10.1.9 Параметры Предварительных настроек (Preset)	36
10.1.10 Параметры Предварительных настроек (Дополнительно)	36
10.1.11 Цифровые входы/выходы	37
10.1.12 Washer	37
10.1.13 Параметры Камеры	38
10.1.14 Инструменты	38
10.1.15 Factory Default	39
10.2 VTTunnel	39
11 Аксессуары	40
11.1 Установка мойки	40
11.1.1 Подключение моющего оборудования	40
11.2 Настенное крепление	41
11.3 Кронштейн для поручней	41
11.4 Блок питания с функцией контроля осветителей	41
12 Инструкции по исключительному функционированию	42

12.1	Изменяет режим связи (от протокола ONVIF до последовательного телеуправления)	42
12.1.1	Процедура изменения режима связи.....	42
13	Техобслуживание.....	43
13.1	Замена предохранители.....	43
14	Уборка	43
14.1	Очистка стекла и пластмассовых частей	43
14.2	Очистка стеклянного окошка с содержанием германия.....	43
15	Вывоз в отходы	43
16	Устранение неисправностей.....	44
17	Технические параметры	45
17.1	Общее	45
17.2	Механика.....	45
17.3	Электрические характеристики	46
17.4	Сообщения	46
17.5	Протоколы	46
17.6	Среда.....	46
17.7	Сертификация	46
18	Технические чертежи	47
A	Приложение - Таблица адресов	50

1 Информация о настоящем руководстве

Перед монтажом и использованием настоящего блока, внимательно прочитайте настоящее руководство. Хранить данное руководство под рукой для будущих консультаций.

1.1 Типографские обозначения



ОПАСНОСТЬ!

Повышенная опасность.

Опасность удара электрическим током. Если не указано иным образом, отключите питание, прежде чем приступить к выполнению операций, если не указано иным образом, отключите питание.



ОПАСНОСТЬ!

Горячая поверхность.

Следует избегать контакта. Горячие поверхности могут причинить поражения человеку в случае контакта.



ОПАСНОСТЬ!

Опасность механической природы. Риск раздавливания или отрезания.



ПРЕДУПРЕЖДЕНИЕ!

Средняя опасность.

Эта операция очень важна для правильной работы системы. Просим внимательно прочитать приведенную процедуру и выполнить ее указанным способом.



INFO

Описание характеристик системы. Рекомендуется внимательно для выполнения следующих фаз.

2 Примечания по авторскому праву и торговым маркам

Упомянутые название компаний и продукции являются торговыми марками или зарегистрированными торговыми марками, принадлежащими соответствующим компаниям.

3 Правила безопасности



ПРЕДУПРЕЖДЕНИЕ! Система электропитания, к которой подключен прибор, должен быть оснащена биполярный автоматический выключатель защиты макс. 20А. Этот выключатель выбирается из перечисленных в списке. Минимальное расстояние между контактами должно быть 3mm. Выключатель должен иметь защиту против пробоя тока на землю (дифференциальную) и сверхток (магнитотермический).



ПРЕДУПРЕЖДЕНИЕ! Опасные движущиеся компоненты. Не приближать пальцы или другие части тела.



ПРЕДУПРЕЖДЕНИЕ! Следует использовать только кронштейны или принадлежности, рекомендуемые для монтажа.



ПРЕДУПРЕЖДЕНИЕ! Во избежание пожароопасности, заменяйте плавкие предохранители такими же, аналогичного типа и значения тока. Замена плавких предохранителей должна выполняться только квалифицированным персоналом.



ПРЕДУПРЕЖДЕНИЕ! Установка типа TNV-1. Не подключайте к системам SELV.



ПРЕДУПРЕЖДЕНИЕ! Для снижения опасности пожара пользуйтесь исключительно кабелями, имеющими сертификат UL Listed или CSA, имеющими размеры не менее 0,13mm² (26AWG).

- Производитель снимает с себя какую-либо ответственность за возможный ущерб, вызванный использованием не по назначению упомянутого в данном руководстве оборудования. Также сохраняется право изменять содержание без предварительного извещения. При тщательном сборе документации, содержащейся в настоящем руководстве, были сделаны все необходимые проверки. Производитель, однако, не может взять на себя какую-либо ответственность, связанную с его использованием. Это относится к любому лицу или обществу, вовлеченному в создание и производство данного руководства.

- Перед началом любой операции, убедитесь, что электропитание отключено.
- Не использовать кабели со следами повреждений или старения.
- Ни в коем случае не вносить изменений и не выполнять подключений, не предусмотренных данным руководством. Использование оборудования не по назначению, может привести к серьёзным рискам и опасно, как для персонала, так и для системы.
- Используйте только оригинальные запасные части. Номера для оригинальных запасных частей может привести к пожару, электрический разряд или других опасностей.
- Перед монтажом проверить, что поставляемый материал соответствует требуемым техническим спецификациям, проверив этикетки маркировки (4.2 Маркировка изделия, страница 10).
- Это устройство предназначено для постоянно действующей установки на здании или на соответствующей конструкции. Устройство должно быть установлено на постоянной основе перед выполнением любой операции.
- Категория установки (называемая также категория перенапряжения) указывает уровни скачков напряжения сети, которым подвержен прибор. Категория зависит от места установки и присутствия устройств защиты от перенапряжений. Устройство для промышленных условий, подключенное к основным ответвлениям линии питания, относится к категории установки III. Если речь идет о данном случае, требуется уменьшение до категории II. Этого можно достичь с помощью разделительного трансформатора с заземленным экраном между первичной и вторичной обмоткой или с помощью устройств защиты от перенапряжений (SPD) с маркировкой UL, подключенных между фазой и нейтралью и между нейтралью и землей. Устройства SPD с маркировкой UL используются для повторяющегося подавления кратковременных перенапряжений и при следующих номинальных условиях функционирования: Тип 2 (Устройства SPD, постоянно подключенные к сети питания, для установки со стороны загрузки рабочего устройства); Номинальный ток разряда (I_n) минимум 20кА Например, можно использовать: FERRAZ SHAWMUT, ST23401PG-CN, ST240SPG-CN, указанные для 120/240Vac, ($I_n=20кА$). Максимальное расстояние между установкой и переходником составляет 5м.
- Для изделий с маркировкой UL, питающихся от источника 24Vac, используйте трансформатор из списка UL класса 2, соответствующий действующим нормативам.
- Размыкающее устройство, с быстрым и лёгким доступом, предназначенное для встраивания в электросистему здания и обеспечивающее быстрое срабатывание.
- Вывод заземления, присутствующий в изделии, должен быть постоянно подключен к земле.
- Подключите устройство к источнику питания, который соответствует маркировке. Прежде чем приступить к установке, убедитесь, что линия электропередачи правильно секционирована. Напряжение питания не должно превышать предельных ($\pm 10\%$).
- Питание должно подаваться от отдельного источника типа SELV, 24Vac, 8A, идущего от трансформатора с двойной изоляцией, зарегистрированного в списке UL, соответственно защищенного на выходе.
- Устройство устанавливается так, чтобы доступ к нему мог иметь только технический персонал или монтажник, поскольку из-за наличия подвижных частей существует опасность травмирования в результате движения этих подвижных компонентов.
- Наклейте этикетку Опасные Подвижные Компоненты рядом с устройством (Рис. 5, страница 12).
- Не используйте прибор в присутствии воспламеняющихся веществ.
- Для подключения линии питания используйте специальную соединительную коробку (UPTJBUL). Для получения дополнительной информации смотреть руководство по эксплуатации и установки изделия.

- Не разрешайте пользоваться прибором детям или посторонним лицам.
- Прибор считается отключенным только тогда, когда питание отключено и соединительные кабели с другими устройствами убраны.
- Техобслуживание прибора должно выполняться только квалифицированным персоналом. Во время техобслуживания оператор подвержен риску поражения электрическим током и другим опасностям.
- Используйте только комплектующие, указанные изготовителем. Любое изменение, выполненное без разрешения изготовителя, ведёт к потере гарантии.
- Перед подключением всех кабелей сигнала проверьте, чтобы узел был соответственно подключен к заземлению.
- Если устройство необходимо снять с установки, всегда в последнюю очередь отсоединяйте кабель заземления.
- Примите соответствующие меры для предупреждения повреждений аппаратуры электростатическими разрядами.
- Узел реализован для подключения посредством трехжильного кабеля. Для правильного подключения контура заземления придерживайтесь указаний, содержащихся в данном руководстве.
- Обращайтесь с прибором осторожно, сильные механические воздействия могут его повредить.
- Обратите особое внимание на изоляцию и расстояния между линией питания и всеми другими кабелями, в том числе устройствами защиты от молний.
- Можно транспортировать устройство только с максимальной аккуратностью. Резкие остановки, перепады уровней и сильные столкновения могут приводить к повреждениям устройства или травмированию пользователя.

4 Идентификация

4.1 Описание и назначение изделия

ULISSE MAXI NETCAM - мощное устройство PTZ Full-IP для применения для внешнего наблюдения IP, в состоянии управлять современными видеокамерами IP SD, HD и Megapixel, интегрируясь в сетевую систему.

Данная модель может содержать телекамеры с объективами средних размеров, обеспечивая непрерывное динамичное наблюдение больших внешних пространств на 360°.

Особенностью ULISSE PLUS NETCAM является возможность простого сетевого управления всеми функциями телекамеры и поворотного устройства, в том числе стеклоочистителей, предварительных настроек и set-up, используя наиболее распространенные на рынке VMS. Можно использовать любую телекамеру, совместимую со стандартом ONVIF, профиль S, или патентованным протоколом RS-485, в то время как полное управление системой требует только адреса IP.

Узел укомплектован стеклоочистителем для чистки переднего стекла от пыли и дождя; имеется широкий выбор канистр с насосом стеклоочистителя разных объемов и с разным напором.

Для обеспечения детальных изображений также и в ночное время имеются версии со светодиодными осветителями, с инфракрасным или белым светом.

Аккуратная конструкция top-mount гарантирует загоризонтный обзор и непрерывное вращение вокруг горизонтальной оси, объединяет высокую скорость и абсолютную точность наводки как в ручном режиме, так и в дозорном функционировании.

ULISSE PLUS укомплектовано оптическими энкодерами, обеспечивающими точный контроль положения в любых условиях эксплуатации.

4.2 Маркировка изделия



На поворотные устройства наклеены этикетки, соответствующие маркировке ЕС.



Рис. 1

На этикетке указаны:

- Идентификационный код модели (Расширенный штрих-код 3/9).
- Питание (Volt).
- Частота (Hertz).
- Потребление тока (Ампер).
- Степень защиты (IP).
- Серийный номер.

4.2.1 Контроль маркировки

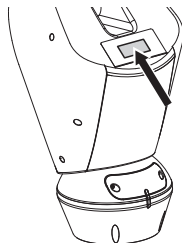
До начала установки проверьте, изучив для этого маркировочные этикетки, чтобы поставленный материал соответствовал специальным требованиям.

Ни в коем случае не вносить изменений и не выполнять подключений, не предусмотренных данным руководством. Использование оборудования не по назначению, может привести к серьезным рискам и опасно, как для персонала, так и для системы.

5 Версии

5.1 Встроенная щетка очиститель

Устройство может быть оснащено очистителем стекла.



Рис. 2

i За дополнительной информацией обратитесь к соответствующей главе (10.1.3 Проверки пользователя, страница 33).

Поворотное устройство может быть укомплектовано внешним насосом для очистки стекла.

i За дополнительной информацией обратитесь к соответствующей главе (11.1 Установка мойки, страница 40).

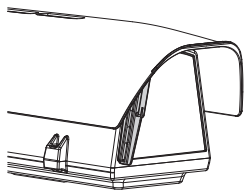
5.2 Проекторы со LED



Версия со светодиодными (LED) осветителями может получать питание только 24Vac.

Поворотное устройство может быть укомплектовано кронштейном для установки 2 светодиодных (LED) осветителей VIDEOTECS для ночного видения (осветители не входят).



Рис. 3

i За дополнительной информацией обратитесь к соответствующей главе (8.7 Установка светодиодных (LED) осветителей, страница 24).

5.3 Версия с окошком из германия

Версия с окошком из германия предназначена для приложений с тепловизионными камерами.

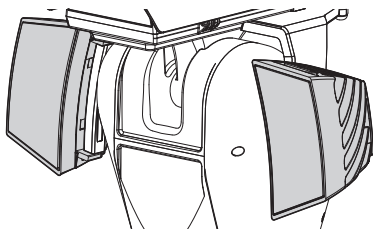

Рис. 4

6 Подготовка изделия к использованию



Любое изменение, выполненное без разрешения изготовителя, ведёт к потере гарантии.

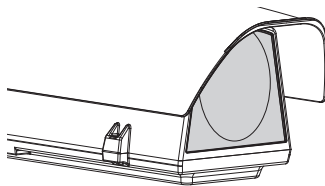

Устройство не должны быть демонтированы или подделаны. Исключение составляют лишь те, которые касаются операций по сборке и техническому обслуживанию, предусмотренные в данном руководстве.

6.1 Меры безопасности перед использованием



Оборудование включает в себя подвижные компоненты. Проверить, чтобы блок был установлен в зоне, недоступной во время нормальной работы оборудования. Поместить специальную табличку, поставляемую вместе с оборудованием, на хорошо видимом месте в непосредственной близости к нему.



Рис. 5

6.2 Распаковка

При поставке изделия убедитесь в том, что упаковка не повреждена и не имеет явных признаков падений или царапин.

В случае видимых повреждений упаковки немедленно свяжитесь с поставщиком.

Храните упаковку на случай, если необходимо отправка изделия для ремонта.



Распаковывайте крышку устройства осторожно, чтобы не повредить футляр.

6.3 Содержимое

Убедитесь в том, что содержимое будет соответствовать списку материалов, приведённому ниже:

- Устройство позиционирования
- Основание питания
- Упаковка аксессуары:
 - Серийный адаптер
 - Последовательный кабель-удлинитель
 - Ключи шестигранные
 - Распорки (не присутствует в версиях с интегрированной телекамерой)
 - Этикетка
 - Хомутики
 - Силиконовая оболочка
 - Уплотнители уменьшения для кабельных муфт.
 - Учебник инструкции
 - Пластина фиксации для пакетика с осушителем (не присутствует в версиях со светодиодными (LED) осветителями)
 - Пакетик с осушителем
 - Набор винтов
- Скоба для крепления светодиодных (LED) осветителей (присутствует в версиях со светодиодными (LED) осветителями)
- Тент от солнца

6.4 Переработка в отходы в условиях безопасности материалов упаковки

Материалы упаковки полностью состоят из рекуперируемого материала. Техник по установке должен переработать их в отходы в соответствии с порядком дифференцированного сбора или, в любом случае, в соответствии действующими правилами в стране использования.

В случае возврата некачественной продукции, рекомендуем использовать первоначальную оригинальную упаковку для транспортировки.

6.5 Подготовительная работа перед установкой

6.5.1 Установка кронштейна

В наличии разные типы кронштейнов (11 Аксессуары, страница 40). Выберите наиболее подходящий для монтажа и следуйте всем указаниям, приведенным в данном разделе.

Обратите особое внимание на системы крепления аппаратуры. Система креплений должна выдерживать вес, не менее чем 4-кратно превышающий вес самой аппаратуры, в том числе поворотного устройства, объектива и телекамеры.

Устройство должно устанавливаться в вертикальном положении. Каждое альтернативное расположение может ухудшить характеристики аппаратуры.

Не устанавливайте устройство перевернутым.

6.5.2 Прохождение кабелей

Соединительные кабели не должны быть доступными извне. Во избежание случайного выскальзывания из-за избыточного веса кабели должны быть как следует прикреплены к поддержке.

Используемые кабели должны соответствовать типу установки.

Уложите кабели внутри кронштейна так, чтобы они выходили наружу примерно на 50 см.



Рис. 6

7 Сборка

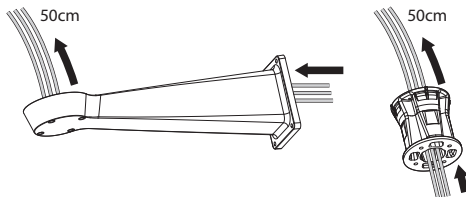

Могут быть установлены только сетевые телекамеры с определенными техническими характеристиками (7.6.1 Характеристики телекамер, страница 14).

7.6 Монтаж телекамеры к объективам с двигателями



Исправная работа оборудования в указанном диапазоне температуры гарантируется только в том случае, если используются видеокамера и объектив для пределов температуры от -10°C до $+60^{\circ}\text{C}$.

Установка телекамеры и соответствующих объективов выполняется силами заказчика.

7.6.1 Характеристики телекамер



Исправная работа оборудования в указанном диапазоне температуры гарантируется только в том случае, если используются видеокамера и объектив для пределов температуры от -10°C до $+60^{\circ}\text{C}$.



Телекамера должна быть предварительно конфигурирована, чтобы получить IP-адрес с помощью DHCP.



Телекамера должна быть предварительно конфигурирована, чтобы состыковаться с сервером NTP с помощью DHCP. Если конфигурация NTP посредством DHCP невозможна, установите следующий статический адрес сервера NTP: 192.0.0.1.



В узле могут быть установлены только сетевые телекамеры.

- Могут быть установлены только телекамеры с коммуникационным портом Ethernet типа 100 baseTx.
- Могут быть установлены только телекамеры, оснащенные клеммой питания. Поворотное устройство не может подавать питание непосредственно на кабель Ethernet (Power over Ethernet).
- Напряжение питания телекамеры должно быть 12Vdc.
- Максимальный потребляемый ток телекамеры должен быть менее 800mA.
- Протокол связи должен быть ONVIF, профиль S. Телекамера должна быть предварительно конфигурирована, чтобы поддерживать связь с помощью протокола ONVIF, профиль S.
- Телекамера должна быть в состоянии правильно функционировать при температурах от -10°C до $+60^{\circ}\text{C}$

7.6.1 Открытие корпуса

Чтобы открыть футляр, отвинтите винты, установленные на боковых поверхностях, и поднимите верхний корпус.



Рис. 7



Как только верхняя часть футляра будет снята, придерживайте ее до тех пор, пока крепежный кабель не будет натянут. Не роняйте верхнюю часть футляра, поскольку ее вес может повредить кабель.

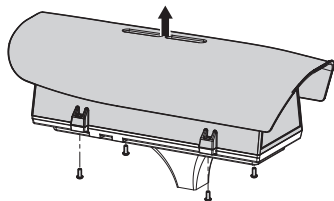

По завершении операций по установке и прокладке кабеля закройте устройство.

7.6.2 Установка телекамеры

Извлеките внутренние опорные салазки (01), отвинтив крепежные винты (02). Прикрепите телекамеру с помощью винта 1/4" (03). Отрегулируйте внутренние салазки для получения правильного положения объектива и телекамеры.

Закрепите регулируемые салазки в правильном положении с помощью специальных винтов. Для расположения телекамеры можно использовать также распорки, входящие в комплект поставки.



Рис. 8

Установите на место внутренние салазки, затянув ранее ослабленные винты.

7.7 Описание платы футляра

ОПИСАНИЕ ПЛАТЫ

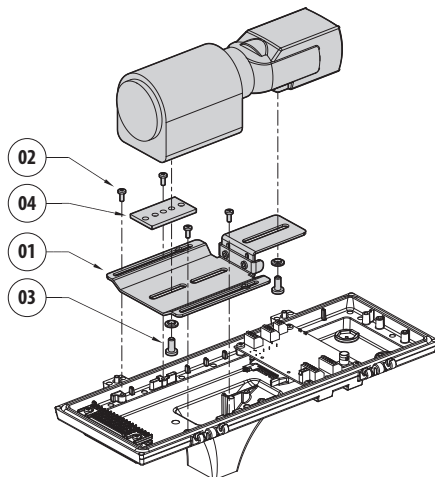
Разъём/Клемма	Функция
CN1	Не используется
CN2	Разъём для управления моторизованными объективами
CN3	Разъём для потенциометров моторизованных объективов
CN6	Не используется
CN7	Напряжение питания камеры, линии дополнительные
DIP1	Выбор напряжения питания объективов

Таб. 1



Рис. 9

7.7.1 Подключение телекамеры и моторизованных объективов

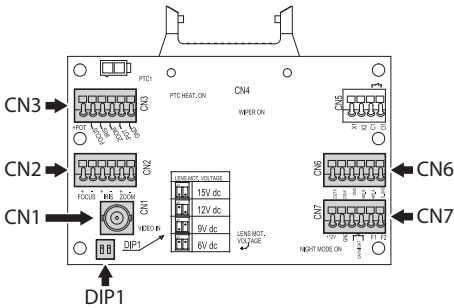

Соединения, показанные ниже, должны выполняться только опытным персоналом; при этом необходимо соблюдать все особенности прокладки кабелей и питания устройств.

Электронная плата разработана так, чтобы управлять телекамерами с моторизованными объективами (Focus, Iris, Zoom), оснащенными или нет потенциометрами для контроля достигнутого положения.

До выполнения подключений проверьте, чтобы напряжения, поступающие с платы, были в пределах, предусмотренных для аппаратуры.

РАЗЪЕМ ДЛЯ ПОДКЛЮЧЕНИЯ ТЕЛЕКАМЕРЫ К МОТОРИЗОВАННЫМ ОБЪЕКТИВАМ

Напряжение	Ток	Описание
+12V	800mA max	Напряжение питания камеры
+5V	15mA max	Питание потенциометров объективов
От 6Vdc до 15Vdc (регулирующийся)	200mA max (Focus+Zoom+Iris)	Питание двигателей объективов

Таб. 2

Объективы с двигателями на общей жиле: Выполните подключения, как показано на рисунке..

Для установки телекамеры выполните подключения как показано на рисунке.



Рис. 10 CN2.



Рис. 11 CN7.

Объективы с двигателями инверсии полярности:

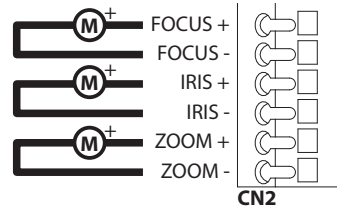
Выполните подключения, как показано на рисунке..

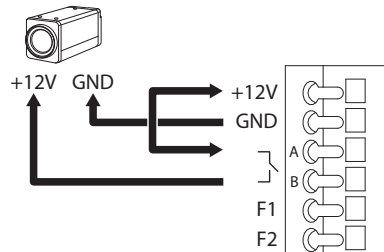

Рис. 12 CN2.

Объективы с двигателями на общей жиле:

Подключите соответствующую опцию в меню (10.1.13 Параметры Камеры, страница 38). Выполните подключения, как показано на рисунке..

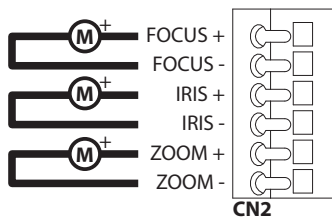

Рис. 13 CN2.

Потенциометры: Выполните подключения, как показано на рисунке..

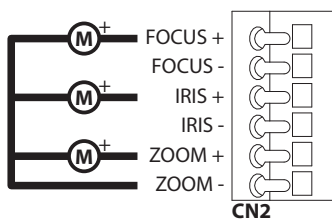

Рис. 14 CN3.

7.7.2 Регулировка напряжения питания двигателей объективов

Перед подачей напряжения на поворотное устройство установите напряжение питания объективов с помощью DIP1 (7.7 Описание платы футляра, страница 16).

РЕГУЛИРОВКА НАПЯЖЕНИЯ ПИТАНИЯ ДВИГАТЕЛЕЙ ОБЪЕКТИВОВ

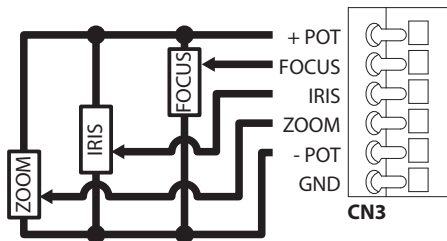
SW1	SW2	Напряжение
OFF	OFF	15Vdc
ON	OFF	12Vdc
OFF	ON	9Vdc
ON	ON	6Vdc

Таб. 3

7.7.3 Подключение линии связи

Подключите кабель Ethernet к телекамере.



Рис. 15

i Сгруппируйте излишки кабеля, чтобы предотвратить вмешательство в функционирование стеклоочистителя (в версиях оснащены).

8 Монтаж

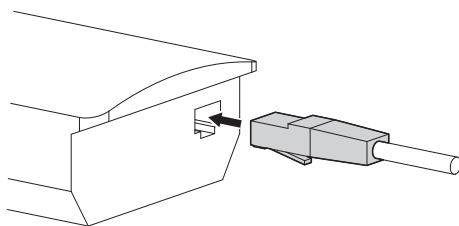

Ни в коем случае не вносить изменений и не выполнять подключений, не предусмотренных данным руководством, не соблюдении инструкций, предоставленных в руководстве и касающихся соединений, может привести к созданию серьезных опасных ситуаций для персонала и установки.



Не заменять уже имеющуюся на оборудовании кабельпроводку. Несоблюдение данной инструкции может привести к созданию серьезных опасных ситуаций для персонала и установки, а также к аннулированию гарантии.



В случае использования набора для очистки стекла держатель насадки должен устанавливаться перед установкой поворотного устройства и прокладкой кабеля. За дополнительной информацией обращаться к руководству по эксплуатации соответствующего набора.



Рис. 16



В нижнем колпаке присутствует пакетик с осушителем, предотвращающий образование влаги в основании и в области плат разъемов. Снимите пакет перед установкой.

8.1 Подключение к кабелям основания

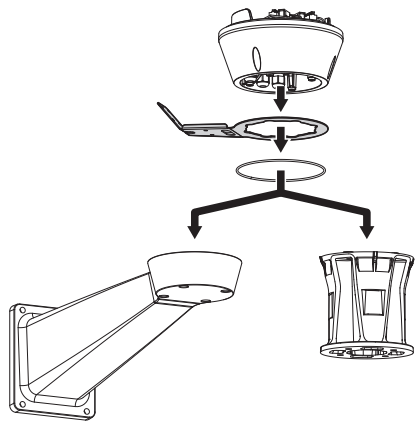
Уложите кабели в кабельные муфты и, удерживая основание на расстоянии около 20см от кронштейна Затяните кабеледержатели. Кабельные муфты подходят к кабелям, имеющим диаметр от 5mm до 10mm.



Рис. 17



Будьте осторожны при установке. Момент затяжки: 5Нм.

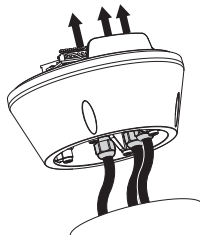

Для кабелей диаметром от 3 до 7mm используйте специальные резиновые прокладки, входящие в набор поставки.



Рис. 18

8.2 Прикрепление основания к кронштейну

Используйте винты и шайбы, поставляемые с основанием.

После установки прокладки (01) прикрепите основание (02) к кронштейну (03), используя винты, зубчатые шайбы (05) и кольца для винтов (06).

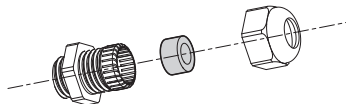

Рис. 19



Рис. 20

Выровняйте 3 отметки на основании с отметками, присутствующими на кронштейнах, как показано на следующем рисунке.

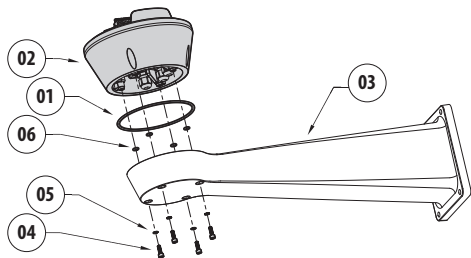

Рис. 21

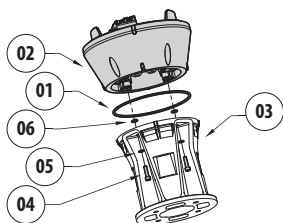
Применить резьбового фиксатора отверстия винтов (Loctite 243°).

Будьте осторожны при установке. Момент затяжки: 4Нм.

8.3 Описание платы разъемов

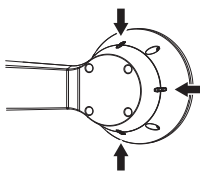
ОПИСАНИЕ ПЛАТЫ РАЗЪЕМОВ	
Разъём/Компонент	Функция
CN1	Питание платы
CN4	Кабелей сигнала
Ethernet	Ethernet
F1	Плавкий предохранитель
F2	Плавкий предохранитель

Таб. 4



Рис. 22

8.4 Подключение к линии питания

В зависимости от версии, на устройство может подаваться различное напряжение питания. Их значение приведено на идентификационной этикетке изделия (4.2 Маркировка изделия, страница 10).

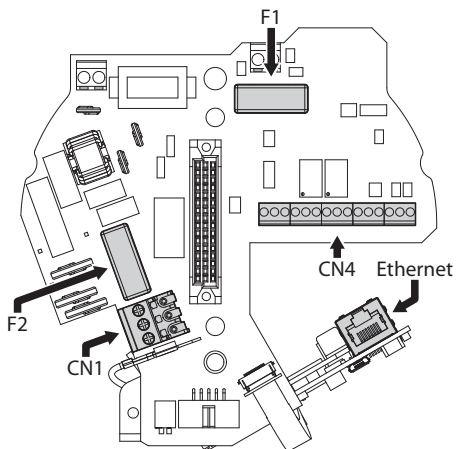

Выполнять электрические подключения при отсутствии питания и с открытым разъединяющим устройством.



В момент монтажа убедитесь в том, что характеристики подаваемого питания соответствуют характеристикам, требуемым устройством.



Проверить, что источники питания и соединительные кабели в состоянии обеспечить необходимое энергопотребление системы.



Провод заземления должен быть длиннее двух других примерно на 10мм, с целью предотвращения случайного отсоединения по причине растяжения кабеля.



Кабель питания должен быть покрыт силиконовой оболочкой (01), имеющейся в комплекте. Силиконовая оболочка крепится с помощью зажима (02).



Рис. 23

8.4.1 Подключение линии питания 24Vac

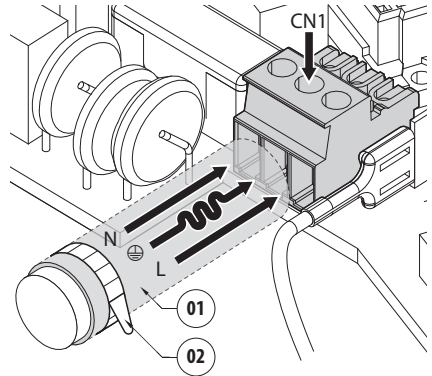

Для изделий с маркировкой UL, питающихся от источника 24Vac, используйте трансформатор из списка UL класса 2, соответствующий действующим нормативам.

Отрезать по размеру кабеля и реализовать соединения. Подключите питающую линию к следующей клемме: CN1.



Рис. 24

Подключите кабели питания, как описано в таблице ниже.

ПОДКЛЮЧЕНИЕ К ЛИНИИ ПИТАНИЯ	
Цвет	Клеммы
Питание 24Vac	
Определяется установщиком	24Vac
Определяется установщиком	24Vac
Желтый/Зеленый	⊕

Таб. 5

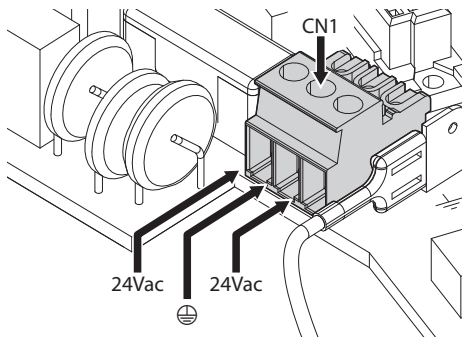
8.4.2 Подключение силовой линии в 120 В переменного тока и 230 В переменного тока

Отрезать по размеру кабеля и реализовать соединения. Подключите питающую линию к следующей клемме: CN1.



Рис. 25

Подключите кабели питания, как описано в таблице ниже.

ПОДКЛЮЧЕНИЕ К ЛИНИИ ПИТАНИЯ	
Цвет	Клеммы
Питание 230Vac	
Синий	N (Нейтраль)
Коричневый	L (Фаза)
Желтый/Зеленый	⊕
Питание 120Vac	
Синий	N (Нейтраль)
Коричневый	L (Фаза)
Желтый/Зеленый	⊕

Таб. 6

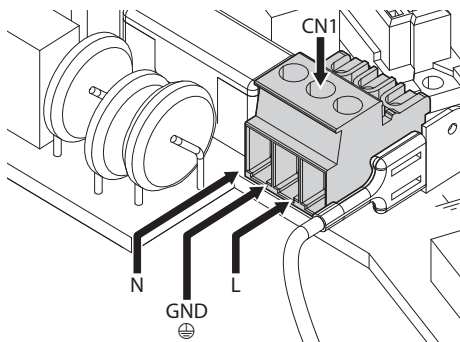
8.4.3 Подключение входов сигналов тревоги, сумеречного выключателя и реле

⚠ ПРЕДУПРЕЖДЕНИЕ! Установка типа TNV-1. Не подключайте к системам SELV.

⚠ ПРЕДУПРЕЖДЕНИЕ! Для снижения опасности пожара пользуйтесь исключительно кабелями, имеющими сертификат UL Listed или CSA, имеющими размеры не менее $0,13\text{mm}^2$ (26AWG).

Стандартную версию



Рис. 26 Подключение контактов реле.



Рис. 27 Подключение сигналов тревог.

Версия со LED осветителями

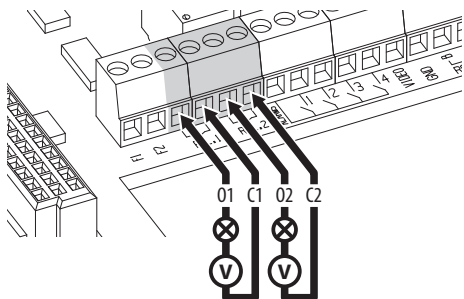
ПОДКЛЮЧЕНИЕ ВХОДОВ СИГНАЛОВ ТРЕВОГИ, СУМЕРЕЧНОГО ВЫКЛЮЧАТЕЛЯ И РЕЛЕ

AL1, AL2, AL3, AL4 и AGND	Входы аварийного сигнала с автономным питанием, отнесенные к общей клемме AGND
O1-C1 и O2-C2	Свободные контакты выхода, активируемые сигналом тревоги или командой пользователя

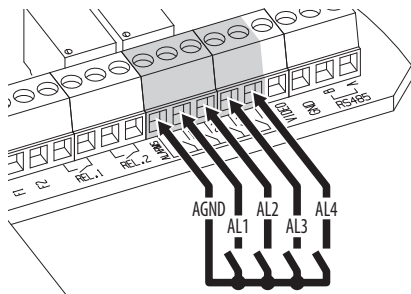
Таб. 7

i Подключите сумеречный выключатель к клеммам AGND и AL1. Контакт сигнала тревоги AL1 по умолчанию предназначен для сумеречного выключателя.

8.5 Подключение кабеля к сети Ethernet

Подключите кабель Ethernet к разъему (8.3 Описание платы разъемов, страница 19).



Рис. 28

8.6 Крепление верхнего корпуса

Прикрепите верхний корпус (01) к основанию (02) с помощью крепежных винтов (03), укомплектованных прокладками (04). Проверьте присутствие и хорошее состояние уплотнителя основания (05).

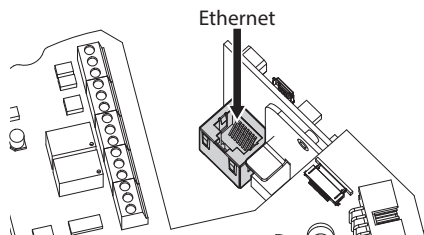

Будьте осторожны при установке. Момент затяжки: 4Нм.



Рис. 29



Рис. 30

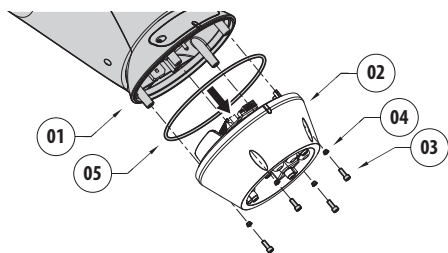

Существует единственное положение крепления между основанием и верхним корпусом. Выровняйте боковые выступы для правильного расположения.

8.7 Установка светодиодных (LED) осветителей

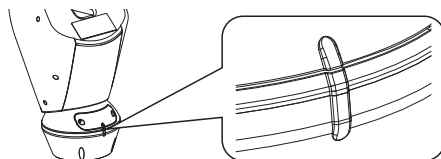
! Для правильного функционирования необходимо всегда устанавливать оба осветителя.

i На поворотном устройстве можно устанавливать только осветители VIDEOTEC.

8.7.1 Установка скобы

Расположите скобу (01) на нижней части футляра как показано на рисунке. Вставьте винты и шайбы (02) в отверстия (03) и затяните. Проверьте надежность крепления. Не используйте материалов, не входящих в набор.



Рис. 31

! Будьте осторожны при установке. Момент затяжки: 4Нм.

8.7.2 Установка осветителя на скобе

Расположите крепления осветителя (01) на креплениях скобы (02).

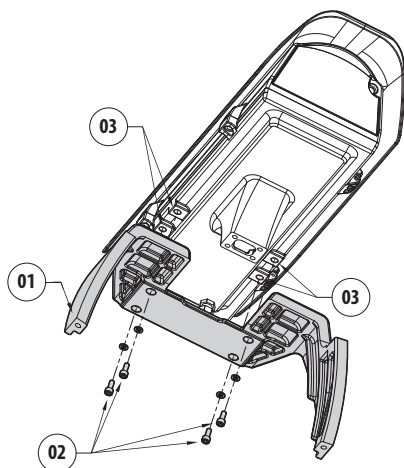

Рис. 32

Закрутите ранее снятые винты с шайбами.

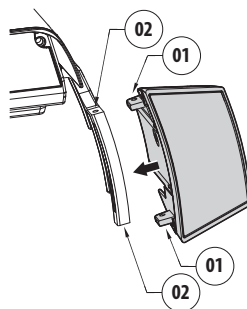

Рис. 33

! Будьте осторожны при установке. Момент затяжки: 6Нм.

8.8 Подключение светодиодных (LED) осветителей

Откройте футляр как описано (Рис. 7, страница 15).

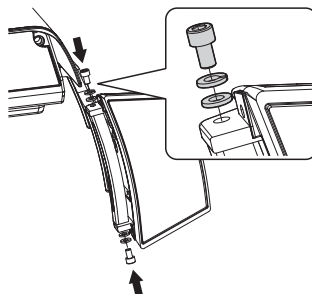
Введите кабели питания хотя бы на 25см через кабельные муфты.



Рис. 34



Чтобы не поставить под угрозу безопасность и функционирование узла, не оставляйте излишки кабеля снаружи.

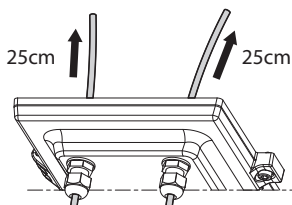
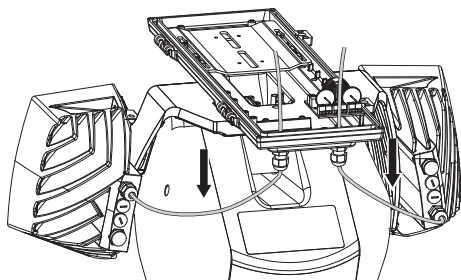

Подключите кабели, как показано на рисунке.



Рис. 35

ПОДКЛЮЧЕНИЕ СВЕТОДИОДНЫХ (LED) ОСВЕТИТЕЛЕЙ

Осветитель левый		Осветитель правый	
Ссылка на плату	Цвет кабеля	Ссылка на плату	Цвет кабеля
WH	белый	WH	белый
BK	Черный	BK	Черный
A1	Зеленый	A2	Зеленый
B1	Красный	B2	Красный

Таб. 8

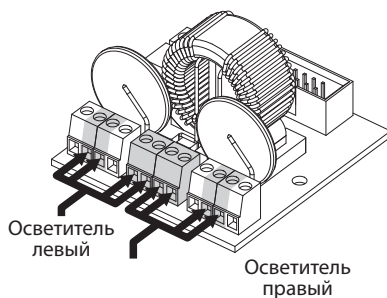
8.9 Пакетик с осушителем

Прикрепите пакетик с осушителем с помощью специального хомута.



Рис. 36



Рис. 37 Присутствует в версиях со светодиодными (LED) осветителями.

8.10 Установка светодиодных (LED) осветителей и режим синхронизации с телекамерой

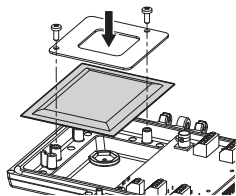
! После завершения регулировки левый осветитель (MASTER) синхронизирует и контролирует осветитель справа (SLAVE).

Сумеречный выключатель считывает окружающее освещение и контролирует включение и отключение осветителей, когда яркость достигает заданного пользователем уровня.

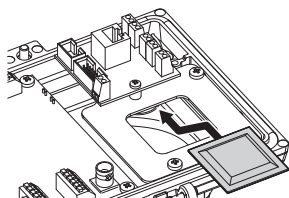
Когда светодиодные (LED) осветители активированы, телекамера переходит в ночной режим с помощью специальной команды ONVIF.

8.10.1 Описание светодиодного (LED) осветителя

! Для обеспечения правильного и безопасного функционирования осветителя не откручивать прозрачный винт датчика освещенности.

- **Сумеречный датчик:** Измеряет уровень яркости.
- **Кабель:** Питание и управление.
- **Регулятор порога включения:** Потенциометр позволяет регулировать уровень чувствительности для включения осветителя.
- **Регулятор мощности инфракрасных:** Потенциометр регулировать мощность осветителя.



Рис. 38

8.10.2 Синхронизация с внешним сумеречным выключателем

Для синхронизации осветителей и телекамеры с внешним сумеречным датчиком необходимо:

- Подключите сумеречный выключатель к клеммам: AL 1/AGND (8.4.3 Подключение входов сигналов тревоги, сумеречного выключателя и реле, страница 22).
- Отрегулировать левый осветитель (MASTER):
 - **Порог включения:** Установить значение на OFF (8.10.5 Регулировка порога включения светодиодных (LED) осветителей, страница 28).
 - **Мощность инфракрасных осветителей:** Установить значение в зависимости от потребностей (8.10.6 Регулировка мощности светодиодных (LED) осветителей, страница 28).
- Регулировка правого осветителя (SLAVE):
 - **Порог включения:** Установите значение на максимум (8.10.5 Регулировка порога включения светодиодных (LED) осветителей, страница 28).
 - **Мощность инфракрасных осветителей:** Установить значение на минимум (8.10.6 Регулировка мощности светодиодных (LED) осветителей, страница 28).

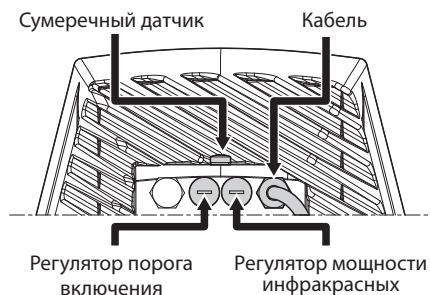
В строке Зонд IR (Sonda IR) выберите опцию Внешняя (Esterna) (10.1.13 Параметры Камеры, страница 38).

В плате I/O Цифровых установить значения следующим образом (10.1.11 Цифровые входы/выходы, страница 37):

- **ID сигнала тревоги:** 1
- **Вид:** ОБЫЧНО ОТКРЫТЫЙ
- **Действие:** IR_FILT

8.10.3 Синхронизируйте узел с LED осветителями

Для синхронизации LED осветителями и телекамеры с внешним сумеречным датчиком необходимо:

- Отрегулировать левый осветитель (MASTER):
 - **Порог включения:** Установить значение в зависимости от потребностей (8.10.5 Регулировка порога включения светодиодных (LED) осветителей, страница 28).
 - **Мощность инфракрасных осветителей:** Установить значение в зависимости от потребностей (8.10.6 Регулировка мощности светодиодных (LED) осветителей, страница 28).

- Регулировка правого осветителя (SLAVE):
 - **Порог включения:** Установите значение на максимум (8.10.5 Регулировка порога включения светодиодных (LED) осветителей, страница 28).
 - **Мощность инфракрасных осветителей:** Установить значение на минимум (8.10.6 Регулировка мощности светодиодных (LED) осветителей, страница 28).

В строке Параметры Камеры (Parametri Camera) выберите опцию Внутренняя (Interna) (10.1.13 Параметры Камеры, страница 38).

8.10.4 Ручная активация LED осветители

Если нужно активировать светодиодный (LED) осветитель, необходимо:

- Отрегулировать левый осветитель (MASTER):
 - **Порог включения:** Установить значение на OFF (8.10.5 Регулировка порога включения светодиодных (LED) осветителей, страница 28).
 - **Мощность инфракрасных осветителей:** Установить значение в зависимости от потребностей (8.10.6 Регулировка мощности светодиодных (LED) осветителей, страница 28).
- Регулировка правого осветителя (SLAVE):
 - **Порог включения:** Установите значение на максимум (8.10.5 Регулировка порога включения светодиодных (LED) осветителей, страница 28).
 - **Мощность инфракрасных осветителей:** Установить значение на минимум (8.10.6 Регулировка мощности светодиодных (LED) осветителей, страница 28).

8.10.5 Регулировка порога включения светодиодных (LED) осветителей

! Правый осветитель всегда должен быть отрегулирован на максимальную яркость.



Рис. 39

Осветитель представляет собой встроенный сумеречный датчик, обеспечивающий автоматическое включение и выключение при заданных условиях освещенности.

Регулировка сумеречного датчика выполнена на фабрике и настроена на заранее установленный уровень освещения, подходящего для большинства установок (около 50 люкс). Если нужно отрегулировать иным способом порог срабатывания, отвинтите пробку, установленную на задней поверхности осветителя и отрегулируйте с помощью отвертки.

Поворот триммера по часовой стрелке вызывает преждевременную коммутацию в ночной режим (переключение на более высокое значение освещенности). Поворот триммера против часовой стрелки вызывает запаздывание коммутации в ночной режим (переключение на более низкое значение освещенности).

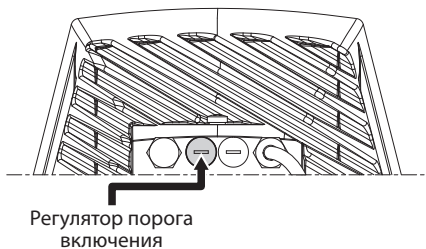

Рис. 40

Подождите условий освещенности, подходящих для включения осветителя. Медленно поворачивайте триммер до включения светодиодов, установленных на боку триммера. Как только превышает порог срабатывания (LED включенный), слегка поверните в обратном направлении.

! По завершении регулировок проверьте, чтобы заглушка была соответственно затянута, гарантируя герметичность изделия.

8.10.6 Регулировка мощности светодиодных (LED) осветителей

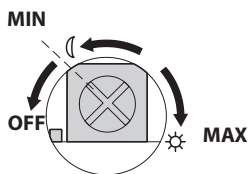
! Правый осветитель всегда должен быть отрегулирован на минимальную мощность.

i Осветитель регулируется на фабрике так, чтобы давать максимальную мощность. S'il ne fallait pas éclairer des sujets éloignés ou si l'image était surexposée à cause de la luminosité excessive, effectuer le réglage de la puissance pour l'abaisser et pour obtenir une économie énergétique.



Рис. 41

Отвинтите герметичную заглушку. Поверните триммер по часовой стрелке, чтобы увеличить мощность инфракрасного осветителя и против часовой стрелки, чтобы уменьшить.

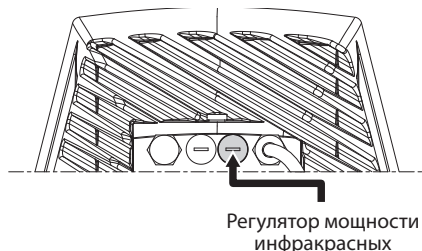

Рис. 42

! По завершении регулировок проверьте, чтобы заглушка была соответственно затянута, гарантируя герметичность изделия.

8.11 Конфигурация аппаратного обеспечения

i Конфигурация аппаратного обеспечения необходима только в случае, если есть желание активировать режим связи посредством последовательного телеуправления. (12.1 Изменяет режим связи (от протокола ONVIF до последовательного телеуправления), страница 42).

8.11.1 Открытие конфигурационной дверцы

Перед подачей питания на устройство, необходимо правильно его конфигурировать с помощью dip-переключателей, установленных на конфигурационной дверце. Откройте дверцу, отвинтив винты, как показано на рисунке.



Рис. 43

DIP-выключатели такие, как представлено на рисунке.

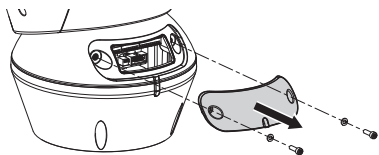

Рис. 44

i По завершении операций по установке и прокладке кабеля закройте устройство.

8.11.2 Конфигурация DIP1

i Рычажок переключателя в положении вверх представляет значение 1 (ON). Рычажок вниз - значение 0 (OFF).

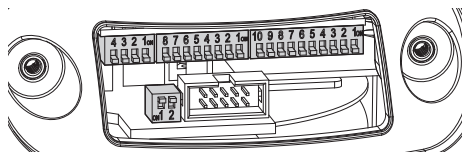
Переключатель 1 используется для обновления микропрограммы.



Рис. 45

КОНФИГУРАЦИЯ DIP1					
Описание	SW 4	SW 3	SW 2	SW 1	Baud rate
Регулировка скорости двоичной передачи	OFF	OFF	OFF	-	300 baud
	ON	OFF	OFF	-	600 baud
	OFF	ON	OFF	-	1200 baud
	ON	ON	OFF	-	2400 baud
	OFF	OFF	ON	-	4800 baud
	ON	OFF	ON	-	9600 baud
	OFF	ON	ON	-	19200 baud
	ON	ON	ON	-	38400 baud
Обновления прошивки	-	-	-	ON	Программирование активировано
	-	-	-	OFF	Программирование деактивировано

Таб. 9

8.11.3 Конфигурация DIP2

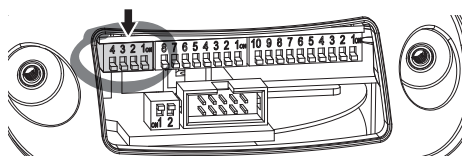
i Рычажок переключателя в положении вверх представляет значение 1 (ON). Рычажок вниз - значение 0 (OFF).

Наводку можно контролировать через различные протоколы.



Рис. 46

КОНФИГУРАЦИЯ DIP2								
Протокол	SW 8	SW 7	SW 6	SW 5	SW 4	SW 3	SW 2	SW 1
PTZ Manager ¹	OFF	OFF	OFF	OFF	OFF	OFF	OFF	OFF
MACRO (VIDEOTEC)	OFF	OFF	OFF	OFF	OFF	ON	ON	ON
PANASONIC	OFF	OFF	OFF	ON	OFF	ON	OFF	OFF
PELCO D	OFF	OFF	OFF	OFF	ON	OFF	OFF	ON
AMERICAN DYNAMICS	OFF	OFF	OFF	OFF	ON	ON	ON	OFF
VISTA	OFF	OFF	OFF	ON	OFF	OFF	ON	ON

Таб. 10 ¹ Конфигурация: MACRO (VIDEOTEC), 115200 baud, RS-232, Адрес 1. Эта опция не требует установки DIP-switch (DIP1, DIP3).

Таб. 11

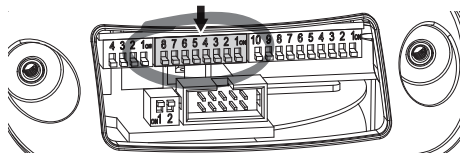
8.11.4 Конфигурация DIP3

i Рычажок переключателя в положении вверх представляет значение 1 (ON). Рычажок вниз - значение 0 (OFF).



Рис. 47

8.11.4.1 Установка адреса

Выключатели от 1 до 8 используются для конфигурации адреса блока (от 1 до 255).

Выбор адреса происходит в зависимости от двоичного кода (А Приложение - Таблица адресов, страница 50).

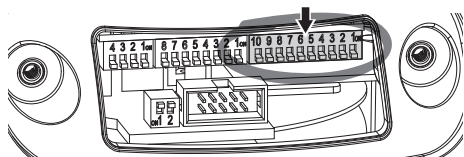
8.11.4.2 Конфигурация серийные линии связи

Устройство предусматривает последовательную линию связи RS-485 и последовательную линию RS-232.

Выключатели 10 и 9 используются для конфигурации последовательных линий.

КОНФИГУРАЦИЯ DIP3		
Описание	SW 10	SW 9
Однонаправленная связь на линии RS-485-1. Двухнаправленная связь на линии RS-232.	OFF	OFF
Двухнаправленная связь, полудуплексная связь (half-duplex) на линии RS-485-1.	ON	ON

Таб. 12

8.11.5 Конфигурация DIP4

i Настройка этого DIP выполняется в обратном порядке, чем ранее выполненные. Рычажок переключателя в положении вверх представляет значение 0 (OFF). Рычажок вниз - значение 1 (ON).

В плате имеются два переключателя, использованные для конфигурации терминала (120 Ohm) серийных линий.



Рис. 48

Каждое блок, которое находится в конце линии, должно использоваться со специальным переключателем во избежание создания отражений и деформаций сигнала.

КОНФИГУРАЦИЯ DIP4			
Серийная линия	SW 2	SW 1	Описание
Factory default	-	ON	Включена
	-	OFF	Отключается
Линия RS-485-1	ON	-	Завершено
	OFF	-	Не завершенная

Таб. 13

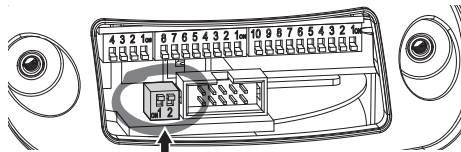
Для приведения наводки к заводским настройкам по умолчанию обратитесь к соответствующей главе (10.1.15 Factory Default, страница 39).

9 Включение



Проверить, что прибор, и другие компоненты установки закрыты таким образом, чтобы предотвратить контакт с компонентами под напряжением.



Во время нормального функционирования поверхность осветителя может нагреваться до высоких температур. Избегайте прямого контакта и расположите аппаратуру в месте, недоступном для неуполномоченного персонала. Для выполнение любых работ по техобслуживанию выключите осветительное устройство и оставьте остывать не менее 10 минут.



Не находитесь рядом с прибором, если на него подается питание. Воздействуйте на устройство только при отключенном питании.



Проверьте, чтобы все компоненты были закреплены хорошо и надежно.



Процедура автоматического предварительного подогрева (De-Ice) может быть активирована всегда, когда устройство включается при температуре окружающей среды ниже 0°C. Процедура служит для обеспечения правильного функционирования прибора даже при низких температурах. Долгота меняется от 60 до 105 минут в соответствии с условиями.

Чтобы включить прибор, подключить электропитание.

Чтобы выключить прибор, следует его обесточить.

10 Конфигурация

10.1 Интерфейс веб

i При первом включении присвойте адрес, отличный от 192.168.0.100.

i Поддерживаемые браузеры: Microsoft Internet Explorer, Google Chrome, Mozilla Firefox.

i MAC-адрес приводится на этикетке, наклеенной на плате ЦП.



Рис. 49

Первая операция, необходимая для конфигурации поворотного устройства, заключается в подключении к его веб-интерфейсу.

В заранее установленных настройках поворотное устройство конфигурировано для автономного приобретения адреса с помощью протокола DHCP и можно обнаружить устройство с помощью протокола ONVIF, профиль S.

Если отсутствует какой-либо сервер DHCP, поворотное устройство автоматически выполнит конфигурацию с адресом 192.168.0.100.

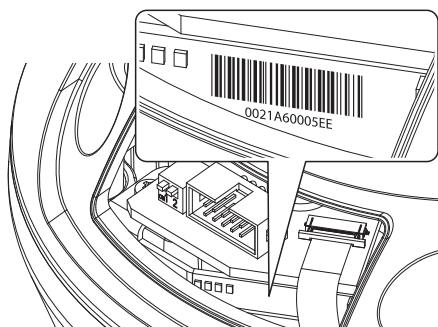
Если нет в наличии VMS с функционированием Auto Discovery с помощью ONVIF, приобретенный адрес можно прочитать в списках сервера DHCP.

Для получения доступа к поворотному устройству достаточно подключиться к браузеру по адресу: `http://indirizzo_ip` и выполнить логин с помощью заранее установленных данных учетной записи:

- **Имя пользователя:** admin
- **Пароль:** admin

10.1.1 Первый доступ

Для правильного функционирования поворотное устройство должно быть конфигурировано в зависимости от установленной телекамеры.

Возможными параметрами являются:

- Протокол IP используется для поддержки связи с телекамерой.
- Тип установленных линз (моторизованная, неподвижная или интегрированная).
- Реквизиты, необходимые для подключения к камере IP (имя пользователя и пароль установленной телекамеры).



Рис. 50

⚠ Камера IP, установленная на поворотном устройстве, должна быть конфигурирована для получения IP-адреса с помощью DHCP.

10.1.2 Home

Если логин выполнен успешно, появится интерфейс управления поворотным устройством.

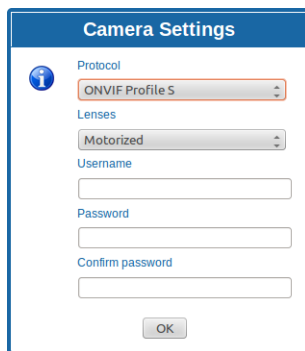

Рис. 51

10.1.3 Проверки пользователя

Для контроля поворотного устройства через браузер необходимо выбрать строку User Control. Откроется новое окно с виртуальной клавиатурой для передачи команд.



Рис. 52

На виртуальной клавиатуре размещены следующие устройства управления:

- **Переключатель скорости:** Позволяет выбрать скорость движений поворотного устройства.

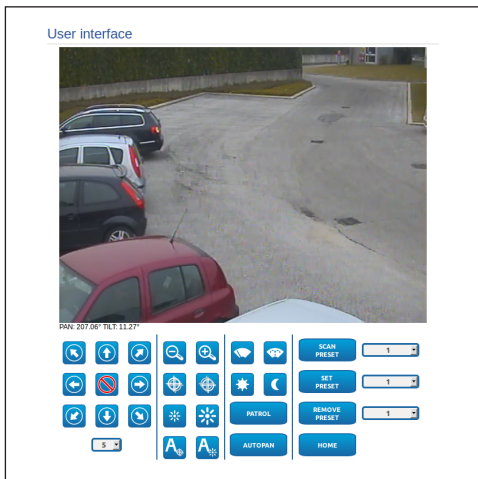

Рис. 53

- **Zoom wide/Zoom tele**



Рис. 54

- **Focus far/Focus near/Auto focus**



Рис. 55

- **Iris close/Iris open/Auto iris**



Рис. 56

- **Wiper/Washer**



Рис. 57

- **Day:** Активирует фильтр IR камеры. Если присутствуют, выключает светодиодные (LED) осветители.



Рис. 58

- **Night:** Деактивирует фильтр IR камеры. Если присутствуют, включает светодиодные (LED) осветители.



Рис. 59

10.1.4 Параметры Устройства

В строке меню Device Parameters можно присвоить название поворотному устройству и отобразить иную дополнительную информацию.

Device Parameters

Device Name	UlisseNet.cam
Product Code	LPT25VJANO0E
Serial Number	113121290001
MAC Address	00:21:A6:00:07:D8
Product ID	2
Firmware Version: CPU Board	2.0
Firmware Version: NET Board	6.0.0
Firmware Version: MPF Board	6.0.0
Hardware Revision	0
Major Revision	0
Minor Revision	0
Housing Type	0

Рис. 60

10.1.5 Статистика Устройства

В строке меню Device Statistics приведены, только в консультативных целях, все статистические данные, собранные во время функционирования поворотного устройства.

Device Statistics

Pan degrees	3364
Tilt degrees	1442
Power up	133
Working hours	26
Housing max temperature (°C)	40
Housing min temperature (°C)	65454
Pan board max temperature (°C)	50
Pan board min temperature (°C)	22
CPU board max temperature (°C)	43
CPU board min temperature (°C)	20
Net board max temperature (°C)	39
Net board min temperature (°C)	19
IR Light ON hours	0

Рис. 61

10.1.6 Конфигурация сети

В строке меню Network Configuration можно изменять сетевые настройки поворотного устройства. Можно решить способ присвоения адреса устройству: статически, динамически с помощью DHCP или путем автоматического генерирования. Устройство поддерживает 4 версию интернет-протокола (IP).

! Благодаря автоматически генерированному адресу устройство автоматически присвоит себе адрес в диапазоне 9.254.0.0/16.

На этой же странице можно конфигурировать 2 DNS и решить, какие механизмы должны быть активированы для автоматической идентификации устройств в локальной сети.

Network Configuration

IP Version	IPv4
Address Type	STATIC
IP Address (IPv4)	192.168.103.121
Subnet Mask (IPv4)	255.255.255.0
Gateway (IPv4)	192.168.103.1
DNS auto discovery	DISABLED
Primary DNS	9.9.4.4
Secondary DNS	8.8.8.8
Date & Time	2013-05-27 14:41:53 UTC
NTP Server	DISABLED
PC Sync	ENABLED
UPNP	ENABLED
Zerocast	ENABLED
Multicast discovery	ENABLED
WS discovery	ENABLED

Рис. 62

Можно также решить должно ли устройству быть синхронизированным с внешним сервером NTP (Network Time Protocol).

- **NTP -> ОТКЛЮЧЕННЫЙ:** Выберите данную опцию, если желаете синхронизировать дату и время устройства.
- **NTP -> DHCP:** Выберите данную опцию, если желаете синхронизировать дату и время устройства с датой и временем сервера NTP (Network Time Protocol), указанного сервером DHCP.
- **NTP -> СТАТИЧЕСКИЙ:** Выберите данную опцию, если желаете синхронизировать дату и время устройства с датой и временем сервера NTP, указанного статическим адресом.

i Для правильного функционирования устройства необходимо синхронизировать поворотное устройство с программным обеспечением VMS, используя сервер NTP.

i Для правильного функционирования устройства необходимо синхронизировать камеру с поворотным устройством. В целях получения такой синхронизации выберите, на веб-странице камеры, опцию NTP из DHCP или укажите адрес 192.0.0.1 как статический адрес сервера NTP.

10.1.7 Конфигурация пользователей

В строке меню User Configuration можно управлять пользователями, имеющими доступ к поворотному устройству. Пользователи категории Administrator могут получать доступ к конфигурации устройства. Такие пользователи как Operator, User и Anonymous имеют ограниченный доступ к страницам управления.



Рис. 63

i Устройство могут конфигурировать только пользователи со статусом администратора.

10.1.8 Параметры Движения

В строке меню Movement Parameters можно контролировать через сеть все параметры поворотного устройства.

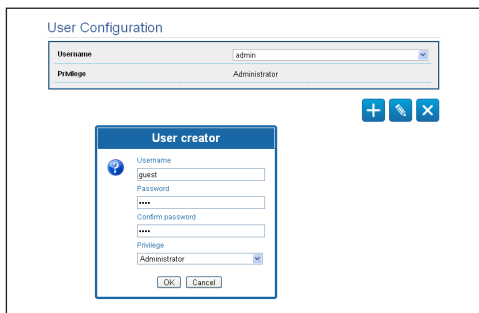
- **Offset Pan:** Наводка имеет положение на 0°, определённое механически. Функция Offset Pan позволяет определить путём программного обеспечения положение, отличающееся от 0°.
- **Максимальная Скорость:** Устанавливает ручную максимальную скорость.
- **Скорость С Зумом:** Включает опцию Скорость с зумом. Этот параметр, если он включён, автоматически снижает скорость Pan и Tilt в зависимости от коэффициента фокусного расстояния.
- **Фактор Tilt:** Устанавливает фактор снижения ручной скорости оси tilt.
- **Ограничения Pan:** Подготавливает ограничения Pan.
- **Начало Pan:** Устанавливает начальное ограничение Pan.
- **Окончание Pan:** Устанавливает конечное ограничение Pan.
- **Начало Tilt:** Устанавливает начальное ограничение Tilt.
- **Окончание Tilt:** Устанавливает конечное ограничение Tilt.



Рис. 64

10.1.8.1 Autopan

В подразделе Autopan можно указать предварительные настройки начала и завершения автопанорамирования.

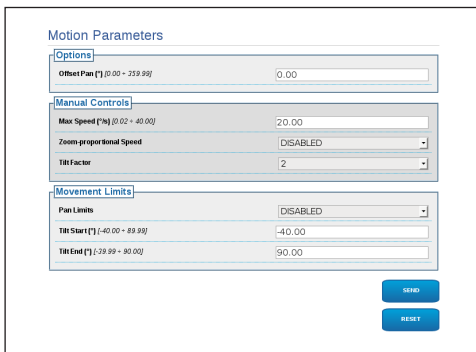

Рис. 65

10.1.8.2 Patrol

В подразделе Patrol можно указать предварительные настройки начала и завершения патрулирования. Кроме того, можно указать как должно происходить сканирование предварительных установок случайно или нет.

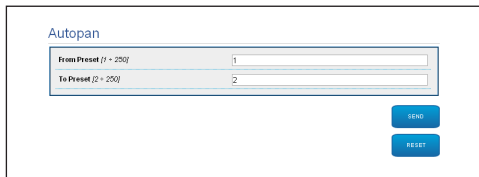

Рис. 66

10.1.8.3 Вызов Движений

В подразделе Motion Recall можно указать интервал времени отсутствия активности, по окончании которого поворотное устройство выполнит одно из следующих действий: возврат в исходное положение, запуск автопанорамирования или патрулирование.

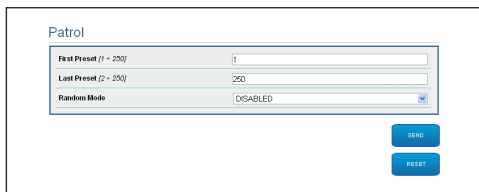

Рис. 67

10.1.9 Параметры Предварительных настроек (Preset)

В строке меню Preset Parameters можно конфигурировать некоторые параметры, касающиеся предварительных настроек.:

- **Скорость Сканирования:** Скорость в градусах в секунду, с которой достигается предварительная настройка по четкому указанию оператора.
- **Тип рампы:** Позволяет выбрать ускорения поворотного устройства.
- **Скорость движений (по умолчанию):** Скорость, используемая в операциях autopan и patrol.
- **Установить скорость по умолчанию:** Скорость по умолчанию устанавливается также как скорость развертывания для всех предварительных настроек.
- **Пауза По Умолчанию:** Время, в секундах, пребывания по умолчанию в каждой предварительной настройке.
- **Установить паузу по умолчанию:** Пауза по умолчанию устанавливается для всех предварительных настроек (preset).

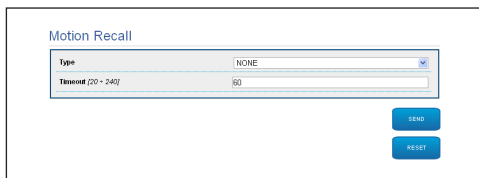

Рис. 68

10.1.10 Параметры Предварительных настроек (Дополнительно)

В разделе Preset Parameters (Advanced) можно персонализировать значения скорости и паузы для каждой предварительной настройки, а также подключать / отключать сами предварительные настройки.

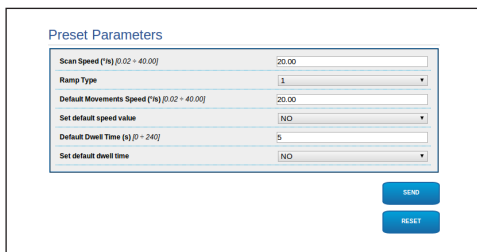

Рис. 69

10.1.11 Цифровые входы/выходы

В плате цифровых входов/выходов можно конфигурировать цифровые каналы, присутствующие в поворотном устройстве. Следует краткое описание параметров, которые можно конфигурировать, для каждого цифрового входа.

- **ID сигнала тревоги:** Поле, используемое для выбора нужного цифрового входа.
- **Вид:** Указывает режим по умолчанию цифрового входа. Может быть установлено на Обычно открытый или Обычно закрытый
- **Действие:** К каждому входу может быть присоединено какое-либо действие. Действие активируется в момент, когда контакт переходит в состояние, отличное от стандартного. Ниже перечислены возможные действия:
 - **NONE:** Никаких действий.
 - **SCAN:** Располагает поворотное устройство соответственно выбранным предварительным настройкам preset.
 - **PATROL:** Активирует PATROL (патрулирование).
 - **AUTO-PAN:** Активирует AUTOPAN (автопанорамирование).
 - **WIPER:** Активирует стеклоочиститель (Wiper).
 - **WASHER:** Активирует последовательность мытья стекла.
 - **РЕЛЕ 1:** Активирует реле 1
 - **РЕЛЕ 2:** Активирует реле 2
 - **IR FILT:** Деактивирует фильтр IR камеры. Если присутствуют, включает светодиодные (LED) осветители.

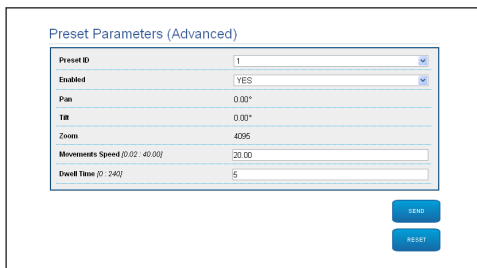
Для проверки правильного функционирования сигналов тревог на странице веб присутствует кружочек. В нормальных условиях цвет кружочка зеленый, а в условиях обнаружения сигнала тревоги - красный.



Рис. 70

10.1.12 Washer

Насос для мытья поворотного устройства конфигурирован в плате Washer, где к операции мытья можно присоединить предварительную настройку, задать длительность мытья стекла, указать задержку активации и отключения стеклоочистителя.

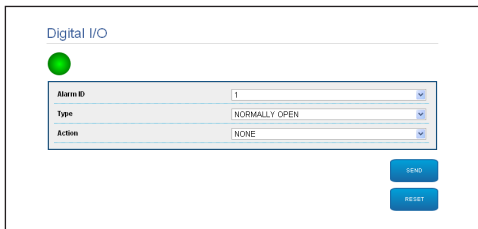

Рис. 71

10.1.13 Параметры Камеры

Параметры камеры IP, заданные при первом запуске, можно изменить в строке меню Camera Parameters. В строке меню Camera Parameters можно также указать zoom изображения и точность положения вариобъектива. В данном разделе можно также визуализировать данные, касающиеся различных профилей ONVIF, экспортированных камерой.

В строке меню Lenses можно выбрать одну из следующих опций:

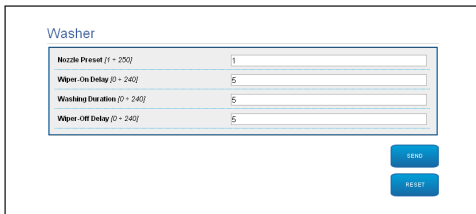
- **Моторизованные:** Контроль с поворотного устройства
- **Интегрированные:** Контроль с телекамеры
- **Фиксированные:** Не контролируются.

В случае моторизованных линз можно установить соединение (с общим проводом или при инверсионной полярности) и полярность вращения Zoom, Focus и Iris.



Рис. 72

Для изменения установок телекамеры выберите кнопку VTunnel (10.1.14 Инструменты, страница 38).

10.1.14 Инструменты

В строке меню Tools можно перенастраивать стандартные значения всей конфигурации поворотного устройства или только некоторых специальных секций.

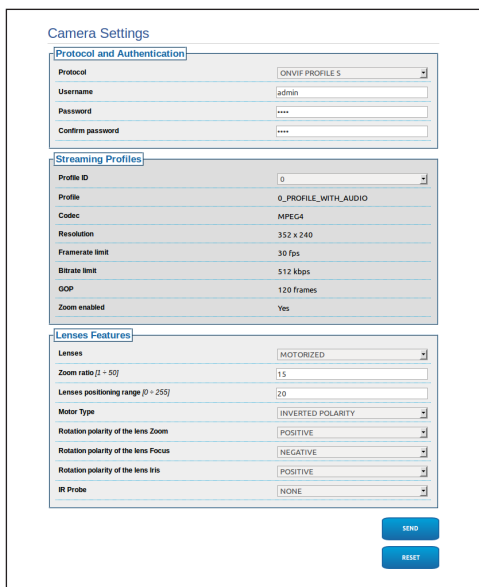
Кроме того, в данном разделе можно:

- Обновите микропрограмму устройства.
- Снова включите поворотное устройство.
- Загрузите приложение VTunnel, для того, чтобы активировать связь с камерой IP, необходимо зайти на страницу веб камеры.



Рис. 73

10.1.15 Factory Default

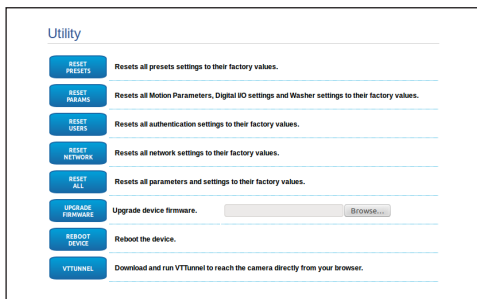

Если пароль уже не доступен, можно восстановить заводские установки, также с помощью кнопки Reset, установленной внутри основания.

Для восстановления настроек фабрики касающихся сети, во время доступа пользователей и конфигурации камеры выполните процедуру:

- Подать питание на узел.
- Откройте дверцу DIP-переключателей.
- Определить местоположение DIP-switch 4 (01). Привести switch (переключатель) в нижнее положение, значение 1 (ON) (Включено).
- Подождите временного выключения светодиодов (02).
- Привести switch (переключатель) в верхнее положение, значение 0 (OFF) (Отключено).
- Закройте дверцу.



Рис. 74

10.2 VTTunnel



Приложение функционирует только с Java™. Если программное обеспечение Java™ не установлено заранее, загрузите последнюю версию с сайта www.java.com.

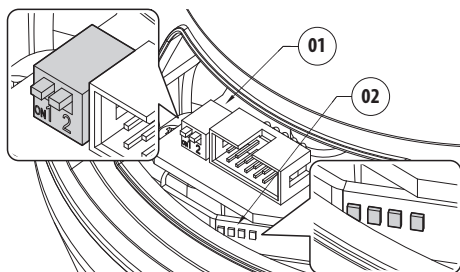

Приложение может подсоединяться только к первому активному сетевому интерфейсу. Оставьте подключенным только кабель, подключенный к поворотному устройству.



Выполнение приложения является прерогативой администратора компьютера. На мониторе может появиться сообщение: You have to execute Javaw as administrator. В данном случае необходимо изменить особенности запуска файла avaw.exe из папки установки Java.

Чтобы подключиться к интерфейсу телекамеры, необходимо использовать приложение VTTunnel, запускающийся со строки меню Tools.

При запуске приложения будет показан список устройств, подключенных в сети. Для подключения к камере необходимо выбрать нужное поворотное устройство и нажать клавишу Connect.

Как только будет установлена связь, страница веб-телекамеры IP будет доступна по адресу 192.0.0.64 .

По завершении операций на телекамере можно выключить соединение, нажав клавишу Disconnect. Можно подключиться к только одной телекамере за один раз, поэтому необходимо отключиться от поворотного устройства перед тем, как начать работу с другим устройством позиционирования.



Рис. 75



Если в процессе настройки телекамеры изменяются параметры потока видео, необходимо настроить соответствующим образом наводку.

11 Аксессуары

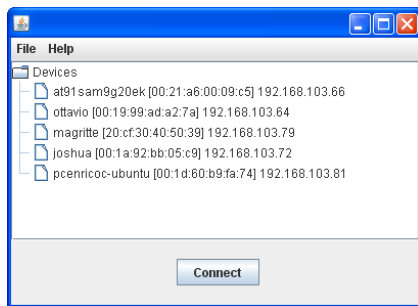

Для дополнительной информации по конфигурации и использованию обращаться к руководству по эксплуатации соответствующего оборудования.

11.1 Установка мойки

Поворотное устройство может быть укомплектовано внешним насосом для очистки стекла.

Когда отправляется команда, поворотное устройство располагается окном перед форсункой (10.1.3 Проверки пользователя, страница 33). Активируются насос и стеклоочиститель на определенный период времени. В конце процедуры поворотное устройство вернется в начальное положение.



Рис. 76

11.1.1 Подключение мощного оборудования



ПРЕДУПРЕЖДЕНИЕ! Установка типа TNV-1. Не подключайте к системам SELV.

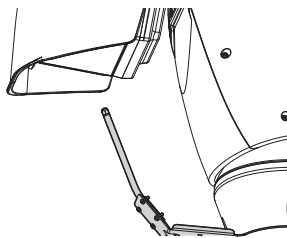

ПРЕДУПРЕЖДЕНИЕ! Для снижения опасности пожара пользуйтесь исключительно кабелями, имеющими сертификат UL Listed или CSA, имеющими размеры не менее $0,13\text{mm}^2$ (26AWG).



Все сигнальные кабели должны быть сгруппированы под одним хомутиком.

ПОДКЛЮЧЕНИЕ МОЩНОГО ОБОРУДОВАНИЯ	
Клеммы	Описание
O1-C1	Чистый контакт для включения установки мойки.

Таб. 14



Рис. 77

11.2 Настенное крепление

Настенный кронштейн с внутренним кабельным каналом изготовлен из алюминия и окрашен порошковой краской.

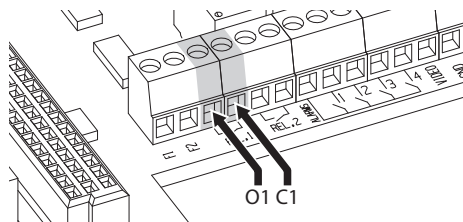

Рис. 78

11.3 Кронштейн для поручней

Кронштейн для монтажа на поручни с внутренним прохождением кабелей.

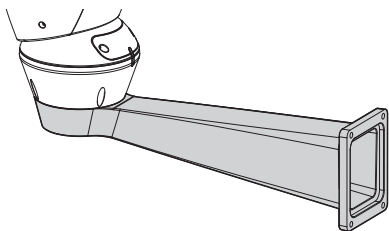

Рис. 79

11.4 Блок питания с функцией контроля осветителей

Герметичная коробка с блоком питания и контроля осветителей.

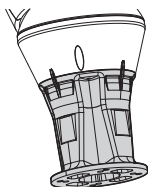

Рис. 80 Версия стандартной коробки.



Рис. 81 Сертифицированный вариант корпуса UL.

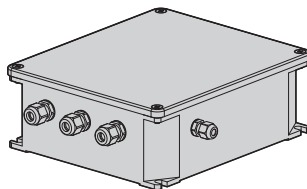

За дополнительной информацией обратитесь к соответствующей главе (8.4.3 Подключение входов сигналов тревоги, сумеречного выключателя и реле, страница 22).

12 Инструкции по исключительному функционированию

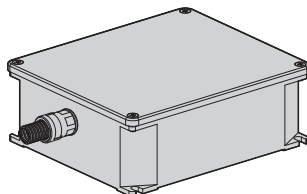
12.1 Изменяет режим связи (от протокола ONVIF до последовательного телеуправления)

Поворотное устройство изначально конфигурировано для поддержки связи с помощью протокола ONVIF.

12.1.1 Процедура изменения режима связи

Выключите поворотное устройство.

Настройте двухрядные (dip-) переключатели (8.11 Конфигурация аппаратного обеспечения, страница 29). Выполнить процедуру, указанную ниже:

Baud rate: 38400 (ON ON ON OFF)

Протокол: MACRO (OFF OFF OFF OFF OFF ON ON ON)

Последовательная связь и адрес телеуправления: RS-485 half-duplex, адрес 1 (ON ON OFF OFF OFF OFF OFF ON)

Включите поворотное устройство.

В браузере наберите адрес <indirizzo_ip>/cgi-bin/pc.cgi.



Рис. 82

Измените код изделия: буква N заменяется Y. Пример: От UPT25VUAN00E до UPT25VUAY00E.

Нажмите на Отправить (Invia). Подтвердите перезапуск устройства.

В браузере наберите адрес <indirizzo_ip>/cgi-bin/pc.cgi, чтобы проверить, что код изделия изменен. В случае проблем повторите процедуру сначала.

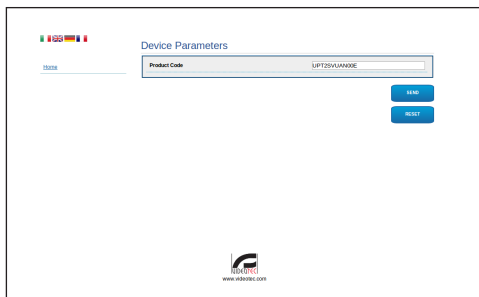
Выключите поворотное устройство.

Приведите в положение OFF dip-переключатели, показанные на рисунке.



Рис. 83

Конфигурируйте последовательную связь поворотного устройства как требует телекамера. Действуйте на dip-переключатель последовательной связи. (8.11 Конфигурация аппаратного обеспечения, страница 29).

Подключите последовательный порт телекамеры к разъему.

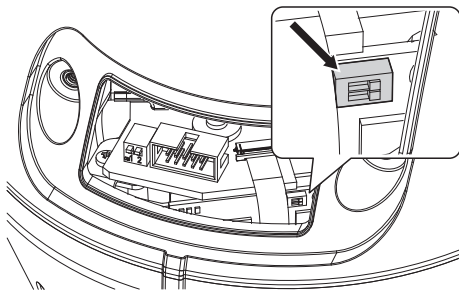

Рис. 84 Серый: RS-485 +. Розовый: RS-485 -.

Подключите питание телекамеры.

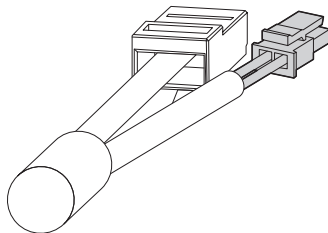

Рис. 85

Включите поворотное устройство.

Теперь поворотное устройство конфигурировано для поддержки связи с помощью последовательного телеуправления (RS-485).

13 Техобслуживание

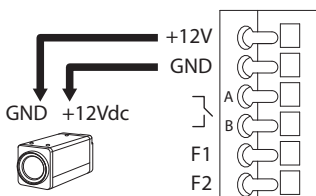

Техобслуживание должен выполнить только персонал с квалификацией работы на электрических контурах.

13.1 Замена предохранители



Всегда выполнять техобслуживание при отсутствии питания и с открытым разъединяющим устройством.

В случае необходимости заменить предохранитель показано на рисунке (8.3 Описание платы разъемов, страница 19).

ЗАМЕНА ПРЕДОХРАНИТЕЛИ		
Напряжение	Плавкий предохранитель F1	Плавкий предохранитель F2
24Vac, 50/60Hz	F 6.3A L 250V 5x20	T 8A H 250V 5x20
120Vac, 50/60Hz	F 6.3A L 250V 5x20	T 4A H 250V 5x20
230Vac, 50/60Hz	F 6.3A L 250V 5x20	T 2A H 250V 5x20

Таб. 15

14 Уборка

14.1 Очистка стекла и пластмассовых частей



Избегать применение этилового спирта, растворителей, гидрированных углеводородов, сильных кислот и щелочей. Использование названных продуктов наносит непоправимый вред обрабатываемой поверхности.

Для очистки линз очков рекомендуется пользоваться мягкой тканью с раствором нейтрального мыла или специальных чистящих средств в воде.

14.2 Очистка стеклянного окошка с содержанием германия.



Чистить окно, обращая внимание на то, чтобы не поцарапать внешнюю поверхность, обработанную графитовым покрытием. При повреждении этой поверхности, существует риск негативно повлиять на инфракрасную прозрачность поверхности.

Очистка должна быть выполнена нейтральным моющим средством, разбавленным водой.

15 Вывоз в отходы



Этот символ и система утилизации имеют значение только в странах ЕС и не находят применения в других странах мира.

Ваше изделие было изготовлено из материалов и компонентов высокого качества, могущих быть повторно использованными или утилизированными.

Электрические и электронные материалы, на которых имеется указанный символ, в конце срока службы должны выбрасываться отдельно от бытовых отходов.

Просим вывезти это устройство в Центр сбора или на экологическую станцию.

В Европейском Сообществе существуют системы дифференцированного сбора мусора для электронных и электрических изделий.

16 Устранение неисправностей

Запросить операцию квалифицированного персонала, поскольку:

- Узел повреждён вследствие падения;
- Эксплуатационные характеристики узла получили явное ухудшение;
- Устройство не работает должным образом, даже если вы выполнили все указания, приведенные в настоящем руководстве.

ПРОБЛЕМА	Устройство не включается.
ПРИЧИНА	<i>Ошибочная кабельная проводка, поломка плавких предохранителей.</i>
РЕШЕНИЕ	Проверьте правильность выполнения соединений. Проверьте сохранность плавких предохранителей и, в случае неполадки, замените на указанные.

ПРОБЛЕМА	В особых условиях увеличения существуют помехи от чехла или навеса полученному изображению (только для версий с моторизованным объективом).
ПРИЧИНА	<i>Видеокамера или объектив слишком отошли назад по отношению к окну.</i>
РЕШЕНИЕ	Отрегулировать положение видеокамеры и объектива.

ПРОБЛЕМА	Невозможно подключиться к телекамере.
ПРИЧИНА	<i>Неправильное подключение телекамеры.</i>
РЕШЕНИЕ	Проверьте подключения телекамеры.

ПРОБЛЕМА	Во время включения поворотное устройство остается заблокированным.
ПРИЧИНА	<i>Температура окружающей среды очень низкая.</i>
РЕШЕНИЕ	Подождите окончания процедуры предварительного нагрева.

ПРОБЛЕМА	Невозможно контролировать поворотное устройство.
ПРИЧИНА	<i>Неправильная конфигурация линии связи</i>
РЕШЕНИЕ	Проверьте конфигурацию двухрядных переключателей (8.11 Конфигурация аппаратного обеспечения, страница 29).

17 Технические параметры

17.1 Общее

Корпус из алюминия и ударопрочного пластика
Эпоксиполиэстеровое порошковое покрытие, цвет RAL9002
Верхнее крепление
Передача усилия через зубчатый ремень
Токосъёмное контактное кольцо
Электронные ограничители поворота
Простая установка и замена благодаря съёмным разъёмам
Отсутствие люфта
Инкрементный датчик положения, который гарантирует верное положение платформы в любых погодных условиях.
Встроенная щетка очиститель
Установка протоколов телеметрии происходит при помощи переключателей

17.2 Механика

Кабельная муфта: 3xM16
Горизонтальное вращение: продолж.
Вертикальное вращение: от +90° до-40°
Скорость по горизонтали (изменчивый): от 0.02°/с до 100°/с (от 0.02°/с до 40°/с, со со прожекторы со LED)
Скорость вертикального вращения (изменчивый): от 0.02°/с до 50°/с (от 0.02°/с до 30°/с,со со прожекторы со LED)
Полезные внутренние размеры: См. чертежи
Размеры стеклянного окна (ШxВ): 124x112mm
Погрешность препозиций: 0.02°
Вес устройства: 16.8kg (17.8kg, с кронштейном для светодиодных (LED) осветителей)

17.3 Электрические характеристики

Подходит для использования с сетевыми телекамерами

Питание/Потребление тока:

- 230Vac, 0.4A, 50/60Hz
- 24Vac, 4A (8A со со прожекторы со LED), 50/60Hz
- 120Vac, 0.8A, 50/60Hz

Потребляемая мощность:

- 100W
- 150-190W max со со прожекторы со LED в 24Vac
- 28.5W, поворотное устройство остановлено, нагревание выключено

Питание телекамер: 12Vdc (800mA)

4 тревожных входа самозапитываемых

2 сухих контакта: 30Vdc max о30Vac, @ 1A

17.4 Сообщения

Подключение Ethernet: IEEE 802.3 100Base-Tx

17.5 Протоколы

ONVIF, Профиль S

17.6 Среда

Внутренняя/Наружная установка

Рабочая температура

- С нагревателем: -20°C/+60°C
- С усовершенствованным нагреванием: -30°C/+60°C

Устойчивость к импульсам: до 2kV линия в линию, до 4kV линия в землю (Class 4)

17.7 Сертификация

Электрическая безопасность (CE): EN60950-1, IEC60950-1

Электромагнитная совместимость (CE): EN50130-4, EN610000-6-4, EN55022 (Класс A), FCC Part 15 (Класс A)

Установка снаружи (CE): EN60950-22, IEC60950-22

Фотобиологическая безопасность (CE): EN62471 прожекторы со LED)

Степень защиты IP корпуса: EN60529, IP66

Защита от соленого тумана: EN50130-5, EN60068-2-52

Сертификация UL: cULus Listed (TYPE 4X)

Сертификат EAC

18 Технические чертежи

i Размеры в чертежах выражены в миллиметрах.



Рис. 86 ULISSE PLUS NETCAM.



Рис. 87 ULISSE PLUS NETCAM, версия с приспособлениями для установки светодиодных (LED) осветителей.

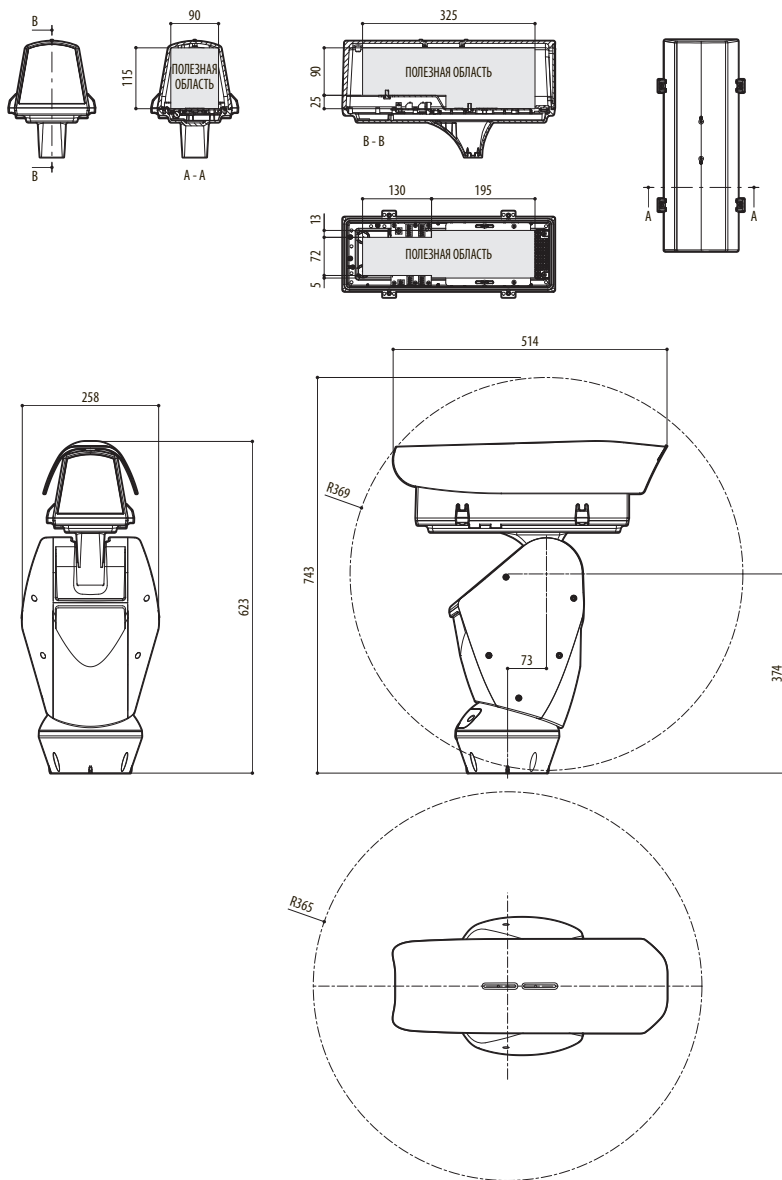

Рис. 88 ULISSE PLUS NETCAM, версия для тепловых камер.

А Приложение - Таблица адресов

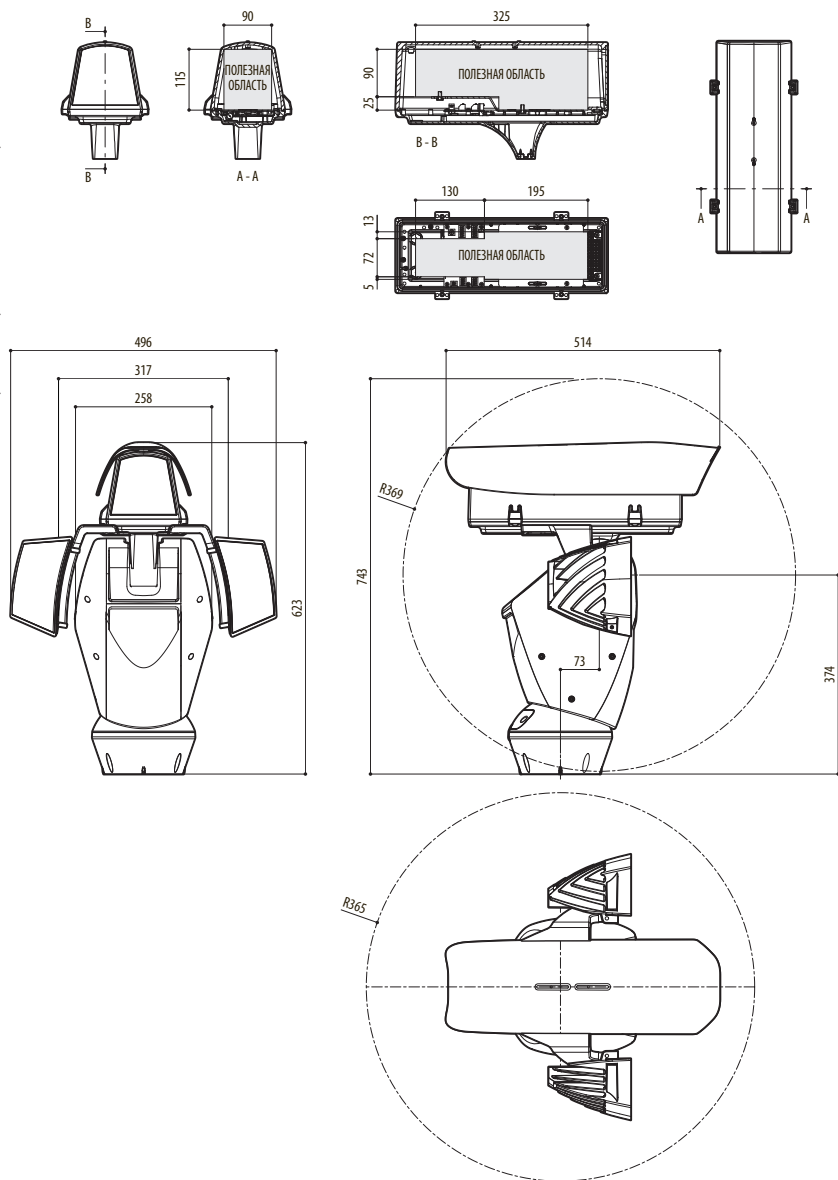

Рычажок переключателя в положении вверх представляет значение 1 (ON). Рычажок вниз - значение 0 (OFF).

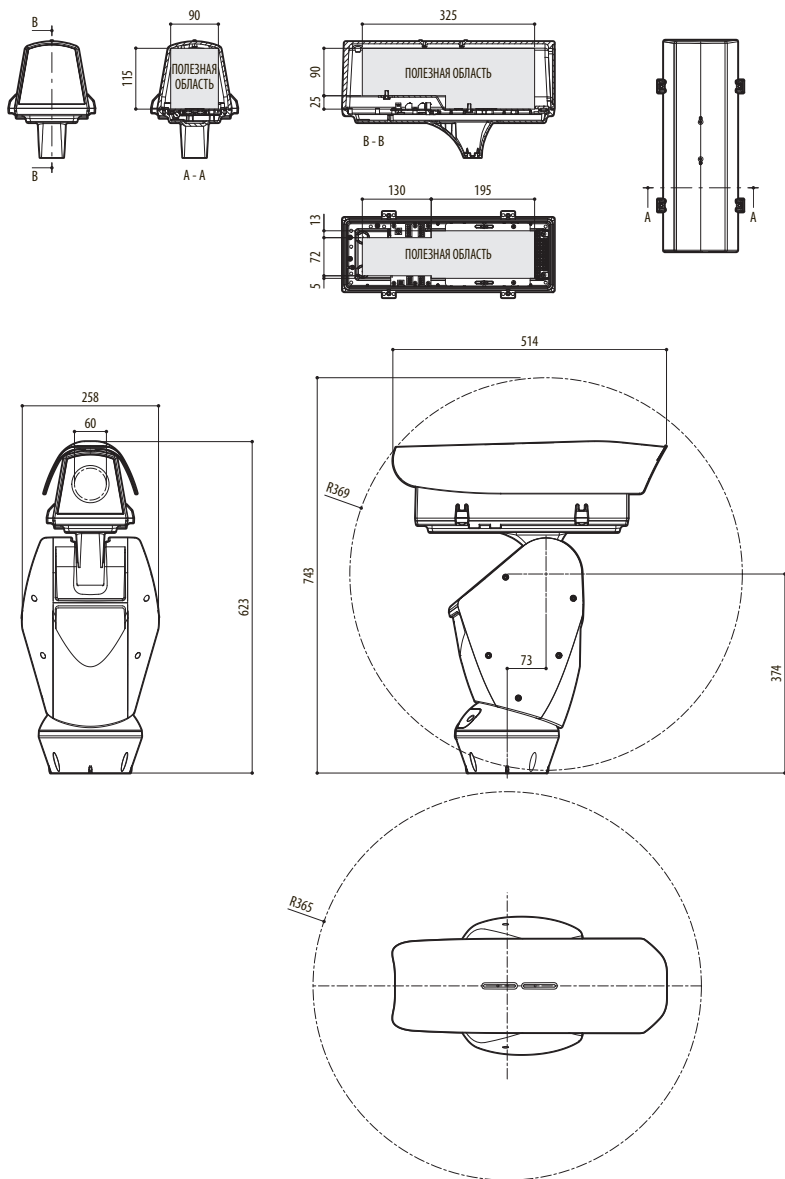
Ниже перечислены все возможные комбинации.

УСТАНОВКА АДРЕСА (DIP 3)

SW 8	SW 7	SW 6	SW 5	SW 4	SW 3	SW 2	SW 1	Адрес
OFF	OFF	OFF	OFF	OFF	OFF	OFF	OFF	Адрес недействительный
OFF	OFF	OFF	OFF	OFF	OFF	OFF	ON	Адрес 1
OFF	OFF	OFF	OFF	OFF	OFF	ON	OFF	Адрес 2
OFF	OFF	OFF	OFF	OFF	OFF	ON	ON	Адрес 3
OFF	OFF	OFF	OFF	OFF	ON	OFF	OFF	Адрес 4
OFF	OFF	OFF	OFF	OFF	ON	OFF	ON	Адрес 5
OFF	OFF	OFF	OFF	OFF	ON	ON	OFF	Адрес 6
OFF	OFF	OFF	OFF	OFF	ON	ON	ON	Адрес 7
OFF	OFF	OFF	OFF	ON	OFF	OFF	OFF	Адрес 8
OFF	OFF	OFF	OFF	ON	OFF	OFF	ON	Адрес 9
OFF	OFF	OFF	OFF	ON	OFF	ON	OFF	Адрес 10
OFF	OFF	OFF	OFF	ON	OFF	ON	ON	Адрес 11
OFF	OFF	OFF	OFF	ON	ON	OFF	OFF	Адрес 12
OFF	OFF	OFF	OFF	ON	ON	OFF	ON	Адрес 13
OFF	OFF	OFF	OFF	ON	ON	ON	OFF	Адрес 14
OFF	OFF	OFF	OFF	ON	ON	ON	ON	Адрес 15
OFF	OFF	OFF	ON	OFF	OFF	OFF	OFF	Адрес 16
OFF	OFF	OFF	ON	OFF	OFF	OFF	ON	Адрес 17
OFF	OFF	OFF	ON	OFF	OFF	ON	OFF	Адрес 18
OFF	OFF	OFF	ON	OFF	OFF	ON	ON	Адрес 19
OFF	OFF	OFF	ON	OFF	ON	OFF	OFF	Адрес 20
OFF	OFF	OFF	ON	OFF	ON	OFF	ON	Адрес 21
OFF	OFF	OFF	ON	OFF	ON	ON	OFF	Адрес 22
OFF	OFF	OFF	ON	OFF	ON	ON	ON	Адрес 23
OFF	OFF	OFF	ON	ON	OFF	OFF	OFF	Адрес 24
OFF	OFF	OFF	ON	ON	OFF	OFF	ON	Адрес 25
OFF	OFF	OFF	ON	ON	OFF	ON	OFF	Адрес 26
OFF	OFF	OFF	ON	ON	OFF	ON	ON	Адрес 27
OFF	OFF	OFF	ON	ON	ON	OFF	OFF	Адрес 28
OFF	OFF	OFF	ON	ON	ON	OFF	ON	Адрес 29
OFF	OFF	OFF	ON	ON	ON	ON	OFF	Адрес 30
OFF	OFF	OFF	ON	ON	ON	ON	ON	Адрес 31
OFF	OFF	ON	OFF	OFF	OFF	OFF	OFF	Адрес 32
OFF	OFF	ON	OFF	OFF	OFF	OFF	ON	Адрес 33
OFF	OFF	ON	OFF	OFF	OFF	ON	OFF	Адрес 34
OFF	OFF	ON	OFF	OFF	OFF	ON	ON	Адрес 35
OFF	OFF	ON	OFF	OFF	ON	OFF	OFF	Адрес 36
OFF	OFF	ON	OFF	OFF	ON	OFF	ON	Адрес 37
OFF	OFF	ON	OFF	OFF	ON	ON	OFF	Адрес 38

УСТАНОВКА АДРЕСА (DIP 3)

SW 8	SW 7	SW 6	SW 5	SW 4	SW 3	SW 2	SW 1	Адрес
OFF	OFF	ON	OFF	OFF	ON	ON	ON	Адрес 39
OFF	OFF	ON	OFF	ON	OFF	OFF	OFF	Адрес 40
OFF	OFF	ON	OFF	ON	OFF	OFF	ON	Адрес 41
OFF	OFF	ON	OFF	ON	OFF	ON	OFF	Адрес 42
OFF	OFF	ON	OFF	ON	OFF	ON	ON	Адрес 43
OFF	OFF	ON	OFF	ON	ON	OFF	OFF	Адрес 44
OFF	OFF	ON	OFF	ON	ON	OFF	ON	Адрес 45
OFF	OFF	ON	OFF	ON	ON	ON	OFF	Адрес 46
OFF	OFF	ON	OFF	ON	ON	ON	ON	Адрес 47
OFF	OFF	ON	ON	OFF	OFF	OFF	OFF	Адрес 48
OFF	OFF	ON	ON	OFF	OFF	OFF	ON	Адрес 49
OFF	OFF	ON	ON	OFF	OFF	ON	OFF	Адрес 50
OFF	OFF	ON	ON	OFF	OFF	ON	ON	Адрес 51
OFF	OFF	ON	ON	OFF	ON	OFF	OFF	Адрес 52
OFF	OFF	ON	ON	OFF	ON	OFF	ON	Адрес 53
OFF	OFF	ON	ON	OFF	ON	ON	OFF	Адрес 54
OFF	OFF	ON	ON	OFF	ON	ON	ON	Адрес 55
OFF	OFF	ON	ON	ON	OFF	OFF	OFF	Адрес 56
OFF	OFF	ON	ON	ON	OFF	OFF	ON	Адрес 57
OFF	OFF	ON	ON	ON	OFF	ON	OFF	Адрес 58
OFF	OFF	ON	ON	ON	OFF	ON	ON	Адрес 59
OFF	OFF	ON	ON	ON	ON	OFF	OFF	Адрес 60
OFF	OFF	ON	ON	ON	ON	OFF	ON	Адрес 61
OFF	OFF	ON	ON	ON	ON	ON	OFF	Адрес 62
OFF	OFF	ON	ON	ON	ON	ON	ON	Адрес 63
OFF	ON	OFF	OFF	OFF	OFF	OFF	OFF	Адрес 64
OFF	ON	OFF	OFF	OFF	OFF	OFF	ON	Адрес 65
OFF	ON	OFF	OFF	OFF	OFF	ON	OFF	Адрес 66
OFF	ON	OFF	OFF	OFF	OFF	ON	ON	Адрес 67
OFF	ON	OFF	OFF	OFF	ON	OFF	OFF	Адрес 68
OFF	ON	OFF	OFF	OFF	ON	OFF	ON	Адрес 69
OFF	ON	OFF	OFF	OFF	ON	ON	OFF	Адрес 70
OFF	ON	OFF	OFF	OFF	ON	ON	ON	Адрес 71
OFF	ON	OFF	OFF	ON	OFF	OFF	OFF	Адрес 72
OFF	ON	OFF	OFF	ON	OFF	OFF	ON	Адрес 73
OFF	ON	OFF	OFF	ON	OFF	ON	OFF	Адрес 74
OFF	ON	OFF	OFF	ON	OFF	ON	ON	Адрес 75
OFF	ON	OFF	OFF	ON	ON	OFF	OFF	Адрес 76
OFF	ON	OFF	OFF	ON	ON	OFF	ON	Адрес 77
OFF	ON	OFF	OFF	ON	ON	ON	OFF	Адрес 78
OFF	ON	OFF	OFF	ON	ON	ON	ON	Адрес 79
OFF	ON	OFF	ON	OFF	OFF	OFF	OFF	Адрес 80
OFF	ON	OFF	ON	OFF	OFF	OFF	ON	Адрес 81
OFF	ON	OFF	ON	OFF	OFF	ON	OFF	Адрес 82

УСТАНОВКА АДРЕСА (DIP 3)								
SW 8	SW 7	SW 6	SW 5	SW 4	SW 3	SW 2	SW 1	Адрес
OFF	ON	OFF	ON	OFF	OFF	ON	ON	Адрес 83
OFF	ON	OFF	ON	OFF	ON	OFF	OFF	Адрес 84
OFF	ON	OFF	ON	OFF	ON	OFF	ON	Адрес 85
OFF	ON	OFF	ON	OFF	ON	ON	OFF	Адрес 86
OFF	ON	OFF	ON	OFF	ON	ON	ON	Адрес 87
OFF	ON	OFF	ON	ON	OFF	OFF	OFF	Адрес 88
OFF	ON	OFF	ON	ON	OFF	ON	OFF	Адрес 89
OFF	ON	OFF	ON	ON	OFF	ON	OFF	Адрес 90
OFF	ON	OFF	ON	ON	OFF	ON	ON	Адрес 91
OFF	ON	OFF	ON	ON	ON	OFF	OFF	Адрес 92
OFF	ON	OFF	ON	ON	ON	OFF	ON	Адрес 93
OFF	ON	OFF	ON	ON	ON	ON	OFF	Адрес 94
OFF	ON	OFF	ON	ON	ON	ON	ON	Адрес 95
OFF	ON	ON	OFF	OFF	OFF	OFF	OFF	Адрес 96
OFF	ON	ON	OFF	OFF	OFF	OFF	ON	Адрес 97
OFF	ON	ON	OFF	OFF	OFF	ON	OFF	Адрес 98
OFF	ON	ON	OFF	OFF	OFF	ON	ON	Адрес 99
OFF	ON	ON	OFF	OFF	ON	OFF	OFF	Адрес 100
OFF	ON	ON	OFF	OFF	ON	OFF	ON	Адрес 101
OFF	ON	ON	OFF	OFF	ON	ON	OFF	Адрес 102
OFF	ON	ON	OFF	OFF	ON	ON	ON	Адрес 103
OFF	ON	ON	OFF	ON	OFF	OFF	OFF	Адрес 104
OFF	ON	ON	OFF	ON	OFF	OFF	ON	Адрес 105
OFF	ON	ON	OFF	ON	OFF	ON	OFF	Адрес 106
OFF	ON	ON	OFF	ON	OFF	ON	ON	Адрес 107
OFF	ON	ON	OFF	ON	ON	OFF	OFF	Адрес 108
OFF	ON	ON	OFF	ON	ON	OFF	ON	Адрес 109
OFF	ON	ON	OFF	ON	ON	ON	OFF	Адрес 110
OFF	ON	ON	OFF	ON	ON	ON	ON	Адрес 111
OFF	ON	ON	ON	OFF	OFF	OFF	OFF	Адрес 112
OFF	ON	ON	ON	OFF	OFF	OFF	ON	Адрес 113
OFF	ON	ON	ON	OFF	OFF	ON	OFF	Адрес 114
OFF	ON	ON	ON	OFF	OFF	ON	ON	Адрес 115
OFF	ON	ON	ON	OFF	ON	OFF	OFF	Адрес 116
OFF	ON	ON	ON	OFF	ON	OFF	ON	Адрес 117
OFF	ON	ON	ON	OFF	ON	ON	OFF	Адрес 118
OFF	ON	ON	ON	OFF	ON	ON	ON	Адрес 119
OFF	ON	ON	ON	ON	OFF	OFF	OFF	Адрес 120
OFF	ON	ON	ON	ON	OFF	OFF	ON	Адрес 121
OFF	ON	ON	ON	ON	OFF	ON	OFF	Адрес 122
OFF	ON	ON	ON	ON	OFF	ON	ON	Адрес 123
OFF	ON	ON	ON	ON	ON	OFF	OFF	Адрес 124
OFF	ON	ON	ON	ON	ON	OFF	ON	Адрес 125
OFF	ON	ON	ON	ON	ON	ON	OFF	Адрес 126

УСТАНОВКА АДРЕСА (DIP 3)

SW 8	SW 7	SW 6	SW 5	SW 4	SW 3	SW 2	SW 1	Адрес
OFF	ON	ON	ON	ON	ON	ON	ON	Адрес 127
ON	OFF	OFF	OFF	OFF	OFF	OFF	OFF	Адрес 128
ON	OFF	OFF	OFF	OFF	OFF	OFF	ON	Адрес 129
ON	OFF	OFF	OFF	OFF	OFF	ON	OFF	Адрес 130
ON	OFF	OFF	OFF	OFF	OFF	ON	ON	Адрес 131
ON	OFF	OFF	OFF	OFF	ON	OFF	OFF	Адрес 132
ON	OFF	OFF	OFF	OFF	ON	OFF	ON	Адрес 133
ON	OFF	OFF	OFF	OFF	ON	ON	OFF	Адрес 134
ON	OFF	OFF	OFF	OFF	ON	ON	ON	Адрес 135
ON	OFF	OFF	OFF	ON	OFF	OFF	OFF	Адрес 136
ON	OFF	OFF	OFF	ON	OFF	OFF	ON	Адрес 137
ON	OFF	OFF	OFF	ON	OFF	ON	OFF	Адрес 138
ON	OFF	OFF	OFF	ON	OFF	ON	ON	Адрес 139
ON	OFF	OFF	OFF	ON	ON	OFF	OFF	Адрес 140
ON	OFF	OFF	OFF	ON	ON	OFF	ON	Адрес 141
ON	OFF	OFF	OFF	ON	ON	ON	OFF	Адрес 142
ON	OFF	OFF	OFF	ON	ON	ON	ON	Адрес 143
ON	OFF	OFF	ON	OFF	OFF	OFF	OFF	Адрес 144
ON	OFF	OFF	ON	OFF	OFF	OFF	ON	Адрес 145
ON	OFF	OFF	ON	OFF	OFF	ON	OFF	Адрес 146
ON	OFF	OFF	ON	OFF	OFF	ON	ON	Адрес 147
ON	OFF	OFF	ON	OFF	ON	OFF	OFF	Адрес 148
ON	OFF	OFF	ON	OFF	ON	OFF	ON	Адрес 149
ON	OFF	OFF	ON	OFF	ON	ON	OFF	Адрес 150
ON	OFF	OFF	ON	ON	OFF	OFF	OFF	Адрес 151
ON	OFF	OFF	ON	ON	OFF	OFF	ON	Адрес 152
ON	OFF	OFF	ON	ON	OFF	ON	OFF	Адрес 153
ON	OFF	OFF	ON	ON	OFF	ON	ON	Адрес 154
ON	OFF	OFF	ON	ON	ON	OFF	OFF	Адрес 155
ON	OFF	OFF	ON	ON	ON	ON	ON	Адрес 156
ON	OFF	OFF	ON	ON	ON	OFF	ON	Адрес 157
ON	OFF	OFF	ON	ON	ON	ON	OFF	Адрес 158
ON	OFF	OFF	ON	ON	ON	ON	ON	Адрес 159
ON	OFF	ON	OFF	OFF	OFF	OFF	OFF	Адрес 160
ON	OFF	ON	OFF	OFF	OFF	OFF	ON	Адрес 161
ON	OFF	ON	OFF	OFF	OFF	ON	OFF	Адрес 162
ON	OFF	ON	OFF	OFF	OFF	ON	ON	Адрес 163
ON	OFF	ON	OFF	OFF	ON	OFF	OFF	Адрес 164
ON	OFF	ON	OFF	OFF	ON	OFF	ON	Адрес 165
ON	OFF	ON	OFF	OFF	ON	ON	OFF	Адрес 166
ON	OFF	ON	OFF	OFF	ON	ON	ON	Адрес 167
ON	OFF	ON	OFF	ON	OFF	OFF	OFF	Адрес 168
ON	OFF	ON	OFF	ON	OFF	OFF	ON	Адрес 169
ON	OFF	ON	OFF	ON	OFF	ON	OFF	Адрес 170

УСТАНОВКА АДРЕСА (DIP 3)								
SW 8	SW 7	SW 6	SW 5	SW 4	SW 3	SW 2	SW 1	Адрес
ON	OFF	ON	OFF	ON	OFF	ON	ON	Адрес 171
ON	OFF	ON	OFF	ON	ON	OFF	OFF	Адрес 172
ON	OFF	ON	OFF	ON	ON	OFF	ON	Адрес 173
ON	OFF	ON	OFF	ON	ON	ON	OFF	Адрес 174
ON	OFF	ON	OFF	ON	ON	ON	ON	Адрес 175
ON	OFF	ON	ON	OFF	OFF	OFF	OFF	Адрес 176
ON	OFF	ON	ON	OFF	OFF	OFF	ON	Адрес 177
ON	OFF	ON	ON	OFF	OFF	ON	OFF	Адрес 178
ON	OFF	ON	ON	OFF	OFF	ON	ON	Адрес 179
ON	OFF	ON	ON	OFF	ON	OFF	OFF	Адрес 180
ON	OFF	ON	ON	OFF	ON	OFF	ON	Адрес 181
ON	OFF	ON	ON	OFF	ON	ON	OFF	Адрес 182
ON	OFF	ON	ON	OFF	ON	ON	ON	Адрес 183
ON	OFF	ON	ON	ON	OFF	OFF	OFF	Адрес 184
ON	OFF	ON	ON	ON	OFF	OFF	ON	Адрес 185
ON	OFF	ON	ON	ON	OFF	ON	OFF	Адрес 186
ON	OFF	ON	ON	ON	OFF	ON	ON	Адрес 187
ON	OFF	ON	ON	ON	ON	OFF	OFF	Адрес 188
ON	OFF	ON	ON	ON	ON	OFF	ON	Адрес 189
ON	OFF	ON	ON	ON	ON	ON	OFF	Адрес 190
ON	OFF	ON	ON	ON	ON	ON	ON	Адрес 191
ON	ON	OFF	OFF	OFF	OFF	OFF	OFF	Адрес 192
ON	ON	OFF	OFF	OFF	OFF	OFF	ON	Адрес 193
ON	ON	OFF	OFF	OFF	OFF	ON	OFF	Адрес 194
ON	ON	OFF	OFF	OFF	OFF	ON	ON	Адрес 195
ON	ON	OFF	OFF	OFF	ON	OFF	OFF	Адрес 196
ON	ON	OFF	OFF	OFF	ON	OFF	ON	Адрес 197
ON	ON	OFF	OFF	OFF	ON	ON	OFF	Адрес 198
ON	ON	OFF	OFF	OFF	ON	ON	ON	Адрес 199
ON	ON	OFF	OFF	ON	OFF	OFF	OFF	Адрес 200
ON	ON	OFF	OFF	ON	OFF	OFF	ON	Адрес 201
ON	ON	OFF	OFF	ON	OFF	ON	OFF	Адрес 202
ON	ON	OFF	OFF	ON	OFF	ON	ON	Адрес 203
ON	ON	OFF	OFF	ON	ON	OFF	OFF	Адрес 204
ON	ON	OFF	OFF	ON	ON	OFF	ON	Адрес 205
ON	ON	OFF	OFF	ON	ON	ON	OFF	Адрес 206
ON	ON	OFF	OFF	ON	ON	ON	ON	Адрес 207
ON	ON	OFF	ON	OFF	OFF	OFF	OFF	Адрес 208
ON	ON	OFF	ON	OFF	OFF	OFF	ON	Адрес 209
ON	ON	OFF	ON	OFF	OFF	ON	OFF	Адрес 210
ON	ON	OFF	ON	OFF	OFF	ON	ON	Адрес 211
ON	ON	OFF	ON	OFF	ON	OFF	OFF	Адрес 212
ON	ON	OFF	ON	OFF	ON	OFF	ON	Адрес 213
ON	ON	OFF	ON	OFF	ON	ON	OFF	Адрес 214

УСТАНОВКА АДРЕСА (DIP 3)								
SW 8	SW 7	SW 6	SW 5	SW 4	SW 3	SW 2	SW 1	Адрес
ON	ON	OFF	ON	OFF	ON	ON	ON	Адрес 215
ON	ON	OFF	ON	ON	OFF	OFF	OFF	Адрес 216
ON	ON	OFF	ON	ON	OFF	OFF	ON	Адрес 217
ON	ON	OFF	ON	ON	OFF	ON	OFF	Адрес 218
ON	ON	OFF	ON	ON	OFF	ON	ON	Адрес 219
ON	ON	OFF	ON	ON	ON	OFF	OFF	Адрес 220
ON	ON	OFF	ON	ON	ON	OFF	ON	Адрес 221
ON	ON	OFF	ON	ON	ON	ON	OFF	Адрес 222
ON	ON	OFF	ON	ON	ON	ON	ON	Адрес 223
ON	ON	ON	OFF	OFF	OFF	OFF	OFF	Адрес 224
ON	ON	ON	OFF	OFF	OFF	OFF	ON	Адрес 225
ON	ON	ON	OFF	OFF	OFF	ON	OFF	Адрес 226
ON	ON	ON	OFF	OFF	OFF	ON	ON	Адрес 227
ON	ON	ON	OFF	OFF	ON	OFF	OFF	Адрес 228
ON	ON	ON	OFF	OFF	ON	OFF	ON	Адрес 229
ON	ON	ON	OFF	OFF	ON	ON	OFF	Адрес 230
ON	ON	ON	OFF	OFF	ON	ON	ON	Адрес 231
ON	ON	ON	OFF	ON	OFF	OFF	OFF	Адрес 232
ON	ON	ON	OFF	ON	OFF	OFF	ON	Адрес 233
ON	ON	ON	OFF	ON	OFF	ON	OFF	Адрес 234
ON	ON	ON	OFF	ON	OFF	ON	ON	Адрес 235
ON	ON	ON	OFF	ON	ON	OFF	OFF	Адрес 236
ON	ON	ON	OFF	ON	ON	OFF	ON	Адрес 237
ON	ON	ON	OFF	ON	ON	ON	OFF	Адрес 238
ON	ON	ON	OFF	ON	ON	ON	ON	Адрес 239
ON	ON	ON	ON	OFF	OFF	OFF	OFF	Адрес 240
ON	ON	ON	ON	OFF	OFF	OFF	ON	Адрес 241
ON	ON	ON	ON	OFF	OFF	ON	OFF	Адрес 242
ON	ON	ON	ON	OFF	OFF	ON	ON	Адрес 243
ON	ON	ON	ON	OFF	ON	OFF	OFF	Адрес 244
ON	ON	ON	ON	OFF	ON	OFF	ON	Адрес 245
ON	ON	ON	ON	OFF	ON	ON	OFF	Адрес 246
ON	ON	ON	ON	OFF	ON	ON	ON	Адрес 247
ON	ON	ON	ON	ON	OFF	OFF	OFF	Адрес 248
ON	ON	ON	ON	ON	OFF	OFF	ON	Адрес 249
ON	ON	ON	ON	ON	OFF	ON	OFF	Адрес 250
ON	ON	ON	ON	ON	OFF	ON	ON	Адрес 251
ON	ON	ON	ON	ON	ON	OFF	OFF	Адрес 252
ON	ON	ON	ON	ON	ON	OFF	ON	Адрес 253
ON	ON	ON	ON	ON	ON	ON	OFF	Адрес 254
ON	ON	ON	ON	ON	ON	ON	ON	Адрес 255

Таб. 16

Headquarters Italy Videotec S.p.A.

Via Friuli, 6 - I-36015 Schio (VI) - Italy

Tel. +39 0445 697411 - Fax +39 0445 697414

Email: info@videotec.com

Asia Pacific Videotec (HK) Ltd

Flat 8, 19/F. On Dak Industrial Building, No. 2-6 Wah Sing Street

Kwai Chung, New Territories - Hong Kong

Tel. +852 2333 0601 - Fax +852 2311 0026

Email: info.hk@videotec.com

France Videotec France SARL

Immeuble Le Montreal, 19bis Avenue du Québec, ZA de Courtaboeuf
91140 Villebon sur Yvette - France

Tel. +33 1 60491816 - Fax +33 1 69284736

Email: info.fr@videotec.com

Americas Videotec Security, Inc.

Gateway Industrial Park, 35 Gateway Drive, Suite 100
Plattsburgh, NY 12901 - U.S.A.

Tel. +1 518 825 0020 - Fax +1 518 825 0022

Email: info.usa@videotec.com - www.videotec.us



www.videotec.com

MNVCUPTPLUS3_1511_RU

Headquarters Italy Videotec S.p.A.

Via Friuli, 6 - I-36015 Schio (VI) - Italy

Tel. +39 0445 697411 - Fax +39 0445 697414

Email: info@videotec.com

Asia Pacific Videotec (HK) Ltd

Flat 8, 19/F. On Dak Industrial Building, No. 2-6 Wah Sing Street

Kwai Chung, New Territories - Hong Kong

Tel. +852 2333 0601 - Fax +852 2311 0026

Email: info.hk@videotec.com

France Videotec France SARL

Immeuble Le Montreal, 19bis Avenue du Québec, ZA de Courtaboeuf
91140 Villebon sur Yvette - France

Tel. +33 1 60491816 - Fax +33 1 69284736

Email: info.fr@videotec.com

Americas Videotec Security, Inc.

Gateway Industrial Park, 35 Gateway Drive, Suite 100
Plattsburgh, NY 12901 - U.S.A.

Tel. +1 518 825 0020 - Fax +1 518 825 0022

Email: info.usa@videotec.com - www.videotec.us



www.videotec.com

MNVCUPTPLUS3_1511