

WASEX

EXPLOSION-PROOF WASH SYSTEM



IP66



WASEX



WASEX

DESCRIPTION

The WASEX washer pump is an important element for effective video surveillance in hazardous areas because it guarantees sharp images in all environmental conditions and reduces the need for maintenance.

The WASEX system is designed for the MAXIMUS series.

The kit is composed of a 10-litre stainless steel tank with an explosion-proof certified solenoid valve and some versions of the product also have an explosion-proof certified pressure switch.

The pressure switch is used to control the pressure in the tank.

Some versions of the WASEX product are Lloyd's Register Type Approval System Test Specification Number 1 certified and therefore can be used in Marine and Offshore applications for environmental categories ENV1, ENV2, ENV3 and ENV5.

CERTIFICATIONS



MAIN FEATURES

Maximum delivery: 30m (98ft) (antistatic water delivery pipe supplied, 20m (66ft))

Water tank capacity: 10l (2.6gal)

Suitable for MAXIMUS series

TECHNICAL DATA

MECHANICAL

Materials:

- External enclosure: stainless steel AISI 316L
- Antistatic water delivery pipe: antistatic polymer

Antistatic water delivery pipe (supplied):

- Length: 20m (66ft)

Schrader type compressed air filling valve

Pressure: 6bar max

Delivery:

- 20m (66ft), 4bar (with 20m water delivery antistatic pipe supplied)
- 30m (98ft), 6bar (with 30m water delivery antistatic pipe available as an accessory)

Water tank capacity: 10l (2.6gal)

Cable inputs:

- 1 x 1/2" NPT (WASEX2T4AT, WASEX2T4GOR, WASEX2T4IC, WASEX2T4IN, WASEX2T4KC, WASEX2T4UL)
- 2 x 1/2" NPT (WASEX2T4ATPR)

Dimensions (WxHxL): 429x697x255mm (16.9x27.4x10in)

Unit weight: 18kg (40lb) (WASEX2T4AT, WASEX2T4GOR, WASEX2T4IC, WASEX2T4IN, WASEX2T4KC, WASEX2T4UL); 20Kg (WASEX2T4ATPR)

ELECTRICAL

WASEX2T4AT, WASEX2T4GOR, WASEX2T4IC, WASEX2T4IN, WASEX2T4UL

Solenoid valve:

- Power supply: 24Vac, 50/60Hz or 24Vdc
- Consumption: 5W

WASEX2T4ATPR

Solenoid valve:

- Power supply: 24Vac, 50/60Hz or 24Vdc
- Consumption: 5W

Pressure switch: dry contact for alarm signal management

Consult the use and installation manual of the pressure switch for further information (supplied).

WASEX2T4KC

Solenoid valve:

- Power supply: 24Vdc
- Consumption: 10.6W

ENVIRONMENT

WASEX2T4AT, WASEX2T4GOR, WASEX2T4IC, WASEX2T4IN, WASEX2T4UL

For indoors and outdoors installation

Operating temperature of solenoid valve: from -40°C (-40°F) up to +60°C (140°F)

Operating temperature of device: depending on the solidification temperature of the liquid

Relative humidity: from 5% up to 95%

WASEX2T4ATPR

For indoors and outdoors installation

Operating temperature of solenoid valve: from -40°C (-40°F) up to +60°C (140°F)

Pressure switch working temperature: from -40°C (-40°F) up to +80°C (+176°F)

Operating temperature of device: depending on the solidification temperature of the liquid

Relative humidity: from 5% up to 95%

WASEX2T4KC

For indoors and outdoors installation

Operating temperature of solenoid valve: from -40°C (-40°F) up to +55°C (131°F)

Operating temperature of device: depending on the solidification temperature of the liquid

Relative humidity: from 5% up to 95%

CERTIFICATIONS - EXPLOSION-PROOF APPLICATIONS

For further details on certifications and markings, consult the relevant table.

CERTIFICATIONS - MARINE APPLICATIONS

WASEX2T4AT, WASEX2T4GOR, WASEX2T4IN, WASEX2T4KC

Salty fog resistance: EN60068-2-52

Lloyd's Register Marine Type Approval certification:

- Test Specification Number 1 (ENV1, ENV2, ENV3, ENV5)

Tested at 70°C (158°F) for 16 hours in compliance with EN60068-2-2

PART NUMBER

WASEX2T4AT	10l tank with integrated manual pump, controlled by a certified solenoid valve (ATEX), delivery head up to 30m (98ft), with 20m (66ft) antistatic water delivery pipe, IN 24Vac/24Vdc
WASEX2T4ATPR	10l tank with integrated manual pump, controlled by a certified solenoid valve and pressure switch (ATEX), delivery head up to 30m (98ft), with 20m (66ft) antistatic water delivery pipe, IN 24Vac/24Vdc
WASEX2T4GOR	10l tank with integrated manual pump, controlled by a certified solenoid valve (EAC Ex), delivery head up to 30m (98ft), with 20m (66ft) antistatic water delivery pipe, IN 24Vac/24Vdc
WASEX2T4IC	10l tank with integrated manual pump, controlled by a certified solenoid valve (ATEX, IECEx), delivery head up to 30m (98ft), with 20m (66ft) antistatic water delivery pipe, IN 24Vac/24Vdc
WASEX2T4IN	10l tank with integrated manual pump, controlled by a certified solenoid valve (INMETRO), delivery head up to 30m (98ft), with 20m (66ft) antistatic water delivery pipe, IN 24Vac/24Vdc
WASEX2T4KC	10l tank with integrated manual pump, controlled by a certified solenoid valve (KCs), delivery head up to 30m (98ft), with 20m (66ft) antistatic water delivery pipe, IN 24Vdc
WASEX2T4UL	10l tank with integrated manual pump, controlled by a certified solenoid valve (cULus), delivery head up to 30m (98ft), with 20m (66ft) antistatic water delivery pipe, IN 24Vac/24Vdc

ACCESSORIES	
MBX1MAA	Explosion-proof communication box in stainless steel, IN 230Vac, with EMC filter for marine certification
MBX2MAA	Explosion-proof communication box in stainless steel, IN 24Vac, with EMC filter for marine certification
MBX3MAA	Explosion-proof communication box in stainless steel, IN 120Vac, with EMC filter for marine certification
MBA1SSA	Explosion-proof communication box in aluminium, IN 230Vac
MBA2SSA	Explosion-proof communication box in aluminium, IN 24Vac
MBA3SSA	Explosion-proof communication box in aluminium, IN 120Vac
OCTEX1/2C	Cable gland in nickel-plated brass EX 1/2" NPT unarmoured cable IECEx-ATEX-EAC Ex
OCTEXS1/2C	Cable gland in nickel-plated brass EX 1/2" NPT, unarmoured cable IECEx-ATEX-EAC Ex
OCTEXB1/2C	Barrier cable gland in nickel-plated brass EX 1/2" NPT unarmoured cable IECEx-ATEX-EAC Ex
OCTEXB1/2P	Barrier cable gland in nickel-plated brass EX 1/2" NPT, unarmoured cable IECEx-ATEX-EAC Ex
OCTEXBA1/2P	Barrier cable gland in nickel-plated brass EX 1/2" NPT, armoured cable IECEx-ATEX-EAC Ex
OCTEXA1/2C	Cable gland in nickel-plated brass EX 1/2" NPT armoured cable IECEx-ATEX-EAC Ex
WEXTUB30	Antistatic water delivery pipe, 30m (98ft)

For further details about cable glands part numbers, please refer to the relevant table.

BRACKETS AND ADAPTORS	
NXCOL	AISI 316L stainless steel pole adapter module
NXCW	AISI 316L stainless steel corner adapter module

SPARE PARTS	
OWEXELE24	Solenoid valve 24Vac/Vdc, ATEX certified
OWEXELE24GOR	Solenoid valve 24Vac/Vdc, EAC Ex certified
OWEXELE24INM	Solenoid valve 24Vac/Vdc, INMETRO certified
OWEXMANB	1/8" pressure gauge
OWEXTANKB	Pump in stainless steel, 10l (2.6gal)
OWEXTUB	Antistatic water delivery pipe, 20m (66ft)
OWEXPSW	ATEX certified pressure switch

PACKAGE			
Model Number	Weight	Dimensions (WxHxL)	Master carton
WASEX2T4AT	20.3kg (44.7lb)	30x74x46cm (11.8x29.1x18.1in)	-
WASEX2T4ATPR	22.3kg (49.2lb)	30x74x46cm (11.8x29.1x18.1in)	-

WASEX - CERTIFICATIONS AND MARKINGS			
Part number	Certification	Marking	Ambient temperature
WASEX2T4AT	ATEX (Solenoid valve)	⊕ 2 II GD Ex d IIC T6 or T5 or T4 Gb Ex tb IIIC T80°C or 95°C or T130°C Db IP66	-40°C ≤ Ta ≤ +35°C or +50°C or +60°C
WASEX2T4GOR	EAC Ex (Pumping unit)	II Gb c IIC T6...T4 X III Db c IIIC T85°C...T130°C X	-40°C ≤ Ta ≤ +35°C or +50°C or +60°C
	EAC Ex (Solenoid valve)	1Ex db IIC T6...T4 Gb X Ex tb IIIC T80°C...T130°C Db	-40°C ≤ Ta ≤ +35°C or +50°C or +60°C
WASEX2T4IC	ATEX (Solenoid valve)	⊕ II 2G Ex db IIC T6...T4 Gb ⊕ II 2D Ex tb IIIC T85°C...T135°C Db	-60°C ≤ Tamb ≤ +65°C or +80°C or +100°C
	IECEx (Solenoid valve)	Ex db IIC T6...T4 Gb Ex tb IIIC T85°C...T135°C Db	
WASEX2T4IN	INMETRO (Solenoid valve)	Ex d IIC T4 Gb IP66 Ex tb IIIC T135°C Db IP66	-40°C ≤ Ta ≤ +60°C
WASEX2T4KC	ATEX (Solenoid valve)	⊕ 2 II GD Ex db mb IIC T4 Gb Ex mb tb IIIC T135°C Db	-40°C ≤ Ta ≤ +55°C
	IECEx (Solenoid valve)	Ex db mb IIC T4 Gb Ex mb tb IIIC T135°C Db	
	KCs (Solenoid valve)	Ex d mb IIC T4 Ex mb tD A21 IP67 T135°C	
WASEX2T4ATPR ¹	ATEX (Pressure switch)	⊕ 2 II G Ex d IIC T6 Gb Ex d IIC T5 Gb ⊕ 2 II D Ex tb IIIC T 75°C Db Ex tb IIIC T 90°C Db	-35°C ≤ Ta ≤ +65°C or +80°C
	ATEX (Solenoid valve)	⊕ 2 II GD Ex d IIC T6 or T5 or T4 Gb Ex tb IIIC T80°C or 95°C or T130°C Db IP66	-40°C ≤ Ta ≤ +35°C or +50°C or +60°C
WASEX2T4UL	cULus (Solenoid valve)	CLASS I, DIV I, GROUP B, C, D CLASS II, DIV I, GROUP E, F, G CLASS III, DIV I	-60°C ≤ Ta ≤ 55°C FOR T6 -60°C ≤ Ta ≤ 70°C FOR T5 -60°C ≤ Ta ≤ 100°C FOR T4

¹ The assembly can be installed in the following areas:

Zone 1, IIC, T6/T5/T4, ambient temperature from -35°C up to +35°C, +50°C, +60°C.

Zone 21, IIIC, T80°C/T95°C/T130°C, ambient temperature from -35°C up to +35°C, +50°C, +60°C.

CABLE GLANDS AND ACCESSORIES 1/2" NPT

Type	Certification	Operating temperature	Cable	Model Number	Maximum diameter of the external sheath (A)	Maximum diameter of the internal sheath (B)	Maximum diameter of the conductors bundle (C)
Barrier cable gland	IECEX/ATEX/EAC Ex	-60°C (-76°F) / +135°C (+275°F)	Unarmoured cable	OCTEXB1/2P	14.0mm (0.55in)	-	12.5mm (0.5in)
			Armoured cable	OCTEXBA1/2P	15.5 - 21.1mm (0.61-0.83in)	14mm (0.6in) max	12.5mm (0.5in)
Cable gland with gasket	IECEX/ATEX/EAC Ex	-60°C (-76°F) / +100°C (+212°F)	Unarmoured cable	OCTEX1/2C	3.2 - 8.0mm (0.12-0.31in)	-	-
			Unarmoured cable	OCTEXS1/2C	6.5 - 11.9mm (0.26 - 0.47in)	-	-
			Armoured cable	OCTEXA1/2C	12.5 - 20.5mm (0.49 - 0.8in)	10 - 14.3mm (0.4 - 0.56in)	-
Plug EX 1/2"NPT	IECEX/ATEX/EAC Ex	-100°C (-148°F) / +400°C (+752°F)	-	OEXPLUG1/2P	-	-	-

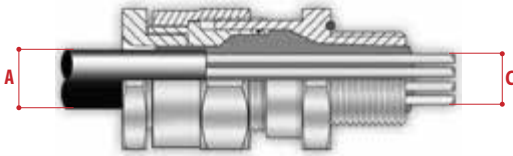

Barrier cable gland with unarmoured cable

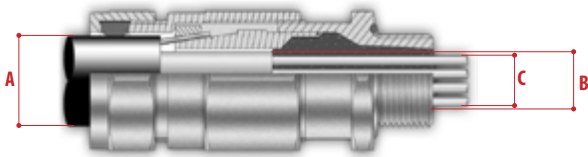

Barrier cable gland with armoured cable

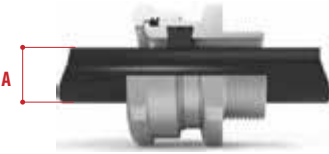

Cable gland with gasket with unarmoured cable



Cable gland with gasket with armoured cable

TECHNICAL DRAWINGS

The indicated measurements are expressed in millimetres.

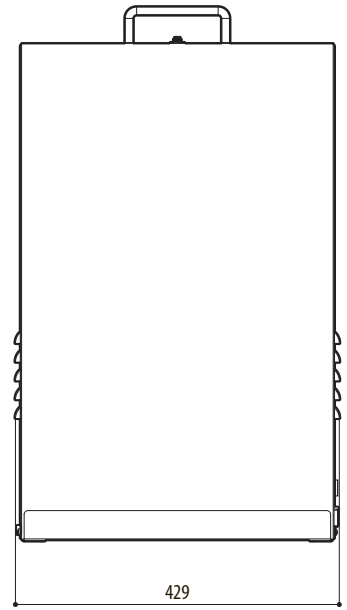
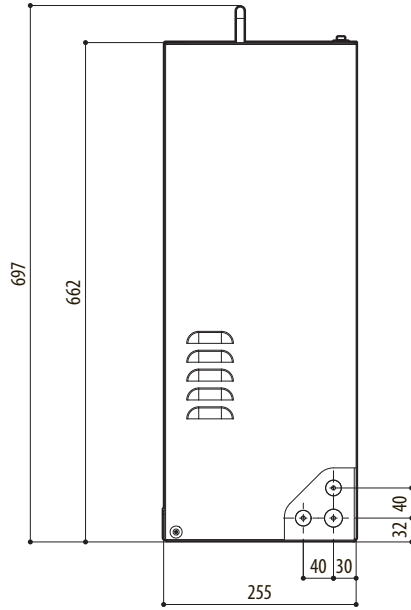
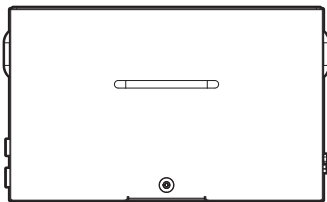
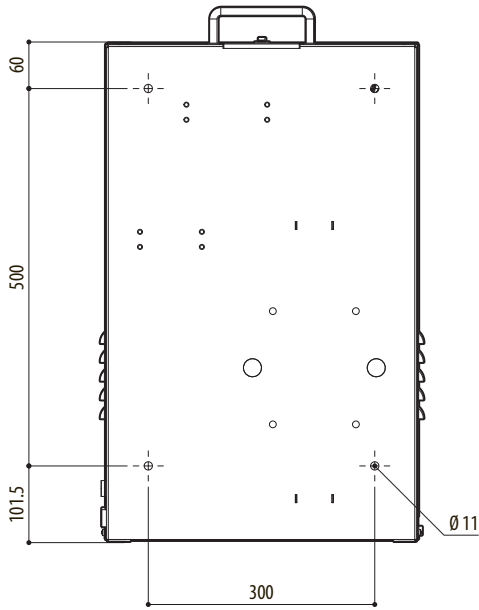
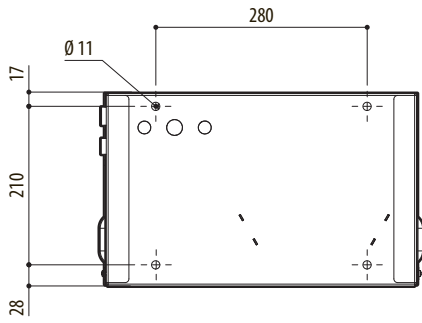

WASEX