

EXH

EX-PROOF HOUSING



EXHC + EXHS000 + EXWBJ

DESCRIPTION

The EXH housings are made with strong Anticorodal aluminium die-cast alloy of AlSi Mg EN AB- 42000 group.

All external components are stove enameled using powder offering an excellent resistance to UV rays, salt-spray, environment polluting substances.

The cylindrical body of the EXHC housing (210mm diameter and 400mm length) is closed on opposite sides by two 12 mm thick flanges. The housing is supplied with two holes for the 3/4" NPT cable glands. The camera housing is equipped with heater and optional sunshield.

CERTIFICATIONS



MAIN FEATURES

Certifications Ex d for use in Zone 1 and 2, Group IIC (Gas), and in Zone Ex tb 21 and 22 (Dust)

Solid anticorodal aluminium construction

IP66

2 holes for cable glands 3/4" NPT

Supplied with heater. Sunshield as option.

Ambient temperature: -40°C/+50°C (-40°C/+122°F) with reinforced heater

GENERAL

Non-corrosive die-cast aluminium (anticorrosive)
Epoxy powder painted with orange peel effect, RAL7032

MECHANICAL

2 holes for cable glands 3/4" NPT

External dimensions:

- EXHC Ø 210mmx427.5mm (8.2x16.8in)

Internal dimensions:

- EXHC Ø 180x380mm (7x14.9in)

Internal usable area:

- EXHC 100x100x280mm (3.9x3.9x11in)

Glass window extra clear:

- EXHC Ø 114mm (4.5in)

Unit weight:

- EXHC 15kg / 33lb

ELECTRICAL

Reinforced heater: Ton 15°C±4°C (59°F±7°F), Toff 22°C±3°C (72°F±5°F)

- 3 resistors in the housing, consumption 60W max

Glass protection device:

- 24Vac, power consumption 2W max

Devices to install inside the housing

- Camera equipped with lens with max total power of 20W
- Voltage max. 24Vac or 230Vac
- Useful volume for camera / lens: 2800cm³
- Minimum distance between the walls of the housing and the camera/lens: 12mm

ENVIRONMENT

For installation indoors and outdoors

Operating temperature with heating: -40°C / +50°C (-40°F/+122°F)

Always refer to the temperature in the marking.

CERTIFICATIONS

Electrical safety (CE): EN62368-1

Electromagnetic compatibility (CE): EN61000-6-3, EN61000-3-2, EN61000-3-3, EN50130-4, EN55032 (Class B)

RoHS (CE): EN50581

Outdoor installation (CE): EN60950-22, ICE60950-22

IP protection degree (EN/IEC60529): IP66

CERTIFICATIONS - EXPLOSION-PROOF APPLICATIONS

ATEX (EN 60079-0+A11, EN 60079-1, EN 60079-31)

IECEX (IEC 60079-0, IEC 60079-1, IEC 60079-31)

EAC EX (TR CU 012/2011)

KCs (Employment and labor department 2016-54)

For further details on certifications and markings, consult the relevant table.

BRACKETS AND ADAPTORS

EXWBJ000 Bracket and ball joint RAL7032 for EXH series

EXBJ000 Only ball joint for EXH RAL7032 housings

ACCESSORIES

EXHS000 Sunshield 580mm (22.8in) for EXH series

OCTEX3/4C Cable gland in nickel-plated brass with gasket EX 3/4" NPT, unarmoured cable IECEX-ATEX-EAC Ex

OCTEXA3/4C Cable gland in nickel-plated brass with gasket EX 3/4" NPT, armoured cable IECEX-ATEX-EAC Ex

OCTEXB3/4C Barrier cable gland in nickel-plated brass 3/4" NPT, unarmoured cable IECEX-ATEX-EAC Ex

OCTEXB3/4P Barrier cable gland in nickel-plated brass EX 3/4" NPT, unarmoured cable IECEX-ATEX-EAC Ex

OCTEXBA3/4P Barrier cable gland in nickel-plated brass EX 3/4" NPT, armoured cable IECEX-ATEX-EAC Ex

OCTEXBA3/4C Barrier cable gland in nickel-plated brass 3/4" NPT, armoured cable IECEX-ATEX-EAC Ex

OCTEX3/4 Cable gland in nickel-plated brass with gasket EX 3/4" NPT, unarmoured cable ATEX

OCTEXA3/4 Cable gland in nickel-plated brass with gasket EX 3/4" NPT, armoured cable ATEX

OCTEXB1/2C Barrier cable gland in nickel-plated brass EX 1/2" NPT, unarmoured cable IECEX-ATEX-EAC Ex

OCTEXB1/2P Barrier cable gland in nickel-plated brass EX 1/2" NPT, unarmoured cable IECEX-ATEX-EAC Ex

OCTEXBA1/2P Barrier cable gland in nickel-plated brass EX 1/2" NPT, armoured cable IECEX-ATEX-EAC Ex

OCTEX1/2C Cable gland in nickel-plated brass EX 1/2" NPT, unarmoured cable IECEX-ATEX-EAC Ex

OCTEXS1/2C Cable gland in nickel-plated brass EX 1/2" NPT, unarmoured cable IECEX-ATEX-EAC Ex

OCTEXA1/2C Cable gland in nickel-plated brass EX 1/2" NPT armoured cable IECEX-ATEX-EAC Ex

OCTEX1/2-3/4P Cable glands reduction in nickel-plated brass Ex 3/4" - 1/2" NPT IECEX-ATEX-EAC Ex

OCTEXP3/4C Conduit cable gland nickel-plated brass 3/4" NPT IECEX-ATEX- c CSA us - EAC Ex (operating temperature: from -60°C (-76°F) up to +80°C (+176°F))

OEXPLUG1/2P Plug EX 1/2" NPT IECEX-ATEX-EAC Ex

OEXPLUG3/4P Plug EX 3/4" NPT IECEX-ATEX-EAC Ex

For further details about cable glands part numbers, please refer to the relevant table.

SPARE PARTS

OEXVETN Complete front flange with glass for EXHC and EXPTEC series

OSLIEC Internal slide complete with heater for EXHC and EXPTEC series

PACKAGE

Model Number	Weight	Dimensions (WxHxL)	Master carton
EXHC003R	17.5kg (39lb)	61x32x31cm (24x12.6x12.2in)	-

SELECTION DIAGRAM FOR CABLE GLANDS AND ACCESSORIES 1/2" NPT

Type	Certification	Operating temperature	Cable	Model Number	Diameter of the external cable	Under armor cable diameter
Barrier cable gland	IECEX/ATEX/EAC Ex	-60°C / +80°C (-76°F / +176°F)	Unarmoured cable	OCTEXB1/2C	3.0 - 8.0mm (0.12-0.31in)	–
			Unarmoured cable	OCTEXB1/2P	12.5 - 14.0mm (0.5-0.55in)	–
			Armoured cable	OCTEXBA1/2P	15.5 - 21.1mm (0.61-0.83in)	–
Cable gland with gasket	IECEX/ATEX/EAC Ex	-60°C / +100°C (-76°F / +212°F)	Unarmoured cable	OCTEX1/2C	3.2 - 8.0mm (0.12-0.31in)	–
			Unarmoured cable	OCTEXS1/2C	6.5 - 11.9mm (0.26 - 0.47in)	–
			Armoured cable	OCTEXA1/2C	12.5 - 20.5mm (0.49 - 0.8in)	10 - 14.3mm (0.4 - 0.56in)
Plug EX 1/2"NPT	IECEX/ATEX/EAC Ex	-100°C (-148°F) / +400°C (752°F)	–	OEXPLUG1/2P	–	–

SELECTION DIAGRAM FOR CABLE GLANDS AND ACCESSORIES 3/4" NPT

Type	Certification	Operating temperature	Cable	Model Number	Diameter of the external cable	Under armor cable diameter
Barrier cable gland	IECEX/ATEX/EAC Ex	-60°C / +80°C (-76°F / +176°F)	Unarmoured cable	OCTEXB3/4C	13.0 - 20.2mm (0.51-0.79in)	–
			Armoured cable	OCTEXBA3/4C	16.9 - 26.0mm (0.66-1.02in)	–
			Unarmoured cable	OCTEXB3/4P	17.8 - 20.0mm (0.70-0.79in)	–
			Armoured cable	OCTEXBA3/4P	16.8 - 23.9mm (0.66-0.94in)	–
Cable gland with gasket	IECEX/ATEX/EAC Ex	-60°C / +100°C (-76°F / +212°F)	Unarmoured cable	OCTEX3/4C	13.0 - 20.2mm (0.51-0.79in)	–
			Armoured cable	OCTEXA3/4C	16.9 - 26.0mm (0.66-1.02in)	11.1 - 19.7mm (0.44 - 0.78in)
	ATEX	-40°C / +100°C (-40°F / +212°F)	Unarmoured cable	OCTEX3/4	14.0 - 17.0mm (0.55-0.67in)	–
			Armoured cable	OCTEXA3/4	18.0 - 23.0mm (0.71-0.91in)	14 - 17mm (0.55 - 0.67in)
Plug EX 3/4"NPT	IECEX/ATEX/EAC Ex	-100°C (-148°F) / +400°C (752°F)	–	OEXPLUG3/4P	–	–
Conduit sealing fitting	IECEX-ATEX- c CSA us - EAC Ex	-60°C / +80°C (-76°F / +176°F)	–	OCTEXP3/4C	–	–
Reduction 3/4" NPT x 1/2" NPT	IECEX/ATEX/EAC Ex	-100°C (-148°F) / +400°C (752°F)	–	OCTEX1/2-3/4P	–	–

EXH - CERTIFICATIONS AND MARKINGS

Certification	Marking
ATEX	⊕ II 2G Ex d IIC T6 Gb ⊕ II 2D Ex t IIIC T85 °C Db IP66
IECEX	Ex d IIC T6 Gb Ex t IIIC T85 °C Db IP66
EAC EX	Ex II 2G Ex d IIC T6 Gb, -40°C/+50°C EX II 2D Ex t IIIC T85°C Db -40°C/+50°C, IP66
KCs	Ex d IIC T6 Ex tb IIIC T85°C

AVAILABLE MODELS

Model Number	Housing heater 24Vac	Housing heater 230Vac	Reinforced heater	Glass protection device	Ambient temperature
EXHC003R	✓	–	✓	–	-40°C / +50°C (-40°F/+122°F)
EXHC203R	–	✓	✓	–	-40°C / +50°C (-40°F/+122°F)

TECHNICAL DRAWINGS

The indicated measurements are expressed in millimetres.

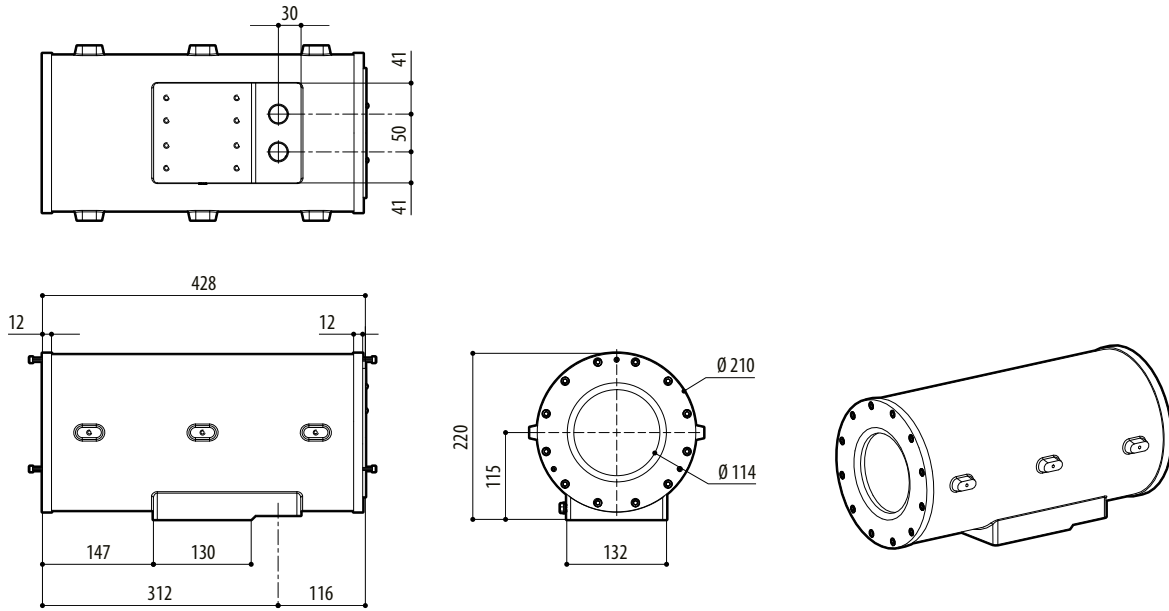

EXHC